

R58BPCRGB1Q

Photoelectric Sensor – Convergent Mode Sensor

Color Mark Sensor

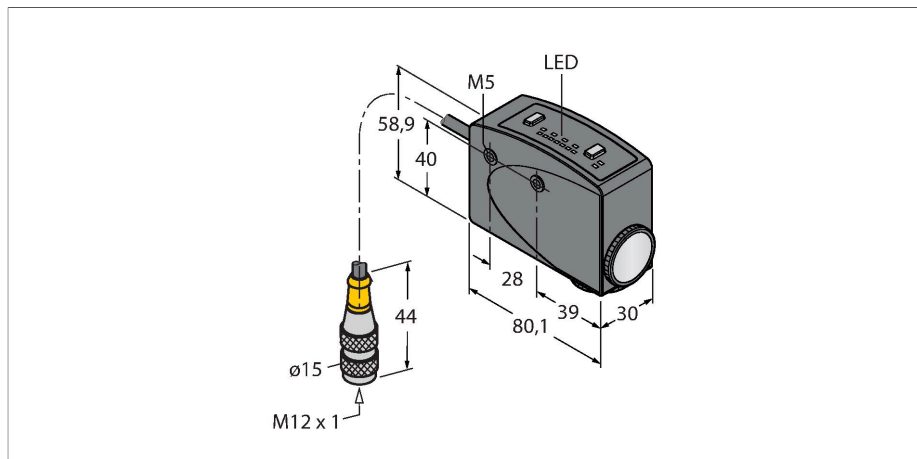

Features

- Cable with male end, PVC, 5-pin, 2 m
- Protection class IP67
- Programmed via 2 teach buttons
- Detects extremely small differences in contrast
- Adjustable on/off delay, 30 ms
- Automatic selection of red, green and blue light
- Parallel scan field relative to the housing axis
- Optics rotatable by 90°
- Operating voltage: 10...30 VDC
- PNP switching output
- Switching behavior adjustable (NO/NC)
- Teach input

Technical data

Type	R58BPCRGB1Q
ID	3015648
Optical data	
Function	Inspection sensor
Operating mode	Contrast sensor
Light type	RGB
Focal distance	10 mm
Range	10 mm
Electrical data	
Operating voltage	10...30 VDC
Residual ripple	< 10 % U _{ss}
DC rated operational current	≤ 100 mA
No-load current	≤ 75 mA
Short-circuit protection	yes
Reverse polarity protection	yes
Output function	NO contact, PNP
Switching frequency	10 kHz
Readiness delay	≤ 1000 ms
Setting option	Push Button Remote Teach
Mechanical data	
Design	Rectangular, R58
Dimensions	80.1 x 30 x 58.9 mm
Housing material	Metal, Zinc Alloy Die-Cast, Black-finished
Lens	plastic, Acrylic

Wiring diagram

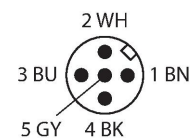
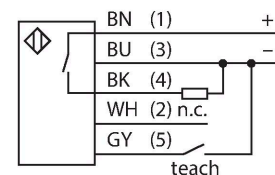

Functional principle

The color mark sensor differentiates between all conventional color contrasts occurring in product and material registration. From three differently colored LEDs, the device automatically selects the most appropriate one to achieve the highest contrast ratio. The very short response time of 50 μs is ideally suited for high speed applications. Adjustments such as contrast ratio, switch behaviour and time delay, can either be made directly via pushbuttons at the sensor or remotely via external teach line (gy). Furthermore, the device can be taught to differentiate between ON and OFF state, either statically before commissioning or dynamically during operation.

Technical data

Electrical connection	Cable with connector, M12 × 1, 0.15 m, PVC
Number of cores	4
Ambient temperature	-10...+55 °C
Relative humidity	0...90 %
Protection class	IP67
Special features	keep/defer
Power-on indication	LED, Green
Switching state	LED, Yellow
Excess gain indication	LED, red
Tests/approvals	
Approvals	CE

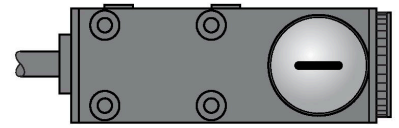

Accessories

SMB55A

3053259

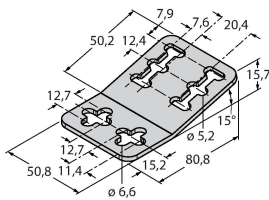

Mounting bracket, stainless steel, for R58A/R58E and QL56/QL51

SMB55RA

3053261

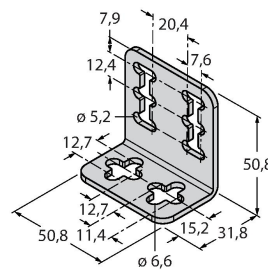

Mounting bracket, rectangular, stainless steel, for R58A/R58E and QL56/QL51

SMB55F

3053260

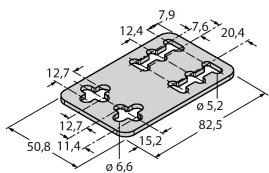

Mounting panel, stainless steel, for R58A/R58E and QL56/QL51

SMB55S

3053265

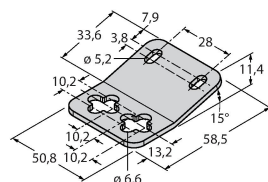

Mounting bracket, stainless steel, for R58A/R58E and QL56/QL51

Accessories

Dimension drawing	Type	ID	
	WKC4.5T-2/TEL	6625028	Connection cable, female M12, angled, 5-pin, cable length: 2 m, sheath material: PVC, black; cULus approval; other cable lengths and qualities available, see www.turck.com

Dimension drawing	Type	ID	
	RKC4.5T-2/TEL	6625016	Connection cable, female M12, straight, 5-pin, cable length: 2 m, sheath material: PVC, black; cULus approval; other cable lengths and qualities available, see www.turck.com

