

Passive GaAs MMIC 26.5 GHz Equalizer

MEQ10-26AS

LEAD-FREE / RoHS-COMPLIANT

1 Device Overview

1.1 General Description

The MEQ10-26AS passive MMIC equalizer is an ideal solution for compensating for low pass filtering effects in RF/microwave and high speed digital systems. This equalizer provides positive slope from DC to 26.5 GHz with a DC attenuation value of 10dB and a 50-ohm match maintained over the entire operating range. GaAs MMIC technology provides consistent unit-to-unit performance in a small, low cost form factor. Contact the factory for connectorized versions of our other MEQ products.



Module

1.2 Features

- DC attenuation of 10dB
- Typical Insertion Loss 0.7 dB at 26.5 GHz
- Return loss: typical 20 dB over the entire band
- [S2P data](#)
- Bidirectional

1.3 Applications

- RF Transceivers
- High-Speed Data
- Telecom
- Cable Loss Compensation
- Amplifier Compensation

1.4 Functional Block Diagram



1.5 Part Ordering Options¹

Part Number	Description	Package	Green Status	Product Lifecycle	Export Classification
MEQ6-26AS	Connectorized Module SMA-F/M	S	RoHS	Active	EAR99

¹ Refer to our [website](#) for a list of definitions for terminology presented in this table.

Table of Contents

1	Device Overview	1	2.2	Port Functions	3
1.1	General Description	1	3	Specifications	4
1.2	Features	1	3.1	Absolute Maximum Ratings.....	4
1.3	Applications	1	3.2	Package Information.....	4
1.4	Functional Block Diagram	1	3.3	Electrical Specifications	4
1.5	Part Ordering Options.....	1	3.4	Typical Performance Plots	5
2	Port Configurations and Functions	3	3.4.1	Insertion Loss	5
2.1	Port Diagram	3	3.4.2	Return loss & Group delay	5
			4	Mechanical Data.....	6
			4.1	S Package Outline Drawing.....	6

Revision History

Revision Code	Revision Date	Comment
-	August 2019	Datasheet Initial Release



2 Port Configurations and Functions

2.1 Port Diagram

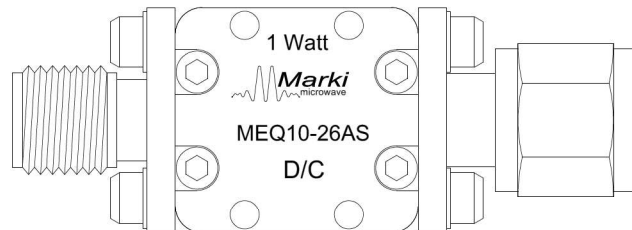
A top-down view of the MEQ10-26AS package outline drawing is shown below.

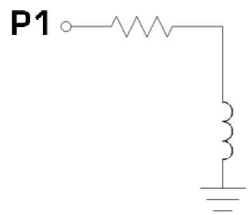
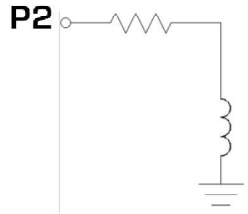

2.2 Port Functions

Port	Function	Description	Equivalent Circuit
Port 1	Input/Output	Port 1 is DC connected to ground through a resistor. DC block is required if voltage present.	
Port 2	Input/Output	Port 2 is DC connected to ground through a resistor. DC block is required if voltage present.	
Pad	Ground	S package ground provided through metal housing and outer coax conductor.	

3 Specifications

3.1 Absolute Maximum Ratings

The Absolute Maximum Ratings indicate limits beyond which damage may occur to the device. If these limits are exceeded, the device may be inoperable or have a reduced lifetime.

Parameter	Maximum Rating	Units
Port 1 DC Current	40	mA
Port 2 DC Current	40	mA
Power Handling, at any Port	+30	dBm
Operating Temperature	-55 to +100	°C
Storage Temperature	-65 to +125	°C

3.2 Package Information

Parameter	Details	Rating
ESD	Human Body Model (HBM), per MIL-STD-750, Method 1020	1A
Weight	S package	11.5 g

3.3 Electrical Specifications

The electrical specifications apply at $T_A=+25^{\circ}\text{C}$ in a 50Ω system. Typical data shown is for the equalizer in a S package with a sine wave input applied to port 1.

Min and Max limits are guaranteed at $T_A=+25^{\circ}\text{C}$.

Parameter	Frequency (GHz)	Min	Typ.	Max
Insertion Loss (dB)	0.01		10	
	10		3	
	18		1.2	
	26.5		0.7	1.5
Return Loss (dB)	DC-26.5	16	20	
Impedance (Ω)			50	

3.4 Typical Performance Plots

3.4.1 Insertion Loss

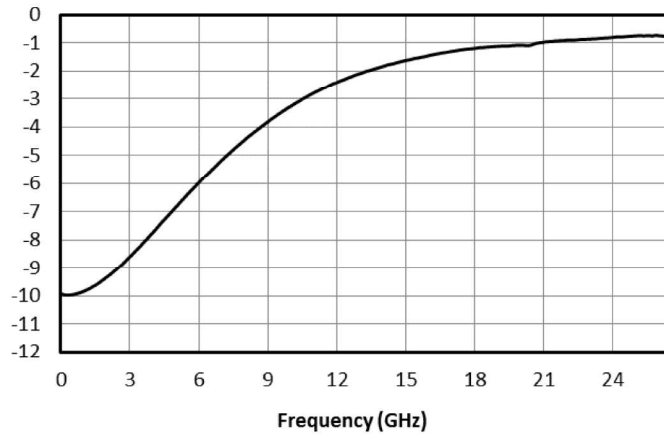

3.4.2 Return loss & Group delay

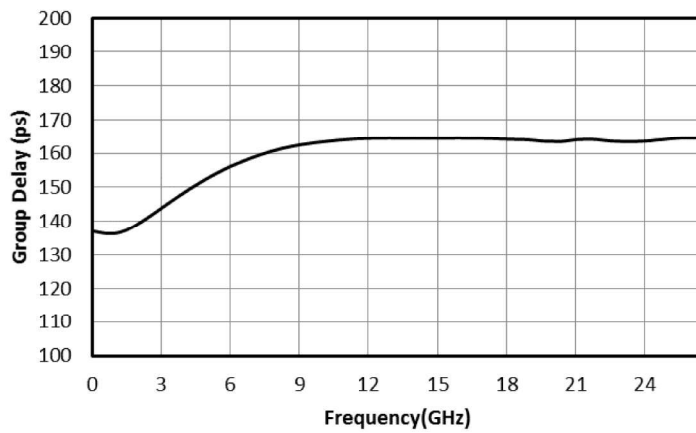
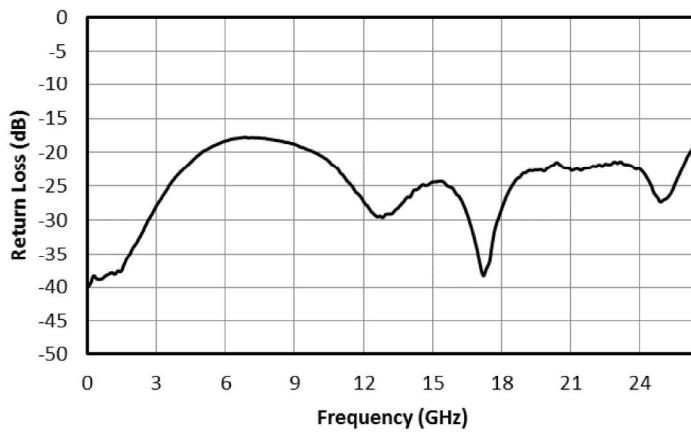

4 Mechanical Data

4.1 S Package Outline Drawing

Port	Connector Type
1	SMA Female
2	SMA Male

Note: S-Package Connectors are not removeable.

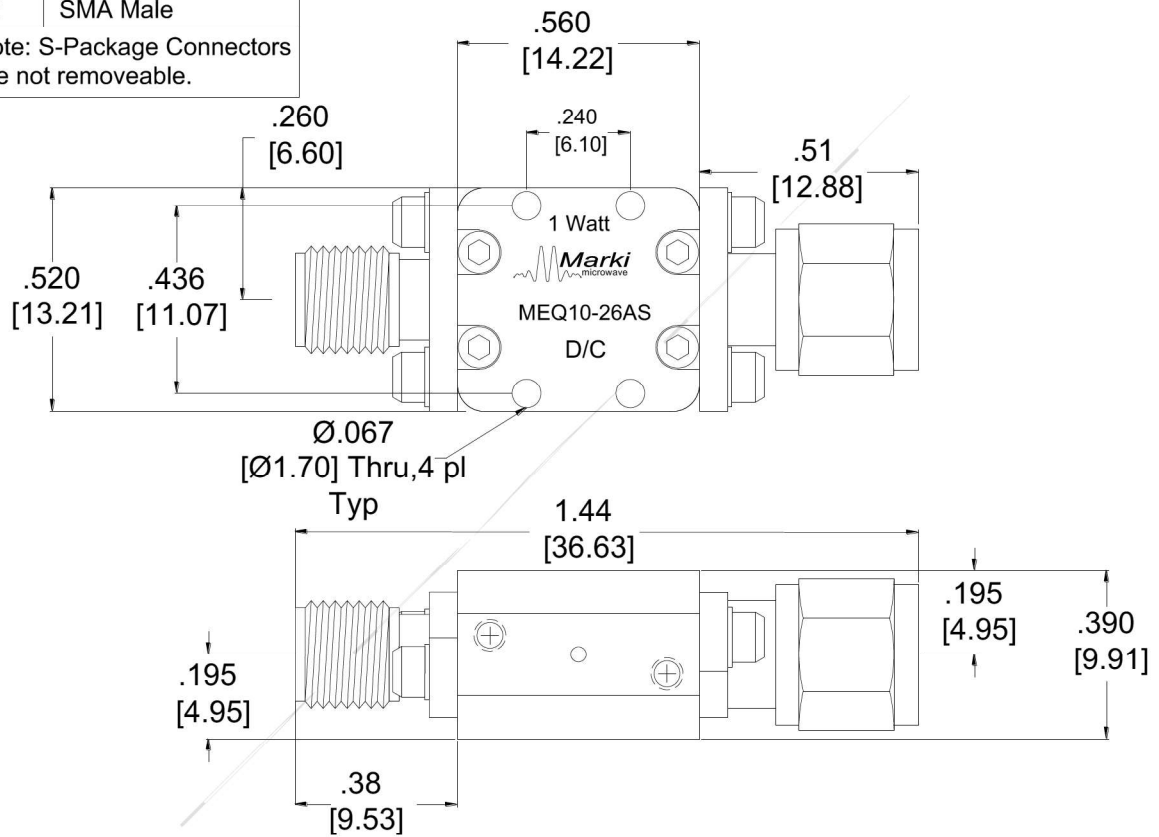
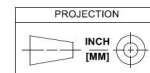

Marki Microwave reserves the right to make changes to the product(s) or information contained herein without notice.

Marki Microwave makes no warranty, representation, or guarantee regarding the suitability of its products for any particular purpose, nor does Marki Microwave assume any liability whatsoever arising out of the use or application of any product.