

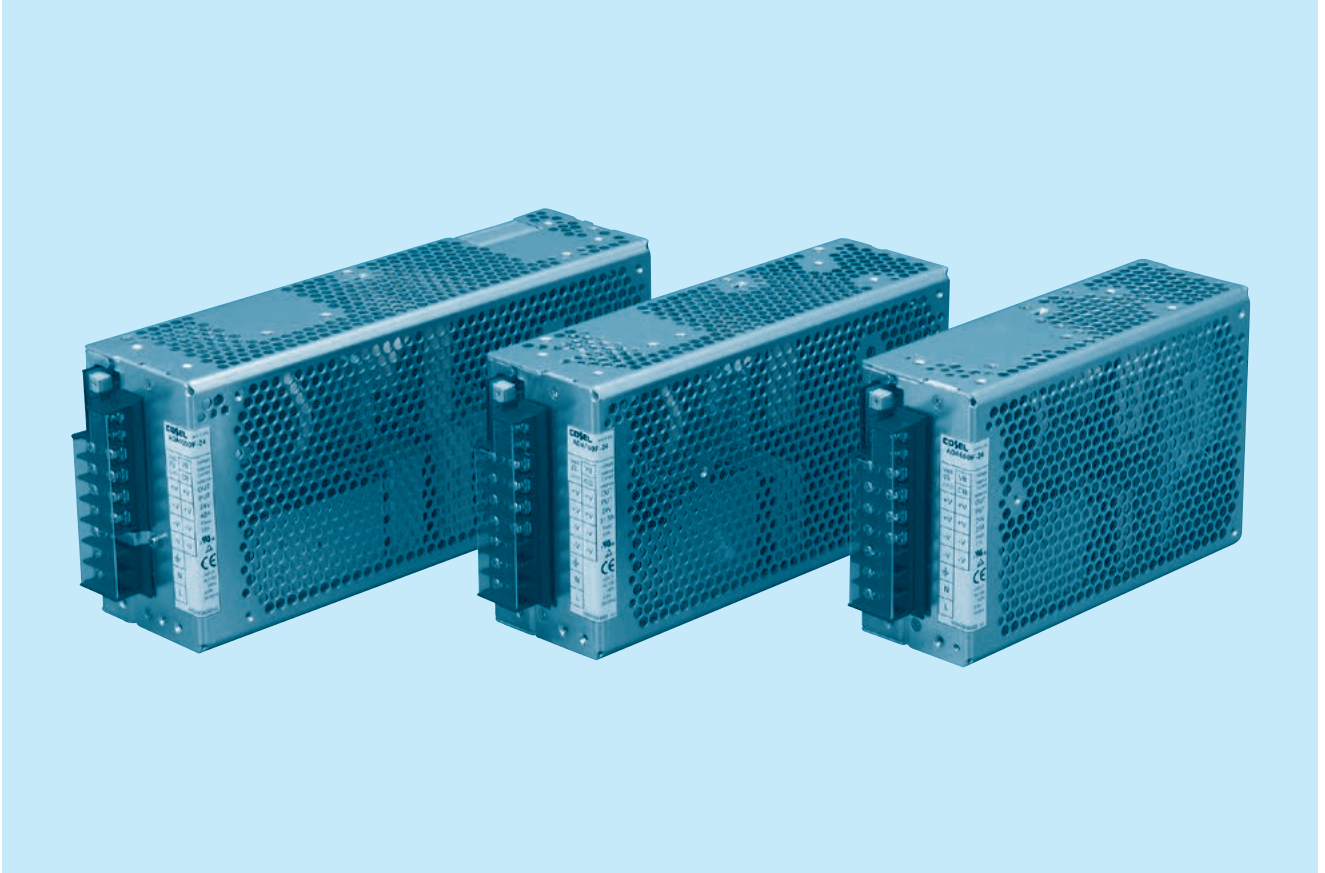

ADA-series



Feature

- High power & peak power
- Power up with fan (optional)
- Parallel operation / master-slave operation / N+1 redundant (optional)
- Harmonic attenuator (Complies with IEC61000-3-2)
- Universal input voltage (AC85 - 264V)
- Optional : remote ON/OFF, alarms
- Current monitor
- DIN rail (35mm) optional

Safety agency approvals

- UL60950-1, C-UL(CSA60950-1), EN62368-1
- Complies with DEN-AN

EMI

- Complies with FCC-B, CISPR22-B, EN55022-B, VCCI-B

5-year warranty (refer to Instruction Manual)

Optional parts

- Harness
- Fan unit
- Attachment

CE marking

- Low Voltage Directive
- RoHS Directive

EMS Compliance : EN61204-3, EN61000-6-2

- EN55022-B
- EN61000-3-2
- EN61000-4-2
- EN61000-4-3
- EN61000-4-4
- EN61000-4-5
- EN61000-4-6
- EN61000-4-8
- EN61000-4-11

ADA600F

① **ADA** ② **600** ③ **F** ④ **-24** ⑤ **-□**

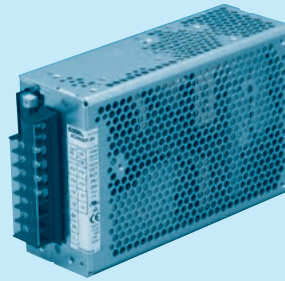

Example recommended EMI/EMC filter
NAC-20-472



High voltage pulse noise type : NAP series
Low leakage current type : NAM series
* A higher current rating EMI/EMC filter may be recommended in view of the other devices that could be connected in parallel with the power supply.

- ① Series name
 - ② Output wattage
 - ③ Universal input
 - ④ Output voltage
 - ⑤ Optional *7
 - G : Low leakage current
 - E : Low leakage current and EMI class A
 - F : with Fan unit
 - T : Vertical terminal block
 - J : Connector type
 - C : with Coating
 - R : Remote ON/OFF
 - N1: DIN rail
 - W: Alarms and Redundant operation
- Specification is changed at option, refer to Instruction Manual.

Please refer to derating curve, because the rated load current depends on cooling method that is convection cooling or forced air.

* Make sure necessary tests will be carried out on your end equipment with the power supply installed in accordance with any required EMC/EMI regulations.

SPECIFICATIONS

	MODEL	ADA600F-24	ADA600F-30	ADA600F-36	ADA600F-48	
INPUT	VOLTAGE[V]	AC85 - 264 1 φ or DC 120 - 350 (AC64 or DC90 optionally available *6)				
	FREQUENCY[Hz]	50/60 (47 - 63) or DC				
	EFFICIENCY[%]	ACIN 100V	84typ (Io=100%)	86typ (Io=100%)	86typ (Io=100%)	86typ (Io=100%)
		ACIN 200V	86typ (Io=100%)	87typ (Io=100%)	87typ (Io=100%)	89typ (Io=100%)
	POWER FACTOR	ACIN 100V	0.99typ (Io=100%)			
		ACIN 200V	0.98typ (Io=100%)			
INRUSH CURRENT[A]	ACIN 100V *1	20typ (Io=100%) (More than 3sec.to re-start)				
	ACIN 200V *1	40typ (Io=100%) (More than 3sec.to re-start)				
LEAKAGE CURRENT[ma]		0.75max (60Hz, According to IEC62368-1 and DEN-AN) (Io=100%)				
OUTPUT	VOLTAGE[V]	24	30	36	48	
	CURRENT[A]	ACIN 100V *2	14 (Peak 25) convection	11 (Peak 20) convection	9 (Peak 16.5) convection	6.5 (Peak 12.5) convection
		ACIN 100V *2	21 (Peak 25) forced air	16.5 (Peak 20) forced air	14 (Peak 16.5) forced air	10.5 (Peak 12.5) forced air
		ACIN 200V *2	15 (Peak 31) convection	12 (Peak 24.5) convection	10 (Peak 20.5) convection	7 (Peak 15.5) convection
		ACIN 200V *2	25 (Peak 31) forced air	20 (Peak 24.5) forced air	16.5 (Peak 20.5) forced air	12.5 (Peak 15.5) forced air
LINE REGULATION[mV]	96max	120max	144max	192max		
LOAD REGULATION[mV]	150max	180max	240max	300max		
RIPPLE[mVp-p]	0 to +50°C *3	120max	160max	200max	200max	
	-10 - 0°C *3	160max	230max	260max	300max	
RIPPLE NOISE[mVp-p]	0 to +50°C *3	150max	190max	230max	250max	
	-10 - 0°C *3	180max	250max	280max	400max	
TEMPERATURE REGULATION[mV]	0 to +50°C	240max	300max	360max	480max	
DRIFT[mV]	*4	96max	120max	144max	192max	
START-UP TIME[ms]		500max (ACIN 100V, Io=100%)				
HOLD-UP TIME[ms]		20typ (ACIN 100V, Io=100%)				
OUTPUT VOLTAGE ADJUSTMENT RANGE[V]		21.6 - 27.0	27.0 - 33.0	33.0 - 41.0	41.0 - 52.8	
OUTPUT VOLTAGE SETTING[V]		23.5 - 24.5	29.0 - 31.0	35.0 - 37.0	47.0 - 49.0	
PROTECTION CIRCUIT AND OTHERS	OVERCURRENT PROTECTION	Works over 101% of peak current and recovers automatically				
	OVERVOLTAGE PROTECTION[V]	31 - 34.5	40 - 48	51 - 60	64 - 76	
	OPERATING INDICATION	LED (Green)				
	ALARM OUTPUT	Detecting low input voltage(PF), detecting low output voltage(LV). (Optional : -W, refer to Instruction Manual 6)				
	REMOTE ON/OFF(RC)	Requirement for external source (Option : -R, refer to Instruction Manual 6)				
ISOLATION	INPUT-OUTPUT · RC	*5 AC3,000V 1minute. Cutoff current = 10mA, DC500V 50MΩ min (At Room Temperature)				
	INPUT-FG	AC2,000V 1minute. Cutoff current = 10mA, DC500V 50MΩ min (At Room Temperature)				
	OUTPUT · RC-FG	*5 AC500V 1minute. Cutoff current = 100mA, DC500V 50MΩ min (At Room Temperature)				
ENVIRONMENT	OPERATING TEMP., HUMID. AND ALTITUDE	-10 to +71°C, 20 - 90%RH (Non condensing) (Refer to "Derating"), 3,000m (10,000feet) max				
	STORAGE TEMP., HUMID. AND ALTITUDE	-20 to +75°C, 20 - 90%RH (Non condensing), 9,000m (30,000feet) max				
	VIBRATION	10 - 55Hz, 19.6m/s ² (2G), 3minutes period, 60minutes each along X, Y and Z axis				
	IMPACT	196.1m/s ² (20G), 11ms, once each X, Y and Z axis				
SAFETY AND NOISE REGULATIONS	AGENCY APPROVALS	UL60950-1, C-UL(CSA60950-1), EN62368-1 Complies with DEN-AN				
	CONDUCTED NOISE	Complies with FCC-B, CISPR22-B, EN55022-B, VCCI-B				
	HARMONIC ATTENUATOR	Complies with IEC61000-3-2 *8				
OTHERS	CASE SIZE/WEIGHT	65 x 127 x 195mm [2.56 x 5 x 7.68 inches] (W x H x D) (without terminal block) /1.5kg max				
	COOLING METHOD	Convection/Forced air				

*1 The value is primary surge. The current of input surge to a built-in EMI/EMC Filter (0.2ms or less) is excluded.
*2 Peak loading for 10sec. And Duty 35% max. Refer to Instruction Manual 4. Forced air is shown in "Derating".
*3 This is the value that measured on measuring board with capacitor of 22 μF within 150mm from output terminal. Measured by 20MHz oscilloscope or Ripple-Noise meter (Equivalent to KEISOKU-GIKEN: RM101).

*4 Drift is the change in DC output for an eight hour period after a half-hour warm-up at 25°C, with the input voltage held constant at the rated input/output.
*5 Applicable when remote control (optional) is added.
*6 Derating is required. Consult us for details.
*7 Please contact us about safety approvals for the model with option.
*8 Please contact us about class C.
* A sound may occur from power supply at pulse loading.

Block diagram

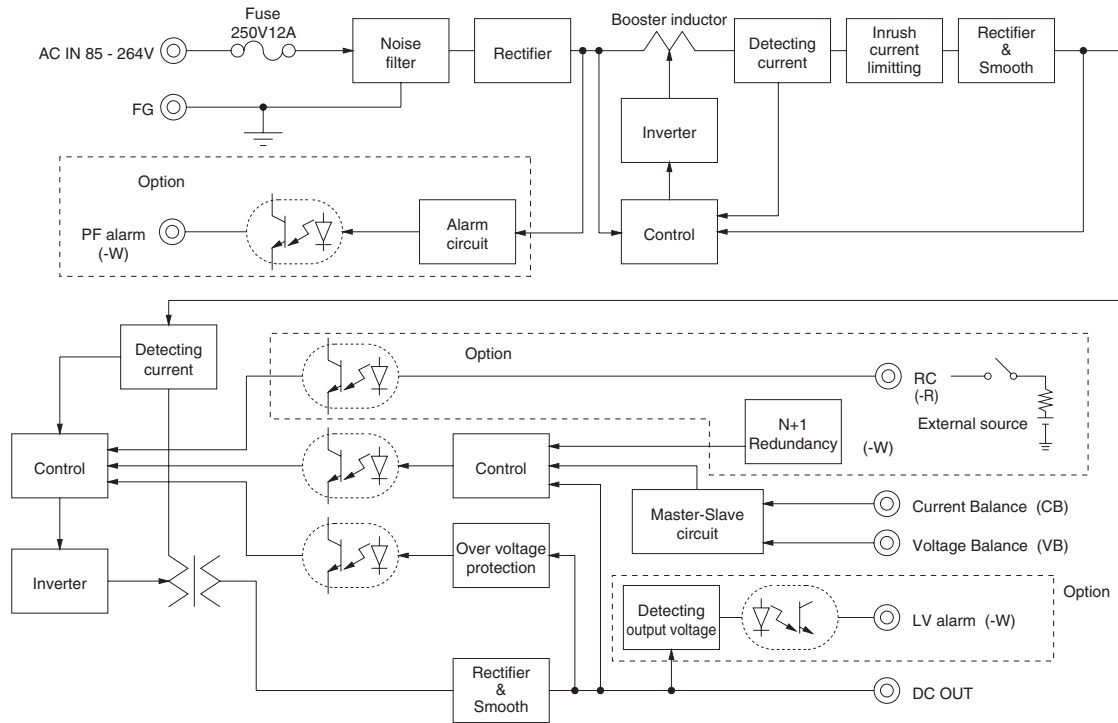

External view

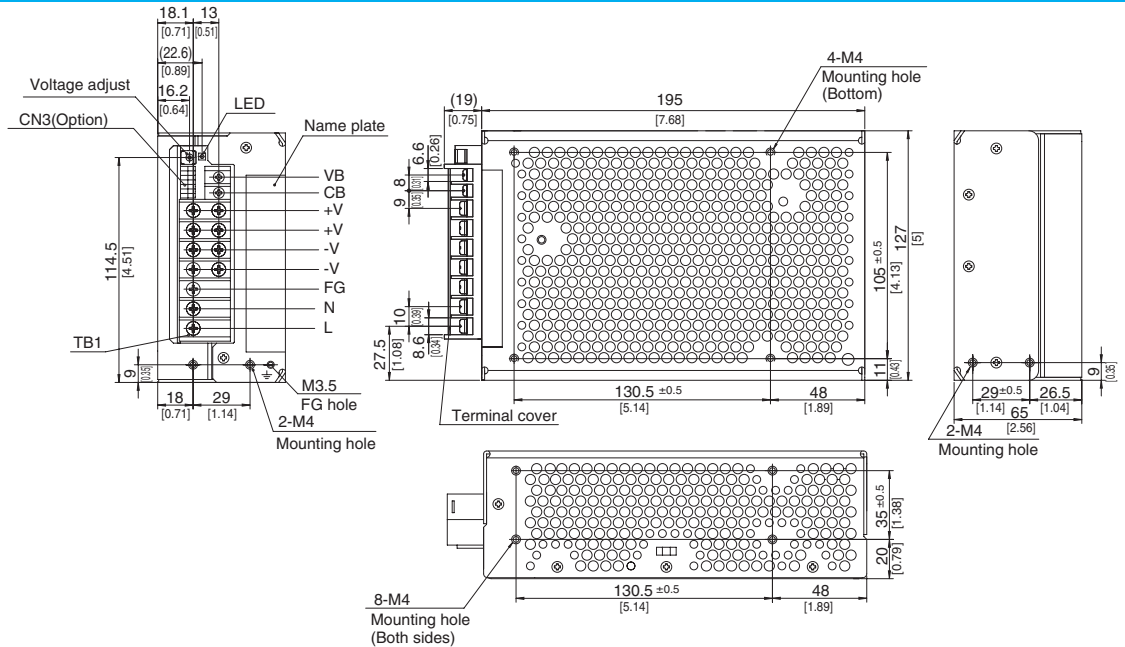

※ Pin assign

Symbol	Function	Screw type
VB	Voltage balance	M3
CB	Current balance	
+V	Output terminal(+)	M4
-V	Output terminal(-)	
+V	Output terminal(+)	
-V	Output terminal(-)	
FG	Frame ground	
N	AC(N)	
L	AC(L)	

Average 21A max per pin for TB1

CN3(Optional)

Pin No.	Function
1	RC+ : Remote ON/OFF+(+R)
2	RC- : Remote ON/OFF(-R)
3-8	NC : N.C.
9	LV+ : LV Alarm(-W)
10	LV- : LV Alarm ground(-W)
11-12	NC : N.C.
13	PF+ : PF Alarm(-W)
14	PF- : PF Alarm ground(-W)

Connector	Mating connector	Terminal	Mfr.
CN3	S14B-PHDS	Chain:SPHD-002T-P0.5 Loose:BPHD-001T-P0.5 BPHD-002T-P0.5	J.S.T

※ 1 Ratchet Hand is nothing

※ Tolerance : ±1 [=0.04]

※ Weight : 1.5kg max

※ PCB material / thickness : FR-4 / 1.6mm [0.06]

※ Chassis and cover material : aluminium

※ Dimensions in mm, [] = inches

※ Mounting torque : 1.2N · m(12.8kgf · cm) max

※ Screw tightening torque

M4 : 1.6N · m(16.3kgf · cm) max, M3 : 0.8N · m(8.5kgf · cm) max

※ I/O terminal for option-J and -T is shown in Instruction Manual 6.

ADA750F

① ADA ② 750 ③ F ④ -24 ⑤ -□

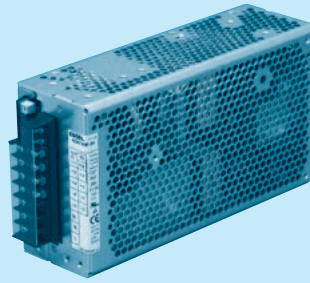

Example recommended EMI/EMC filter
NAC-20-472



High voltage pulse noise type : NAP series
Low leakage current type : NAM series
* A higher current rating EMI/EMC filter may be recommended in view of the other devices that could be connected in parallel with the power supply.

- ① Series name
 - ② Output wattage
 - ③ Universal input
 - ④ Output voltage
 - ⑤ Optional *7
 - G : Low leakage current
 - E : Low leakage current and EMI class A
 - F : with Fan unit
 - T : Vertical terminal block
 - J : Connector type
 - C : with Coating
 - R : Remote ON/OFF
 - N1: DIN rail
 - W: Alarms and Redundant operation
- Specification is changed at option, refer to Instruction Manual.

Please refer to derating curve, because the rated load current depends on cooling method that is convection cooling or forced air.

* Make sure necessary tests will be carried out on your end equipment with the power supply installed in accordance with any required EMC/EMI regulations.

SPECIFICATIONS

	MODEL	ADA750F-24	ADA750F-30	ADA750F-36	ADA750F-48	
INPUT	VOLTAGE[V]	AC85 - 264 1 φ or DC 120 - 350 (AC64 or DC90 optionally available *6)				
	FREQUENCY[Hz]	50/60 (47 - 63) or DC				
	EFFICIENCY[%]	ACIN 100V	86typ (Io=100%)	86typ (Io=100%)	87typ (Io=100%)	87typ (Io=100%)
		ACIN 200V	88typ (Io=100%)	88typ (Io=100%)	89typ (Io=100%)	89typ (Io=100%)
	POWER FACTOR	ACIN 100V	0.99typ (Io=100%)			
		ACIN 200V	0.98typ (Io=100%)			
INRUSH CURRENT[A]	ACIN 100V *1	20typ (Io=100%) (More than 3sec.to re-start)				
	ACIN 200V *1	40typ (Io=100%) (More than 3sec.to re-start)				
LEAKAGE CURRENT[ma]		0.75max (60Hz, According to IEC62368-1 and DEN-AN) (Io=100%)				
OUTPUT	VOLTAGE[V]	24	30	36	48	
	CURRENT[A]	ACIN 100V *2	17 (Peak 42) convection	13.5 (Peak 33.5) convection	11 (Peak 28) convection	8 (Peak 21) convection
		ACIN 100V *2	25 (Peak 42) forced air	20 (Peak 33.5) forced air	16.5 (Peak 28) forced air	12.5 (Peak 21) forced air
		ACIN 200V *2	19 (Peak 63) convection	15 (Peak 50) convection	12.5 (Peak 42) convection	9 (Peak 31.5) convection
		ACIN 200V *2	31.5 (Peak 63) forced air	24.5 (Peak 50) forced air	20.5 (Peak 42) forced air	15.5 (Peak 31.5) forced air
	LINE REGULATION[mV]	96max	120max	144max	192max	
LOAD REGULATION[mV]	150max	180max	240max	300max		
RIPPLE[mVp-p]	0 to +50°C *3	120max	160max	200max	200max	
	-10 - 0°C *3	160max	230max	260max	300max	
RIPPLE NOISE[mVp-p]	0 to +50°C *3	150max	190max	230max	250max	
	-10 - 0°C *3	180max	250max	280max	400max	
TEMPERATURE REGULATION[mV]	0 to +50°C	240max	300max	360max	480max	
DRIFT[mV]	*4	96max	120max	144max	192max	
START-UP TIME[ms]		500max (ACIN 100V, Io=100%)				
HOLD-UP TIME[ms]		20typ (ACIN 100V, Io=100%)				
OUTPUT VOLTAGE ADJUSTMENT RANGE[V]		21.6 - 27.0	27.0 - 33.0	33.0 - 41.0	41.0 - 52.8	
OUTPUT VOLTAGE SETTING[V]		23.5 - 24.5	29.0 - 31.0	35.0 - 37.0	47.0 - 49.0	
PROTECTION CIRCUIT AND OTHERS	OVERCURRENT PROTECTION	Works over 101% of peak current and recovers automatically				
	OVERVOLTAGE PROTECTION[V]	31 - 34.5	40 - 48	51 - 60	64 - 76	
	OPERATING INDICATION	LED (Green)				
	ALARM OUTPUT	Detecting low input voltage(PF), detecting low output voltage(LV). (Optional : -W, refer to Instruction Manual 6)				
	REMOTE ON/OFF(RC)	Requirement for external source (Option : -R, refer to Instruction Manual 6)				
ISOLATION	INPUT-OUTPUT · RC	*5 AC3,000V 1minute, Cutoff current = 10mA, DC500V 50MΩ min (At Room Temperature)				
	INPUT-FG	AC2,000V 1minute, Cutoff current = 10mA, DC500V 50MΩ min (At Room Temperature)				
	OUTPUT · RC-FG	*5 AC500V 1minute, Cutoff current = 100mA, DC500V 50MΩ min (At Room Temperature)				
ENVIRONMENT	OPERATING TEMP., HUMID. AND ALTITUDE	-10 to +71°C, 20 - 90%RH (Non condensing) (Refer to "Derating"), 3,000m (10,000feet) max				
	STORAGE TEMP., HUMID. AND ALTITUDE	-20 to +75°C, 20 - 90%RH (Non condensing), 9,000m (30,000feet) max				
	VIBRATION	10 - 55Hz, 19.6m/s ² (2G), 3minutes period, 60minutes each along X, Y and Z axis				
	IMPACT	196.1m/s ² (20G), 11ms, once each X, Y and Z axis				
SAFETY AND NOISE REGULATIONS	AGENCY APPROVALS	UL60950-1, C-UL(CSA60950-1), EN62368-1 Complies with DEN-AN				
	CONDUCTED NOISE	Complies with FCC-B, CISPR22-B, EN55022-B, VCCI-B				
	HARMONIC ATTENUATOR	Complies with IEC61000-3-2 *8				
OTHERS	CASE SIZE/WEIGHT	70 x 127 x 230mm [2.76 x 5 x 9.06 inches] (W x H x D) (without terminal block) /1.9kg max				
	COOLING METHOD	Convection/Forced air				

*1 The value is primary surge. The current of input surge to a built-in EMI/EMC Filter (0.2ms or less) is excluded.
*2 Peak loading for 10sec. And Duty 35% max. Refer to Instruction Manual 4. Forced air is shown in "Derating".
*3 This is the value that measured on measuring board with capacitor of 22 μF within 150mm from output terminal. Measured by 20MHz oscilloscope or Ripple-Noise meter (Equivalent to KEISOKU-GIKEN: RM101).

*4 Drift is the change in DC output for an eight hour period after a half-hour warm-up at 25°C, with the input voltage held constant at the rated input/output.
*5 Applicable when remote control (optional) is added.
*6 Derating is required. Consult us for details.
*7 Please contact us about safety approvals for the model with option.
*8 Please contact us about class C.
* A sound may occur from power supply at pulse loading.

Block diagram

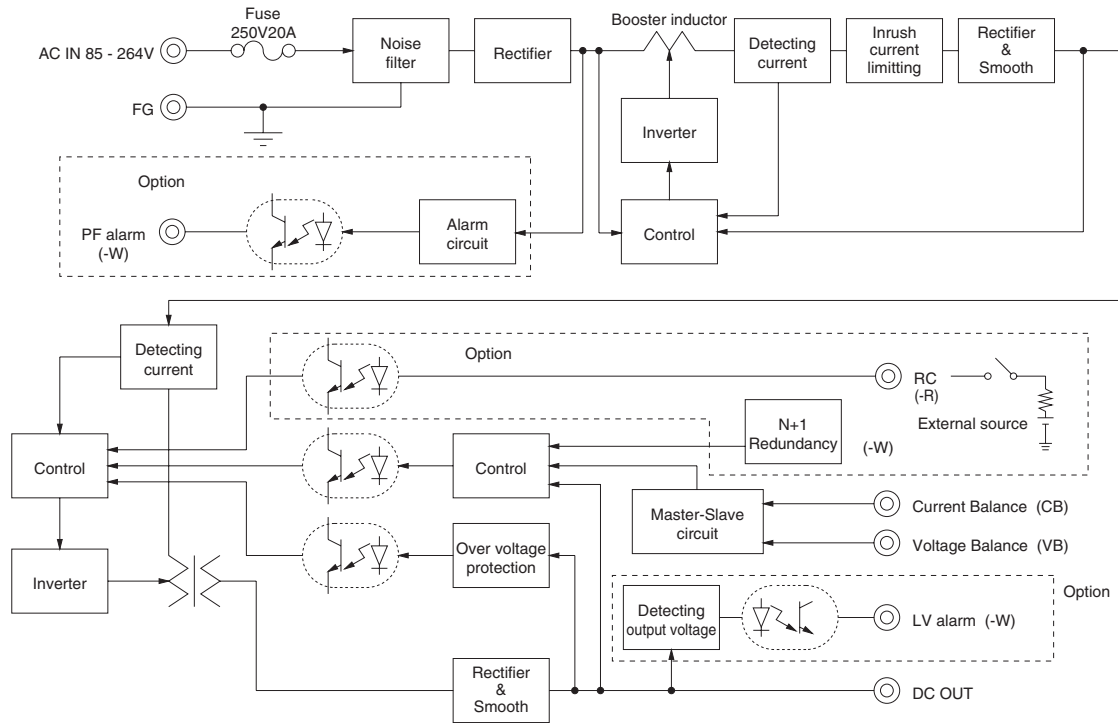

External view

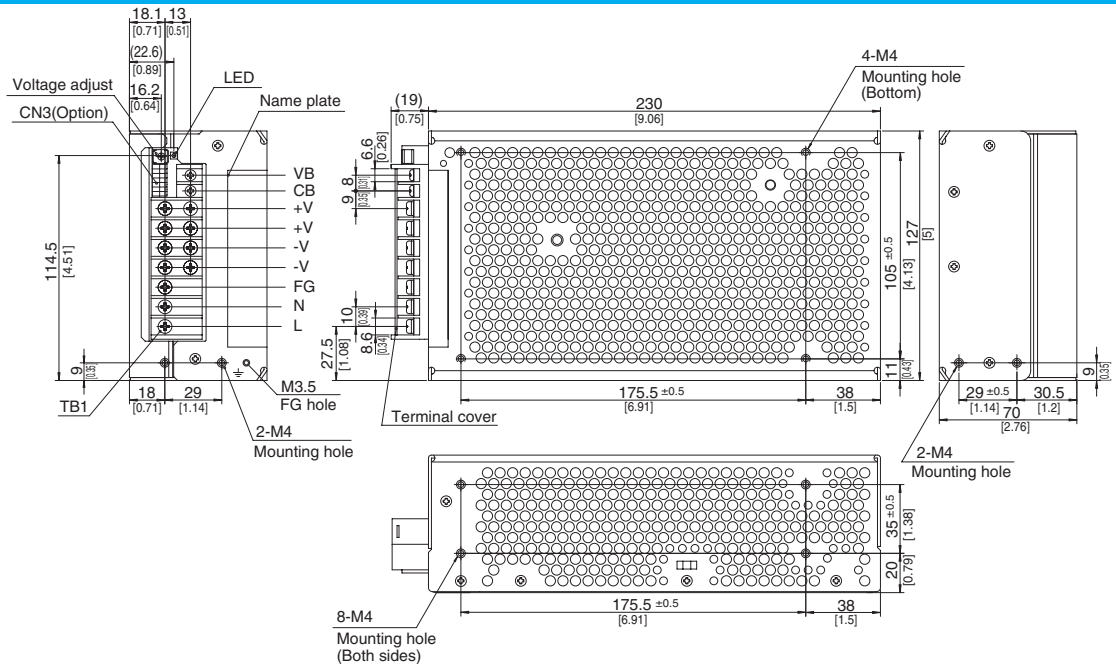

※ Pin assign

Symbol	Function	Screw type
VB	Voltage balance	M3
CB	Current balance	
+V	Output terminal(+)	M4
-V	Output terminal(+)	
-V	Output terminal(-)	
-V	Output terminal(-)	
FG	Frame ground	
N	AC(N)	
L	AC(L)	

Average 21A max per pin for TB1

- ※ Tolerance : ±1 [±0.04]
- ※ Weight : 1.9kg max
- ※ PCB material / thickness : FR-4 / 1.6mm [0.06]
- ※ Chassis and cover material : aluminium
- ※ Dimensions in mm, [] = inches
- ※ Mounting torque : 1.2N • m (12.8kgf • cm) max
- ※ Screw tightening torque

M4 : 1.6N • m (16.9kgf • cm) max, M3 : 0.8N • m (8.5kgf • cm) max
 ※ I/O terminal for option-J and -T is shown in Instruction Manual 6.

CN3(Optional)

Pin No.	Function
1	RC+ : Remote ON/OFF+(-R)
2	RC- : Remote ON/OFF(-R)
3-8	NC : N.C.
9	LV+ : LV Alarm(-W)
10	LV- : LV Alarm ground(-W)
11-12	NC : N.C.
13	PF+ : PF Alarm(-W)
14	PF- : PF Alarm ground(-W)

Connector	Mating connector	Terminal	Mfr.
CN3	S14B-PHDS5	PHDR-14VS	Chain:SPHD-002T-P0.5
			Loose:BPHD-001T-P0.5 BPHD-002T-P0.5 **

※ 1 Ratchet Hand is nothing

ADA1000F

① ADA 1000 ② F ③ -24 ④ - ⑤ □

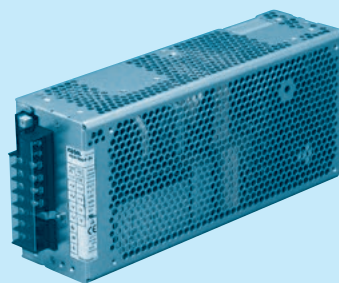

Example recommended EMI/EMC filter
NAC-20-472



High voltage pulse noise type : NAP series
Low leakage current type : NAM series
* A higher current rating EMI/EMC filter may be recommended in view of the other devices that could be connected in parallel with the power supply.

- ① Series name
 - ② Output wattage
 - ③ Universal input
 - ④ Output voltage
 - ⑤ Optional *7
 - G : Low leakage current
 - E : Low leakage current and EMI class A
 - F : with Fan unit
 - T : Vertical terminal block
 - J : Connector type
 - C : with Coating
 - R : Remote ON/OFF
 - N1: DIN rail
 - W: Alarms and Redundant operation
- Specification is changed at option, refer to Instruction Manual.

Please refer to derating curve, because the rated load current depends on cooling method that is convection cooling or forced air.
* Make sure necessary tests will be carried out on your end equipment with the power supply installed in accordance with any required EMC/EMI regulations.

SPECIFICATIONS

	MODEL	ADA1000F-24	ADA1000F-30	ADA1000F-36	ADA1000F-48	
INPUT	VOLTAGE[V]	AC85 - 264 1 φ or DC 120 - 350 (AC64 or DC90 optionally available *6)				
	FREQUENCY[Hz]	50/60 (47 - 63) or DC				
	EFFICIENCY[%]	ACIN 100V	86typ (Io=100%)	86typ (Io=100%)	87typ (Io=100%)	87typ (Io=100%)
		ACIN 200V	88typ (Io=100%)	88typ (Io=100%)	89typ (Io=100%)	89typ (Io=100%)
	POWER FACTOR	ACIN 100V	0.99typ (Io=100%)			
		ACIN 200V	0.98typ (Io=100%)			
INRUSH CURRENT[A]	ACIN 100V *1	20typ (Io=100%) (More than 3sec.to re-start)				
	ACIN 200V *1	40typ (Io=100%) (More than 3sec.to re-start)				
LEAKAGE CURRENT[ma]		0.75max (60Hz, According to IEC62368-1 and DEN-AN) (Io=100%)				
OUTPUT	VOLTAGE[V]	24	30	36	48	
	CURRENT[A]	ACIN 100V *2	21 (Peak 63) convection	16.5 (Peak 50) convection	14 (Peak 42) convection	10.5 (Peak 31.5) convection
		ACIN 100V *2	33 (Peak 63) forced air	26 (Peak 50) forced air	22 (Peak 42) forced air	16.5 (Peak 31.5) forced air
		ACIN 200V *2	25 (Peak 83) convection	20 (Peak 66) convection	16.5 (Peak 55) convection	11.5 (Peak 41.5) convection
		ACIN 200V *2	42 (Peak 83) forced air	33.5 (Peak 66) forced air	28 (Peak 55) forced air	21 (Peak 41.5) forced air
LINE REGULATION[mV]	96max	120max	144max	192max		
LOAD REGULATION[mV]	150max	180max	240max	300max		
RIPPLE[mVp-p]	0 to +50°C *3	120max	160max	200max	200max	
	-10 - 0°C *3	160max	230max	260max	300max	
	0 to +50°C *3	150max	190max	230max	250max	
	-10 - 0°C *3	180max	250max	280max	400max	
TEMPERATURE REGULATION[mV]	0 to +50°C	240max	300max	360max	480max	
DRIFT[mV]	*4	96max	120max	144max	192max	
START-UP TIME[ms]		500max (ACIN 100V, Io=100%)				
HOLD-UP TIME[ms]		20typ (ACIN 100V, Io=100%)				
OUTPUT VOLTAGE ADJUSTMENT RANGE[V]		21.6 - 27.0	27.0 - 33.0	33.0 - 41.0	41.0 - 52.8	
OUTPUT VOLTAGE SETTING[V]		23.5 - 24.5	29.0 - 31.0	35.0 - 37.0	47 - 49	
PROTECTION CIRCUIT AND OTHERS	OVERCURRENT PROTECTION	Works over 101% of peak current and recovers automatically				
	OVERVOLTAGE PROTECTION[V]	31 - 34.5	40 - 48	51 - 60	64 - 76	
	OPERATING INDICATION	LED (Green)				
	ALARM OUTPUT	Detecting low input voltage(PF), detecting low output voltage(LV). (Optional : -W, refer to Instruction Manual 6)				
REMOTE ON/OFF(RC)	Requirement for external source (Option : -R, refer to Instruction Manual 6)					
ISOLATION	INPUT-OUTPUT · RC	*5	AC3,000V 1minute, Cutoff current = 10mA, DC500V 50MΩ min (At Room Temperature)			
	INPUT-FG		AC2,000V 1minute, Cutoff current = 10mA, DC500V 50MΩ min (At Room Temperature)			
	OUTPUT · RC-FG	*5	AC500V 1minute, Cutoff current = 100mA, DC500V 50MΩ min (At Room Temperature)			
ENVIRONMENT	OPERATING TEMP., HUMID. AND ALTITUDE	-10 to +71°C, 20 - 90%RH (Non condensing) (Refer to "Derating"), 3,000m (10,000feet) max				
	STORAGE TEMP., HUMID. AND ALTITUDE	-20 to +75°C, 20 - 90%RH (Non condensing), 9,000m (30,000feet) max				
	VIBRATION	10 - 55Hz, 19.6m/s ² (2G), 3minutes period, 60minutes each along X, Y and Z axis				
SAFETY AND NOISE REGULATIONS	IMPACT	196.1m/s ² (20G), 11ms, once each X, Y and Z axis				
	AGENCY APPROVALS	UL60950-1, C-UL(CSA60950-1), EN62368-1 Complies with DEN-AN				
	CONDUCTED NOISE	Complies with FCC-B, CISPR22-B, EN55022-B, VCCI-B				
OTHERS	HARMONIC ATTENUATOR	Complies with IEC61000-3-2 *8				
	CASE SIZE/WEIGHT	75 x 127 x 280mm [2.95 x 5 x 11.02 inches] (W x H x D) (without terminal block) /2.5kg max				
	COOLING METHOD	Convection/Forced air				

*1 The value is primary surge. The current of input surge to a built-in EMI/EMC Filter (0.2ms or less) is excluded.
*2 Peak loading for 10sec. And Duty 35% max. Refer to Instruction Manual 4. Forced air is shown in "Derating".
*3 This is the value that measured on measuring board with capacitor of 22 μF within 150mm from output terminal. Measured by 20MHz oscilloscope or Ripple-Noise meter (Equivalent to KEISOKU-GIKEN: RM101).

*4 Drift is the change in DC output for an eight hour period after a half-hour warm-up at 25°C, with the input voltage held constant at the rated input/output.
*5 Applicable when remote control (optional) is added.
*6 Derating is required. Consult us for details.
*7 Please contact us about safety approvals for the model with option.
*8 Please contact us about class C.
* A sound may occur from power supply at pulse loading.

Block diagram

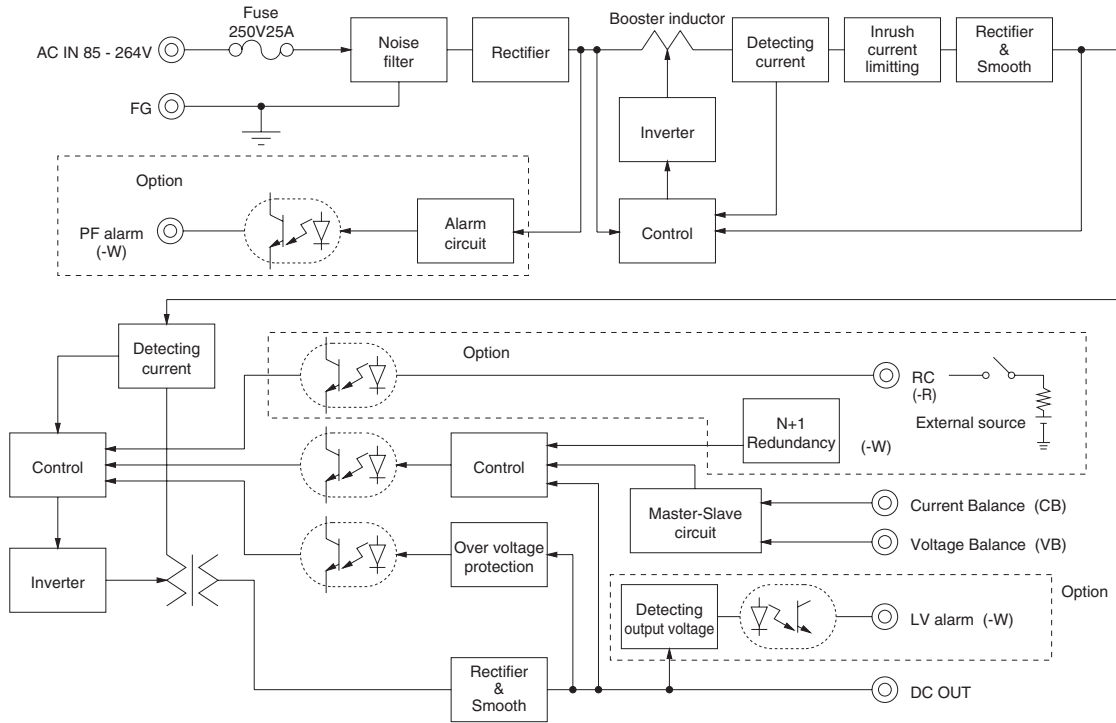

External view

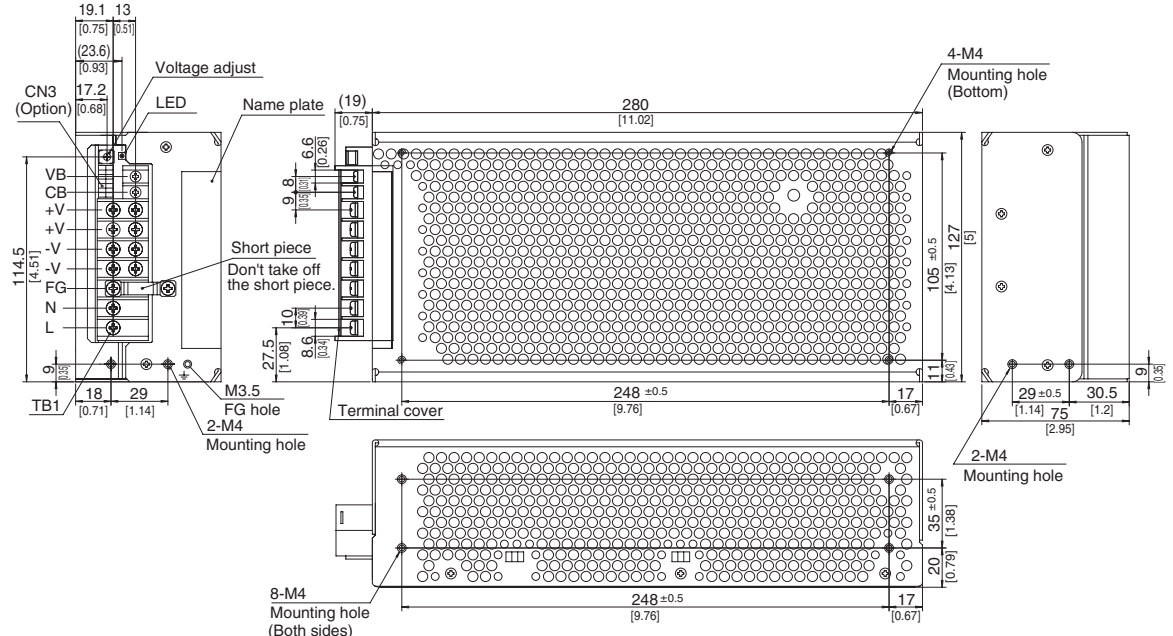

※ Pin assign

Symbol	Function	Screw type
VB	Voltage balance	M3
CB	Current balance	
+V	Output terminal(+)	M4
+V	Output terminal(+)	
-V	Output terminal(-)	
-V	Output terminal(-)	
FG	Frame ground	
N	AC(N)	
L	AC(L)	

Average 21A max per pin for TB1

- ※ Tolerance : ±1 [±0.04]
- ※ Weight : 2.5kg max
- ※ PCB material / thickness : FR-4 / 1.6mm [0.06]
- ※ Chassis and cover material : aluminium
- ※ Dimensions in mm, [] = inches
- ※ Mounting torque : 1.2N · m (12.8kgf · cm) max
- ※ Screw tightening torque
- ※ M4 : 1.6N · m (16.3kgf · cm) max, M3 : 0.8N · m (8.5kgf · cm) max
- ※ I/O terminal for option-J and -T is shown in Instruction Manual 6.

CN3(Optional)

Pin No.	Function
1	RC+ : Remote ON/OFF+(+R)
2	RC- : Remote ON/OFF(-R)
3-8	NC : N.C.
9	LV+ : LV Alarm(-W)
10	LV- : LV Alarm ground(-W)
11-12	NC : N.C.
13	PF+ : PF Alarm(-W)
14	PF- : PF Alarm ground(-W)

Connector	Mating connector	Terminal	Mfr.
CN3	S14B-PHDSS	Chain:SPHD-002T-P0.5 Loose:BPHD-001T-P0.5 BPHD-002T-P0.5*	J.S.T

* 1 Ratchet Hand is nothing

Assembling and Installation Method

Installation method

■ The screw should be inserted up to 6mm max from outside of the power supply to keep a distance between inside parts and an isolation.

■ When two or more power supplies are used side by side, position them with proper intervals to allow enough air ventilation. Ambient temperature around each power supply should not exceed the temperature range shown in “derating”.

■ Fix firmly, considering weight, though it can be used by the installation method shown in right figure.

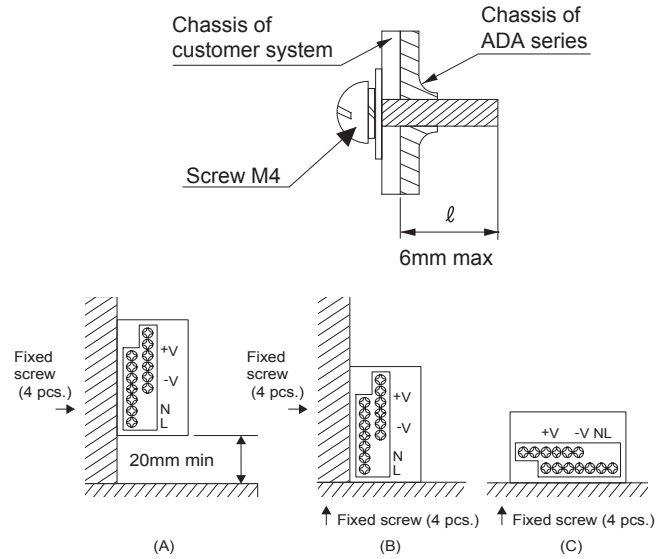

Derating

■ Derating by ambient temperature

Load factor 100% in each derating curve means rating current in Specifications. Please note load factor 100% depends on input voltage and cooling method. In the hatched area the specification of Ripple, Ripple Noise is different from other area.

■ Convection cooling

- ① Install the unit to apply enough convection as shown in “Installation method”.
- ② Do not block the ventilation hole.

● ADA600F Ambient temperature Derating Curve (convection cooling)

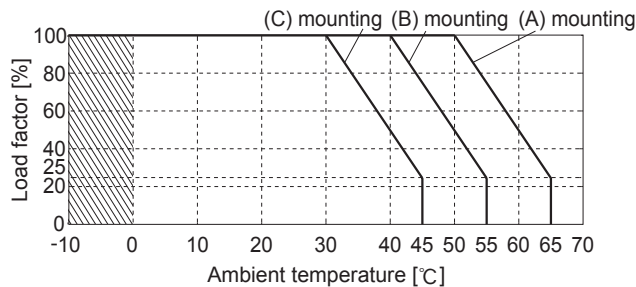

* In case of ADA600F-24, load factor 100% means output 24V, 14A at ACIN100V, 24V, 15A at ACIN200V.

● ADA750F Ambient temperature Derating Curve (convection cooling)

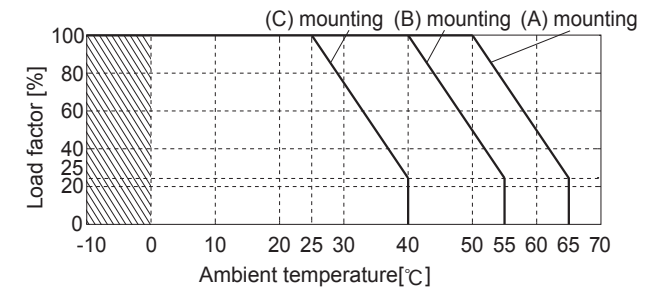

* In case of ADA750F-24, load factor 100% means output 24V, 17A at ACIN100V, 24V, 19A at ACIN200V.

● ADA1000F Ambient temperature Derating Curve (convection cooling)

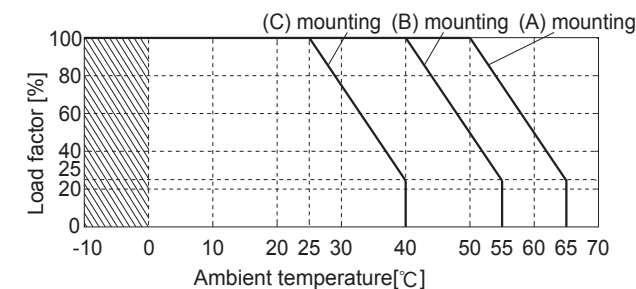

* In case of ADA1000F-24, load factor 100% means output 24V, 21A at ACIN100V, 24V, 25A at ACIN200V.

Derating

■ Forced air cooling

① Please give the entire power supply in ventilation so that the temperature of point A and B in right figure is made below a specified temperature. Point A and B are displayed in chassis.

- Point A 60C or less and point B 65C or less at Ta = 50C
- Point A 80C or less and point B 80C or less at Ta = 71C

Remarks : Please avoid cooling only bottom chassis.

- ② Ventilation is done evenly and do not block the ventilation hole.
- ③ The confirmation of point A and B in unnecessary when optional fun unit is used. Refer to instruction manual 6. Option.

*The derating curve at forced air is common in ADA600F to ADA1000F.

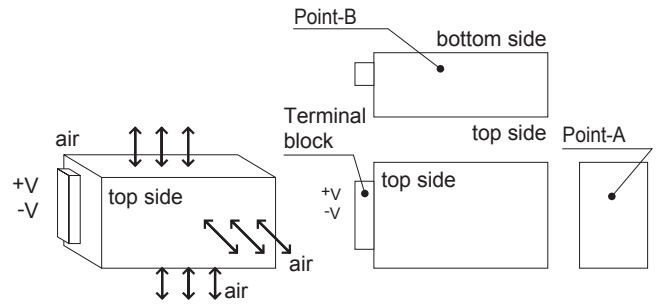

● AD600F-1000F Ambient temperature Derating Curve (forced air)

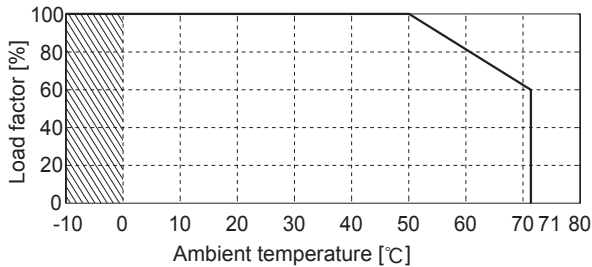

*In case of ADA600F-24, load factor 100% means output 24V, 21A at ACIN100V, 24V, 25A at ACIN200V.

*In case of ADA750F-24, load factor 100% means output 24V, 25A at ACIN100V, 24V, 31.5A at ACIN200V.

*In case of ADA1000F-24, load factor 100% means output 24V, 33A at ACIN100V, 24V, 42A at ACIN200V.

Instruction Manual

◆ It is necessary to read the “Instruction Manual” and “Before using our product” before you use our product.

Instruction Manual <https://en.cosel.co.jp/product/powersupply/ADA/>
 Before using our product <https://en.cosel.co.jp/technical/caution/index.html>



Basic Characteristics Data

Model	Circuit method	Switching frequency [kHz]	Input current [A]	Rated input fuse	Inrush current protection	PCB/Pattern			Series/Parallel operation availability	
						Material	Single sided	Double sided	Series operation	Parallel operation
ADA600F	Active filter	85	5.9 (Peak 7.0)	250V 12A	SCR	FR-4		Yes	Yes	Yes
	Forward converter	130								
ADA750F	Active filter	85	6.9 (Peak11.8)	250V 20A	SCR	FR-4		Yes	Yes	Yes
	Forward converter	130								
ADA1000F	Active filter	85	9.5 (Peak18.2)	250V 25A	SCR	FR-4		Yes	Yes	Yes
	Forward converter	130								

* Refer to Instruction Manual.
 * The value of input current is at ACIN 100V and rated load (peak).