



MIPI CSI-2 CAMERAS

# Alvium CSI-2 Cameras User Guide

V2.5.1

**Quick links**

- [Alvium CSI-2 cameras at a glance](#) on page 14
- [Contact us](#) on page 17
- [Contents](#) on page 18

# Read before use

## EN - English

### Safety

Before using the camera, read these safety instructions. Observe the warnings at all times. Use the camera only as stated in the [Intended use](#) on page 34.

**CAUTION****Risk of burns**

A camera in operation can reach temperature levels which could cause burns.

**CAUTION****Injury by falling cameras or lenses**

A falling camera or lens can cause injury.

**CAUTION****Risk of cuts by sharp edges of lens mounts**

The threads of the lens mount can have sharp edges.

### Intended use

Intended use of Allied Vision product is the integration into vision systems by professionals. All Allied Vision product is sold in a B2B setting.

### Cameras without closed housings

Cameras without housing or with incomplete housing must be shielded against EMC emission by professionals according to local EMC provisions.

## DA - Dansk

### Sikkerhed

Læs sikkerhedsanvisningerne, før kameraet bruges. Overhold alle advarsler. Brug kun kameraet som anført i [Intended use](#) på side 34.



#### FORSIGTIG

##### **Forbrændingsfare**

Når kameraet bruges, kan det blive meget varmt og forårsage forbrændinger.



#### FORSIGTIG

##### **Kvæstelser, hvis kameraet eller linser falder ned**

Falder kameraet eller linsen ned, kan dette forårsage kvæstelser.



#### FORSIGTIG

##### **Fare for snitsår på linsemodulets skarpe kanter**

Linsemodulets gevind kan have skarpe kanter.

### Tilsigtet brug

Allied Vision produktets tilsigtede brug er en indbygning i et visionssystem, udført af fagfolk. Alle Allied Vision produkter sælges i B2B.

### Kameraer uden lukket hus

Kameraer uden hus eller uden komplet hus skal beskyttes mod EMC emissioner iht. lokale EMC bestemmelser.

## DE - Deutsch

### Sicherheit

Bevor Sie die Kamera benutzen, lesen Sie diese Sicherheitshinweise. Beachten Sie diese Hinweise immer. Verwenden Sie die Kamera nur wie beschrieben in [Intended use](#) auf Seite 34.



#### VORSICHT

##### **Gefahr von Verbrennungen**

Im Betrieb kann die Kamera Temperaturen erreichen, die zu Verbrennungen führen.



#### VORSICHT

##### **Verletzung durch fallende Kameras oder Objektive**

Eine fallende Kamera oder ein fallendes Objektiv kann Verletzungen verursachen.



#### VORSICHT

##### **Schnitte durch scharfkantige Objektivgewinde**

Objektivgewinde können scharfe Kanten haben.

### Bestimmungsgemäßer Gebrauch

Allied Vision Produkte sind bestimmt für die Integration in Bildverarbeitungssysteme durch Fachpersonal. Alle Allied Vision Produkte werden in einer B2B-Umgebung verkauft.

### Kameras ohne geschlossenes Gehäuse

Für Kameras ohne Gehäuse oder mit unvollständigem Gehäuse muss die Abschirmung gegen EMV-Emissionen gemäß den örtlichen EMV-Bestimmungen durchgeführt werden.

## ES - Español

### Seguridad

Antes de utilizar la cámara lea estas instrucciones de seguridad. Observe las advertencias en todo momento. Utilice la cámara solo tal y como se estipula en el [Intended use](#) en la página 34.



#### ATENCIÓN

##### **Riesgo de quemaduras**

Una cámara en funcionamiento puede alcanzar temperaturas que podrían provocar quemaduras.



#### ATENCIÓN

##### **Lesiones en caso de que las cámaras o las lentes se caigan**

Si una cámara o una lente se cae puede provocar lesiones.



#### ATENCIÓN

##### **Riesgo de cortes debido a los bordes afilados del objetivo**

Las roscas de los objetivos pueden tener bordes afilados.

### Uso previsto

El uso previsto del producto Allied Vision es la integración en el sistema de visión por parte de profesionales. Todos los productos Allied Vision se venden dentro de una relación B2B.

### Cámaras sin carcasa cerrada

Las cámaras sin carcasa o con una carcasa incompleta deben protegerse contra las emisiones CEM por parte de profesionales de acuerdo con las disposiciones locales sobre la CEM.

## FI - Suomi

### Turvallisuus

Lue nämä turvallisuusohjeet ennen kameran käyttöä. Noudata varoituksia joka hetki. Käytä kameraa ainoastaan kohdassa [Intended use](#) sivulla 34 kuvatulla tavalla.



#### **HUOMIO**

##### **Palovammojen vaara**

Käytössä olevan kameran saavuttamat lämpötilatasot voivat aiheuttaa palovammoja.



#### **HUOMIO**

##### **Putoavien kameroiden tai linssien aiheuttamat vammat**

Putoava kamera tai linssi voi aiheuttaa vammoja.



#### **HUOMIO**

##### **Linssien kiinnikkeiden terävien reunojen aiheuttamien viiltovammojen vaara**

Linssin kiinnikkeiden kierteiden reunat voivat olla teräviä.

### Käyttötarkoitus

Allied Vision-tuotteen käyttötarkoitus on integrointi kuvajärjestelmiin ammattilaisten toimesta. Kaikki Allied Vision-tuotteet myydään B2B-ympäristössä.

### Kamerat, joissa ei ole suljettuja koteloita

Ammattilaisten on suojattava kamerat, joissa ei ole koteloa tai joiden kotelo on epätäydellinen, EMC-päästöiltä paikallisten EMC-määräysten mukaisesti.

## FR - Français

### Sécurité

Veillez lire ces consignes de sécurité avant d'utiliser la caméra. Respectez continuellement les avertissements. Utilisez la caméra uniquement comme indiqué sous [Intended use](#), page 34.



#### ATTENTION

##### Risque de brûlures

Une caméra en service peut atteindre des niveaux de température susceptibles d'entraîner des brûlures.



#### ATTENTION

##### Blessures en cas de chute de caméras ou d'objectifs

La chute d'une caméra ou d'un objectif peut entraîner des blessures.



#### ATTENTION

##### Risque de coupures sur les bords tranchants des montures d'objectif

Les filetages des montures d'objectif peuvent présenter des bords tranchants.

### Utilisation prévue

L'utilisation prévue du produit Allied Vision est son intégration dans des systèmes de vision par le soin de professionnels. Tout produit Allied Vision est vendu dans un cadre B2B.

### Caméras sans boîtier fermé

Les caméras sans boîtier fermé ou à boîtier incomplet doivent être blindées contre les émissions CEM par le soin de professionnels conformément aux dispositions CEM locales.

## IT - Italiano

### Sicurezza

Leggere queste istruzioni per la sicurezza prima di utilizzare la telecamera. Osservare sempre tutte le avvertenze. Utilizzare la telecamera come descritto alla sezione [Intended use](#) a pagina 34.



#### ATTENZIONE

##### **Pericolo di ustioni**

Durante il funzionamento una telecamera può raggiungere temperature elevate che possono essere causa di ustioni.



#### ATTENZIONE

##### **Lesioni dovute alla caduta di telecamere o lenti**

La caduta di una telecamera o di una lente può causare delle lesioni.



#### ATTENZIONE

##### **Pericolo di tagliarsi sui bordi affilati degli attacchi della lente**

I bordi della filettatura dell'attacco della lente possono essere affilati.

### Uso previsto

Il prodotto Allied Vision è concepito per essere integrato in sistemi di monitoraggio in campo professionale. Tutti i prodotti Allied Vision sono venduti in uno scenario B2B.

### Telecamere senza custodia chiusa

Le telecamere senza custodia o con una custodia incompleta devono essere protette dalle emissioni elettromagnetiche in ambienti professionali in conformità con le norme CEM nazionali.



## JA - 日本語

### 安全性

本カメラを使用する前に、この安全の手引きをお読みください。常に、警告事項を守ってください。必ず、[Intended use](#) 34 ページの通りに、本カメラを使用してください。



#### 注意

##### やけどの危険性

作動中のカメラは、やけどを引き起こす温度まで熱くなる恐れがあります。



#### 注意

##### カメラまたはレンズの落下によるけが

カメラまたはレンズが落下すると、けがをする恐れがあります。



#### 注意

##### レンズマウントの鋭利な端部で切り傷の危険性

レンズマウントのギザギザの部分が鋭利である可能性があります。

### 用途

Allied Vision製品は、専門家が視覚装置に統合することを意図したものです。すべてのAllied Vision製品は、企業間取り引き用に販売されています。

### ハウジングで閉じられていないカメラ

ハウジングのないカメラまたはハウジングが不完全なカメラは、現地の電磁両立性 (EMC) 規定に従い、専門家によって、EMCエミッションから保護される必要があります。

## NL - Nederlands

### Veiligheid

Lees deze veiligheidsinstructies voordat u de camera gaat gebruiken. Neem deze waarschuwingen altijd in acht. Gebruik de camera uitsluitend, zoals aangegeven in het [Intended use](#) op pagina 34.



#### VOORZICHTIG

##### Risico van verbranding

Een camera die gebruikt wordt, kan temperatuurwaarden bereiken die brandwonden kunnen veroorzaken.



#### VOORZICHTIG

##### Letsel door vallende camera's of lenzen

Een vallende camera of lens kan letsel veroorzaken.



#### VOORZICHTIG

##### Risico van snijwonden door scherpe randen van lensbevestigingen

Het schroefdraad van de lensbevestiging kan scherpe randen hebben.

### Beoogd gebruik

Het beoogde gebruik van het Allied Vision-product is de integratie in optische systemen door professionals. Alle Allied Vision-producten worden verkocht in de B2B-markt.

### Camera's zonder gesloten behuizing

Camera's zonder behuizing of met een onvolledige behuizing moeten door professionals worden beschermd tegen EMC-straling door EMC-beschermingen ter plaatse.

## NO - Norsk

### Sikkerhet

Les disse sikkerhetsinstruksene før du bruker kameraet. Følg advarslene til en hver tid. Bruk kun kameraet i samsvar med [Intended use](#) på side 34.



#### FORSIKTIG

##### Risiko for brannskader

Et kamera i bruk kan nå temperaturnivåer som kan forårsake brannskader.



#### FORSIKTIG

##### Skade ved fallende kameraer eller linser

Et fallende kamera eller en fallende linse kan forårsake skade.



#### FORSIKTIG

##### Risiko for kutt fra skarpe kanter på linsefester

Sporene på linsefestet kan ha skarpe kanter.

### Tiltenkt bruk

Den tiltenkte bruken av Allied Vision-produktet er integrering i visjonssystemer av profesjonelle. Alle Allied Vision-produkter selges i en forretning til forretning-situasjon.

### Kameraer uten lukkede kamerahus

Kameraer uten kamerahus eller med ufullstendige kamerahus må beskyttes mot EMC-utslipp av fagfolk i henhold til lokale EMC-bestemmelser.

## SV - Svenska

### Säkerhet

Läs igenom säkerhetsinstruktionerna innan du använder kameran. Var hela tiden särskilt uppmärksam på varningarna. Använd enbart kameran på det sätt som anges i [Intended use](#) på sida 34.



#### VARNING

##### Risk för brännskada

En kamera i drift kan komma upp i temperaturer som kan orsaka brännskador.



#### VARNING

##### Risk för skador från fallande kameror eller objektiv

Fallande kameror eller objektiv kan förorsaka skador.



#### VARNING

##### Risk för skärsår från vassa kanter på objektivfattningar

Objektivets gängor kan ha vassa kanter.

### Avsedd användning

Den avsedda användningen av Allied Vision-produkter är integrering i visionssystem av fackmän. Samtliga Allied Vision-produkter säljs i en B2B-miljö.

### Kameror utan slutna kamerahus

Kameror utan eller med ofullständiga kamerahus måste skyddas mot elektromagnetiska emissioner av fackmän enligt lokala bestämmelser för elektromagnetiska emissioner.

# ZH - 简体中文版

## 安全需知

使用本相机前，请阅读本安全说明书。请务必遵守相关警告和 [Intended use](#) 于第 34 页。



### 注意事项

#### 烫伤风险

相机操作过程中温度可能上升并导致烫伤风险。



### 注意事项

#### 相机或者镜头跌落造成伤害

相机或者镜头可能会跌落并造成伤害。



### 注意事项

#### 镜头接口的锐利边缘划伤风险

镜头接口螺纹边缘可能较为锐利。

## 预期用途

Allied Vision 产品的预期用途是由专业人士整合到视觉系统中。所有 Allied Vision 的产品均通过 B2B 渠道销售。

## 无封闭式外壳相机

使用不带外壳或外壳不完整的相机时，必须由专业人员根据当地的 EMC 规定，对其进行 EMC 屏蔽。

# Alvium CSI-2 cameras at a glance



Get an overview of Alvium CSI-2 camera documentation.

**Read this document carefully**

Learn to avoid damage to your Alvium CSI-2 camera and use it in the most safe and efficient way.

**NOTICE****Damage to camera and embedded hardware by improper handling**

Setup and operation for Alvium CSI-2 cameras in embedded systems is different than for cameras in PC-based systems. Components can easily be damaged.

- If you are unfamiliar with embedded systems, be extremely careful.
- Follow the safety notes.
- Follow the instructions in [Installing the hardware](#) on page 157.

**Achieved values for your system may not match specified values**

Values stated in [Specifications](#) on page 43 show the maximum available on an ideal system, supporting a bandwidth of 1.125 Gbps per lane. Your individual setup may affect available values such as for:

- Minimum and maximum exposure times and increments
- Maximum frame rates, including ROI frame rates
- Image resolution steps.

Please consider [Value changes by control interdependencies](#) on page 185 when you change settings.

**Individual properties of Alvium CSI-2 cameras**

Please consider individual properties of Alvium CSI-2 cameras to design applications successfully. See [Performance](#) on page 183 for details.

**Bare board cameras**

If you intend to design an application using bare board cameras, please consider:

- Aligning the sensor to the lens is extremely difficult and expensive. Therefore, we recommend you to do evaluation with housed cameras first.
- Bare board cameras are specialized components. We cannot give all data needed for any application in advance.
- Please let us partner with you for bare board camera applications to ensure a successful design.
- For reference, keep the **sandwich label including the serial numbers** of the Alvium chip and the camera itself with the camera. See [Serial numbers of Alvium® chips and bare board cameras](#) on page 159.

## Shipping contents

- Alvium CSI-2 camera
- Download Instructions for First Camera Operation document

## What else do you need?

This is a selection of helpful downloads:

Document	Link
Direct Register Access Controls Reference	<a href="http://www.alliedvision.com/en/support/technical-documentation/alvium-csi-2-documentation">www.alliedvision.com/en/support/technical-documentation/alvium-csi-2-documentation</a>
Alvium Cameras Hardware Options	
Alvium Cameras Accessory Guide	
Optimum Heat Dissipation for Housed Alvium Cameras application note	
Electromagnetic Compatibility for Open Housing Alvium Cameras application note	
Defect Pixel Correction on Alvium Cameras application note	
Avoiding Ground Loops in Vision Systems application note	
Sensor Alignment for Alvium Cameras white paper	

*Table 1: Document downloads for Alvium CSI-2 cameras*

Download or information	Link
Driver for Alvium CSI-2 cameras, code examples, and more	<a href="http://www.alliedvision.com/en/products/software/embedded-software-and-drivers">www.alliedvision.com/en/products/software/embedded-software-and-drivers</a>

*Table 2: Embedded software and driver downloads for Alvium CSI-2 cameras*



# Contact us

## Website, email

### General

[www.alliedvision.com/en/contact](http://www.alliedvision.com/en/contact)  
[info@alliedvision.com](mailto:info@alliedvision.com)

### Distribution partners

[www.alliedvision.com/en/avt-locations/avt-distributors](http://www.alliedvision.com/en/avt-locations/avt-distributors)

### Support

[www.alliedvision.com/en/support](http://www.alliedvision.com/en/support)  
[www.alliedvision.com/en/about-us/contact-us/technical-support-repair/-/rma](http://www.alliedvision.com/en/about-us/contact-us/technical-support-repair/-/rma)

## Offices

### Europe, Middle East, and Africa (Headquarters)

Allied Vision Technologies GmbH  
Taschenweg 2a  
07646 Stadtroda, Germany  
T// +49 36428 677-0 (Reception)  
T// +49 36428 677-230 (Sales)  
F// +49 36428 677-28

### Asia-Pacific

#### China

Allied Vision Technologies  
(Shanghai) Co., Ltd.  
2-2109 Hongwell Int. Plaza  
1602# ZhongShanXi Road  
Shanghai 200235, China  
T// +86 21 64861133

#### Singapore

Allied Vision Technologies Asia Pte. Ltd  
82 Playfair Rd, #07-02 D'Lithium  
Singapore 368001  
T// +65 6634 9027

### North, Central, and South America

#### Canada

Allied Vision Technologies Canada Inc.  
300 – 4621 Canada Way  
Burnaby, BC V5G 4X8, Canada  
T// +1 604 875 8855

#### USA

Allied Vision Technologies, Inc.  
102 Pickering Way- Suite 502  
Exton, PA 19341, USA  
Toll-free// +1-877-USA-1394  
T// +1 978 225 2030

# Contents

Read before use	2
EN - English	2
DA - Dansk	3
DE - Deutsch	4
ES - Español	5
FI - Suomi	6
FR - Français	7
IT - Italiano	8
JA - 日本語	9
NL - Nederlands	10
NO - Norsk	11
SV - Svenska	12
ZH - 简体中文版	13
Alvium CSI-2 cameras at a glance	14
Shipping contents	16
What else do you need?	16
Contact us	17
Document history and conventions	24
Document history	25
Conventions used in this user guide	28
Typographic styles	28
Symbols and notes	28
Naming and terms	29
Camera model naming	29
Terms and acronyms	30
Compliance, safety, and intended use	32
Compliance notifications	33
Bare board and open housing cameras	33
Avoid electromagnetic interferences	33
Intended use	34
Copyright and trademarks	34
Your safety	35
Handling lens mounts	35
Housed cameras: handling hot cameras	35
Providing optimum heat dissipation	35
Camera mounting	36
Heavy lenses	36
Product safety	37
Embedded systems	37
Supported embedded boards	37
Electrical connections	37

ESD.....	37
Cable connections .....	38
PCBAs.....	38
Camera power .....	38
Ground loops .....	38
FPC connectors.....	39
MIPI CSI-2 FPC cables.....	39
Handling bare board cameras .....	40
Optical components .....	41
Sensor .....	41
Lenses .....	42
Heat sinks and conductive media .....	42
Heat sinks .....	42
Conductive media for heat sinks.....	42
<b>Specifications</b> .....	<b>43</b>
Applied standards .....	44
MIPI CSI-2 .....	44
V4L2 .....	44
Shock and vibration .....	44
IEC 60068-2-6: Sinusoidal vibration .....	45
IEC 60068-2-27: Shock.....	45
IEC 60068-2-64: Random vibration.....	46
Notes on specifications.....	46
Sensor .....	46
Absolute QE plots.....	46
Spectral response plots.....	47
Resolution limitations.....	47
Pixel format default and naming.....	47
Exposure time, bandwidth, and frame rates .....	48
Exposure time values.....	48
Bandwidth.....	48
Frame rates with Cropping/ROI frame rates .....	49
Typical operation .....	49
Triggering.....	50
Sensor shutter types.....	50
Power consumption .....	50
Dimensions .....	50
Alvium 1500 C model specifications .....	51
Alvium 1500 C-050m/c.....	51
Absolute QE .....	53
Spectral response.....	53
Frame rates with Cropping .....	54
Alvium 1500 C-120m/c.....	55
Absolute QE .....	57
Spectral response.....	57
Frame rates with Cropping .....	58
Alvium 1500 C-210m/c.....	59
Absolute QE .....	61

Spectral response . . . . .	61
Frame rates with Cropping . . . . .	62
Alvium 1500 C-500m/c . . . . .	63
Absolute QE . . . . .	65
Spectral response . . . . .	65
Frame rates with Cropping . . . . .	66
Alvium 1500 C-501m/c NIR . . . . .	67
Absolute QE . . . . .	69
Spectral response . . . . .	69
Frame rates with Cropping . . . . .	70
Alvium 1800 C model specifications . . . . .	71
Alvium 1800 C-040m/c . . . . .	71
Absolute QE . . . . .	73
Spectral response . . . . .	73
Frame rates with Cropping . . . . .	74
Alvium 1800 C-158m/c . . . . .	75
Absolute QE . . . . .	77
Spectral response . . . . .	77
Frame rates with Cropping . . . . .	78
Alvium 1800 C-240m/c . . . . .	79
Absolute QE . . . . .	81
Spectral response . . . . .	81
Frame rates with Cropping . . . . .	82
Alvium 1800 C-319m/c . . . . .	83
Absolute QE . . . . .	85
Spectral response . . . . .	85
Frame rates with Cropping . . . . .	86
Alvium 1800 C-507m/c . . . . .	87
Absolute QE . . . . .	89
Spectral response . . . . .	89
Frame rates with Cropping . . . . .	90
Alvium 1800 C-508m/c . . . . .	91
Absolute QE . . . . .	93
Spectral response . . . . .	93
Frame rates with Cropping . . . . .	94
Alvium 1800 C-511m/c . . . . .	95
Absolute QE . . . . .	97
Spectral response . . . . .	97
Frame rates with Cropping . . . . .	98
Alvium 1800 C-811m/c . . . . .	99
Absolute QE . . . . .	101
Spectral response . . . . .	101
Frame rates with Cropping . . . . .	102
Alvium 1800 C-1236m/c . . . . .	103
Absolute QE . . . . .	105
Spectral response . . . . .	105
Frame rates with Cropping . . . . .	106
Alvium 1800 C-1240m/c . . . . .	107

Absolute QE . . . . .	109
Spectral response . . . . .	109
Frame rates with Cropping . . . . .	110
Alvium 1800 C-1242m/c. . . . .	111
Absolute QE . . . . .	113
Spectral response. . . . .	113
Frame rates with Cropping . . . . .	114
Alvium 1800 C-1620m/c. . . . .	115
Absolute QE . . . . .	117
Spectral response. . . . .	117
Frame rates with Cropping . . . . .	118
Alvium 1800 C-2040m/c. . . . .	119
Absolute QE . . . . .	121
Spectral response. . . . .	121
Frame rates with Cropping . . . . .	122
Alvium 1800 C-2050m/c. . . . .	123
Absolute QE . . . . .	125
Spectral response . . . . .	125
Frame rates with Cropping . . . . .	126
Alvium 1800 C-2460m/c. . . . .	127
Absolute QE . . . . .	129
Spectral response. . . . .	129
Frame rates with Cropping . . . . .	130
White balance default. . . . .	131
Dimensions and mass . . . . .	132
Technical drawings . . . . .	132
Bare Board. . . . .	133
Open Housing S-Mount . . . . .	135
Open Housing CS-Mount . . . . .	136
Open Housing C-Mount . . . . .	137
Lens mounts and maximum protrusion . . . . .	138
IR cut filter . . . . .	139
Sensor position accuracy . . . . .	140
Sensor shift and rotation . . . . .	140
Sensor tilt. . . . .	141
<b>Lenses: Focal length vs. field of view</b> . . . . .	<b>142</b>
About this chapter. . . . .	143
Parameters in tables. . . . .	143
Optical vignetting with certain lenses . . . . .	143
About S-Mount lenses. . . . .	144
Focal length vs. field of view . . . . .	144
Alvium 1500 C-050m/c. . . . .	144
Alvium 1500 C-120m/c. . . . .	145
Alvium 1500 C-210m/c. . . . .	145
Alvium 1500 C-500m/c, 1500 C-501m/c NIR . . . . .	146
Alvium 1800 C-040m/c, 1800 C-158m/c. . . . .	146
Alvium 1800 C-240m/c. . . . .	147
Alvium 1800 C-319m/c. . . . .	147

Alvium 1800 C-507m/c, 1800 C-508m/c . . . . .	148
Alvium 1800 C-511m/c . . . . .	148
Alvium 1800 C-811m/c . . . . .	149
Alvium 1800 C-1236m/c . . . . .	149
Alvium 1800 C-1240m/c . . . . .	150
Alvium 1800 C-1242m/c . . . . .	150
Alvium 1800 C-1620m/c . . . . .	151
Alvium 1800 C-2040m/c . . . . .	151
Alvium 1800 C-2050m/c . . . . .	152
Alvium 1800 C-2460m/c . . . . .	152
<b>Camera control</b> . . . . .	<b>153</b>
Access modes . . . . .	154
Access modes data flow . . . . .	155
V4L2 controls and register controls . . . . .	156
<b>Installing the hardware</b> . . . . .	<b>157</b>
Touching hot cameras . . . . .	158
Scope of instructions . . . . .	158
Software installation . . . . .	158
Hardware installation . . . . .	158
Bare board cameras . . . . .	158
Serial numbers of Alvium® chips and bare board cameras . . . . .	159
Connecting FPC cable and FPC connectors . . . . .	160
Mounting the heat sink . . . . .	162
Mounting the camera . . . . .	163
Mounting bare board cameras . . . . .	163
Mounting open housing cameras . . . . .	164
Bottom or top mounting . . . . .	164
Front mounting . . . . .	165
Adapting maximum torque values . . . . .	165
Mounting the lens . . . . .	166
Mounting and focusing S-Mount lenses . . . . .	167
<b>Camera interfaces</b> . . . . .	<b>170</b>
Recommended accessories . . . . .	171
Back panel . . . . .	171
FPC connector pin assignment . . . . .	172
Non-isolated, programmable GPIOs . . . . .	174
GPIOs description . . . . .	174
Input levels . . . . .	175
Output levels . . . . .	175
Status LED . . . . .	176
Normal operation . . . . .	176
Error conditions . . . . .	176
<b>Triggering</b> . . . . .	<b>177</b>
Availability of triggering controls . . . . .	178
Trigger signal flow . . . . .	178

Trigger latency . . . . .	179
Triggering with rolling shutter cameras . . . . .	179
Trigger delay with 1500 C-120 cameras . . . . .	180
<b>Image data flow</b>	<b>181</b>
<b>Performance</b>	<b>183</b>
Image transfer with rolling shutter cameras . . . . .	184
Frame rate jitter . . . . .	184
Feature value changes on a streaming camera . . . . .	184
Value changes by control interdependencies . . . . .	185
Effects for the interdependent controls . . . . .	185
Impact by other controls . . . . .	186
Exposure times and frame rates with rolling shutter cameras . . . . .	186
Dark current compensation . . . . .	187
Additional compensation . . . . .	188
Black level compensation for 1500 C-050m/c . . . . .	188
Shutter types affecting image readout . . . . .	189
Limitations for available resolutions . . . . .	190
Dependencies between camera and host . . . . .	190
Example . . . . .	191
<b>Index</b>	<b>192</b>

# Document history and conventions



This chapter includes:

Document history .....	25
Conventions used in this user guide.....	28
Naming and terms .....	29



# Document history

Version	Date	Remarks
V2.5.1	2021-Aug-12	<ul style="list-style-type: none"> <li>Added icon for compliance with UKCA in <a href="#">Compliance notifications</a> on page 33.</li> <li>Applied minor editorial changes.</li> </ul>
V2.5.0	2021-Aug-04	<ul style="list-style-type: none"> <li>Added 1500 C-120 to <a href="#">Frame rate jitter</a> on page 184 and <a href="#">Trigger delay with 1500 C-120 cameras</a> on page 180.</li> <li>Added 1500 C-501m/c NIR model in <a href="#">Specifications</a> on page 43.</li> <li>Added 1800 C-511m/c, 1800 C-811m/c, 1800 C-1242m/c, 1800 C-1620m/c, and 1800 C-2040m/c models in <a href="#">Specifications</a> on page 43 and in <a href="#">Lenses: Focal length vs. field of view</a> on page 142.</li> <li>Updated tables with ROI frame rates, including bandwidth per lane in <a href="#">Specifications</a> on page 43.</li> <li>Reduced contents in <a href="#">Camera control</a> on page 153 (previous title: V4L2 controls vs. GenICam features).</li> <li>Applied minor editorial changes.</li> </ul>
V2.4.0	2021-Apr-08	<ul style="list-style-type: none"> <li>Added RAW pixel formats for 10-bit and 12-bit Mono in <a href="#">Specifications</a> on page 43.</li> <li>Added 1800 C-2460m/c models in <a href="#">Specifications</a> on page 43.</li> <li>Updated mass values in <a href="#">Dimensions and mass</a> on page 132.</li> <li>Updated descriptions in <a href="#">Camera control</a> on page 153.</li> <li>Updated instructions for <a href="#">Mounting the camera</a> on page 163.</li> <li>Updated graphic in <a href="#">Value changes by control interdependencies</a> on page 185.</li> <li>Applied minor editorial changes.</li> </ul>

Table 3: Document history (sheet 1 of 3)

Version	Date	Remarks
V2.3.0	2020-Dec-15	<ul style="list-style-type: none"> <li>Updated ROI frame rates and values for minimum and maximum exposure time in <a href="#">Specifications</a> on page 43.</li> <li>Added content about <a href="#">Pixel format default and naming</a> on page 47.</li> <li>Added values for <a href="#">White balance default</a> on page 131.</li> <li>Updated drawings and dimension values for bare board cameras in <a href="#">Technical drawings</a> on page 132.</li> <li>Updated tables in <a href="#">Camera control</a> on page 153.</li> <li>Added information about <a href="#">Serial numbers of Alvium® chips and bare board cameras</a> on page 159.</li> <li>Added <a href="#">Non-isolated, programmable GPIOs</a> on page 174.</li> <li>Added <a href="#">Triggering</a> on page 177.</li> <li>In <a href="#">Image data flow</a> on page 181, added FPNC support for all models, except for Alvium 1800 C-2050.</li> <li>Added notes about frame rates for rolling shutter cameras run in triggered mode.</li> <li>Added content about <a href="#">Limitations for available resolutions</a> on page 190.</li> <li>Applied minor editorial changes.</li> </ul>
V2.2.0	2020-Jul-22	<ul style="list-style-type: none"> <li>Added Alvium 1800 C-240m/c, 1800 C-508m/c, and 1800 C-1240m/c models.</li> <li>Updated ROI frame rates and pixel formats in <a href="#">Specifications</a> on page 43.</li> <li>Updated Type for <a href="#">Alvium 1500 C-210m/c</a> on page 59.</li> <li>Added QE and spectral response to <a href="#">Alvium 1800 C-2050m/c</a> on page 123.</li> <li>Extended information in <a href="#">Shock and vibration</a> on page 44.</li> <li>Updated spectral response graphic in <a href="#">IR cut filter</a> on page 139.</li> <li>Added <a href="#">Sensor position accuracy</a> on page 140.</li> <li>Added <a href="#">Read before use</a> on page 2.</li> <li>Corrected minor errors.</li> </ul>

Table 3: Document history (sheet 2 of 3)

Version	Date	Remarks
V2.1.3	2020-Mar-12	<ul style="list-style-type: none"> <li>Corrected maximum exposure times.</li> <li>DPC: Removed specifications into an application note.</li> <li>FPNC: Updated note in <a href="#">Image data flow</a> on page 181.</li> </ul>
V2.1.2	2020-Mar-04	Applied minor changes.
V2.1.1	2020-Feb-28	Updated content for shutter types.
V2.1.0	2020-Feb-20	<ul style="list-style-type: none"> <li>Added Alvium 1800 C-319m/c, 1800 C-507m/c, 1800 C-1236m/c, and 1800 C-2050m/c models.</li> <li>Added specifications for DPC.</li> <li>Updated description for sensor shutter types.</li> </ul>
V2.0.0	2020-Jan-06	<ul style="list-style-type: none"> <li>Added Alvium 1500 C-210m/c, 1800 C-040m/c, and 1800 C-158m/c models.</li> <li>Added descriptions for Hue and Saturation in <a href="#">Camera control</a> on page 153.</li> <li>Added <a href="#">Dark current compensation</a> on page 187.</li> <li>Updated technical drawings and dimensions for bare board cameras in <a href="#">Dimensions and mass</a> on page 132.</li> <li>Updated values for power consumption in <a href="#">Specifications</a> on page 43.</li> <li>Restructured contents in <a href="#">Performance</a> on page 183.</li> <li>Applied editorial changes.</li> </ul>
V1.1.0	2019-Jul-01	<ul style="list-style-type: none"> <li>Removed separate bit depth for maximum frame rates in <a href="#">Specifications</a> on page 43.</li> <li>Corrected ADC bit depth for Alvium 1500 C-500m/c in <a href="#">Specifications</a> on page 43 and for all models in <a href="#">Image data flow</a> on page 181.</li> </ul>
V1.0.0	2019-Jun-04	Release version

Table 3: Document history (sheet 3 of 3)

# Conventions used in this user guide

To give this document an easily understood layout and to emphasize important information, the following typographical styles and symbols are used:

## Typographic styles

Style	Function
<b>Emphasis</b>	Programs, or highlighting important things
Feature and register names	Names for GenICam features or for camera control registers
<i>Feature and register options</i>	Options for GenICam features or for camera control registers
<i>Input commands</i>	Text or command to type in by the user, selected menu options, or other selectable options
<b>UIElements</b>	Text that is displayed or output by the system, like parts of the GUI, dialog boxes, buttons, menus, important information, or windows titles
<a href="#">Web addresses and references</a>	Links to webpages and internal cross references

Table 4: Typographic styles

## Symbols and notes



### CAUTION

#### Risk of burns

Precautions are described



### CAUTION

#### Injury by falling cameras or lenses

Precautions are described



### CAUTION

#### Risk of cuts by sharp edges of lens mounts

Precautions are described

**NOTICE**
**Material damage**

Precautions are described.

**Practical tip**

Additional information helps to understand or ease handling the camera.

**Avoiding malfunctions**

Precautions are described.

**Additional information**

Web address or reference to an external source with more information is shown.

## Naming and terms

### Camera model naming

Alvium cameras are named to identify model properties.  
For example, **Alvium 1500 C-500c** is composed of:

	<b>Alvium</b>	<b>1500</b>	<b>C</b>	<b>500</b>	<b>c</b>
<b>Content element</b>	Camera series	Camera series detail	Interface	Resolution <sup>1</sup>	Color/ monochrome
<b>Examples</b>	Alvium	1500: Basic feature set 1800: Advanced feature set or high-performance sensors	C: MIPI CSI-2 U: USB	500: 5.0 MP 050: 0.5 MP	c: color m: monochrome

<sup>1</sup>Model resolutions may slightly deviate from model naming.

Table 5: Camera model naming

**Hardware options**

Alvium CSI-2 cameras are available as bare board or open housing models with different lens mounts. For ordering, see hardware options and product codes in the Alvium Cameras Hardware Options document at [www.alliedvision.com/en/support/technical-documentation/alvium-csi-2-documentation](http://www.alliedvision.com/en/support/technical-documentation/alvium-csi-2-documentation).

## Terms and acronyms

Term or acronym	Description	Reference
adapter board	Printed circuit board (PCB) that connects embedded boards, cameras, and I/Os, dedicated to an individual embedded board	Alvium Cameras Accessory Guide at <a href="http://www.alliedvision.com/en/support/technical-documentation/alvium-csi-2-documentation">www.alliedvision.com/en/support/technical-documentation/alvium-csi-2-documentation</a> .
bare board	Camera consisting of electronics and sensor on a common printed circuit board (PCB), to be designed into a housing with heat sink and lens mount	<a href="#">Bare Board</a> on page 133
CRA	Chief ray angle	<a href="#">Alvium 1500 C-050m/c</a> on page 51
EMVA	European Machine Vision Association	<a href="http://www.emva.org">www.emva.org</a>
ERS	Electronic rolling shutter, see RS	<a href="#">Shutter types affecting image readout</a> on page 189
ESD	Electrostatic discharge	<a href="#">ESD</a> on page 37
FPC cable	(MIPI CSI-2 FPC cable) Flexible printed circuit cable, component that connects embedded boards and cameras via adapter board	Alvium Cameras Accessory Guide at <a href="http://www.alliedvision.com/en/support/technical-documentation/alvium-csi-2-documentation">www.alliedvision.com/en/support/technical-documentation/alvium-csi-2-documentation</a> .
FPC connector	Hirose FH55-22S-0.5SH connector	<a href="http://www.hirose.com">www.hirose.com</a>
FPNC	Fixed pattern noise correction	<a href="#">Image data flow</a> on page 181
fps	Frames per second	<a href="#">Alvium 1500 C-050m/c</a> on page 51
GND	Ground (power)	<a href="#">FPC connector pin assignment</a> on page 172
Gbps	Gigabit per second	<a href="#">Alvium 1500 C-050m/c</a> on page 51
GS	Global shutter	<a href="#">Shutter types affecting image readout</a> on page 189
H × V	Horizontal × Vertical (sensor resolution)	<a href="#">Alvium 1500 C-050m/c</a> on page 51
PCB	Printed circuit board	<a href="#">Connecting FPC cable and FPC connectors</a> on page 160
PCBA	Printed circuit board assembly	<a href="#">PCBAs</a> on page 38
open housing	Camera housing that is open at the back side to be designed into an encompassing housing with other components	<a href="#">Open Housing C-Mount</a> on page 137
QE	Quantum efficiency	<a href="#">Absolute QE</a> on page 53
ROI	Region of interest	<a href="#">V4L2 controls and register controls</a> on page 156
RS	Rolling shutter, see ERS	<a href="#">Shutter types affecting image readout</a> on page 189

Table 6: Terms and acronyms (sheet 1 of 2)

Term or acronym	Description	Reference
SFNC	Standard Feature Naming Convention (GenICam)	<a href="http://www.emva.org">www.emva.org</a>
S-Mount	M12-Mount	<a href="#">Mounting and focusing S-Mount lenses</a> on page 167

Table 6: Terms and acronyms (sheet 2 of 2)

# Compliance, safety, and intended use



This chapter includes:

Compliance notifications .....	33
Intended use .....	34
Copyright and trademarks .....	34
Your safety .....	35
Product safety .....	37



## Compliance notifications



National regulations on disposal must be followed.

### Bare board and open housing cameras

Bare board and open housing cameras are designed for integration and are delivered without closed housing on customer's request. Housing design is critical for electromagnetic compatibility (EMC) of the camera.



#### Requirements for EMC housings

See the Electromagnetic Compatibility for Open Housing Alvium Cameras application note at [www.alliedvision.com/en/support/technical-documentation/alvium-csi-2-documentation](http://www.alliedvision.com/en/support/technical-documentation/alvium-csi-2-documentation).

### Avoid electromagnetic interferences

Interface cables, power cables, and I/O cables are sensitive to electromagnetic interference.

- Use shielded cables only.
- We recommend using cables offered by Allied Vision.
- Avoid coiling.
- We recommend using GPIOs only in environments with low electromagnetic interference.

Moreover, avoid unnecessary bending to prevent damaging the cables.

## Intended use

Allied Vision's objective is the development, design, production, maintenance, servicing and distribution of digital cameras and components for image processing. We are offering standard products as well as customized solutions.

Intended use of Allied Vision product is the integration into Vision systems by professionals. All Allied Vision product is sold in a B2B setting.

Allied Vision isn't a legal manufacturer of medical product. Instead, Allied Vision cameras and accessories may be used as components for medical product after design-in by the medical device manufacturer and based on a quality assurance agreement (QAA) between Allied Vision (supplier) and medical device manufacturer (customer). Allied Vision's duties in that respect are defined by ISO 13485, clause 7.2 (customer-related processes, equivalent to ISO 9001, clause 8.2).

## Copyright and trademarks

All text, pictures, and graphics are protected by copyright and other laws protecting intellectual property. All content is subject to change without notice.

All trademarks, logos, and brands cited in this document are property and/or copyright material of their respective owners. Use of these trademarks, logos, and brands does not imply endorsement.

Copyright © 2021 Allied Vision Technologies GmbH. All rights reserved.

## Your safety

This section informs about issues related to your personal safety. Descriptions explain how to avoid hazards and operate Alvium CSI-2 cameras safely.

### Handling lens mounts

The lens mount thread has sharp edges. Be careful these edges do not cut your skin when mounting or unmounting lenses.

### Housed cameras: handling hot cameras

If the mainboard temperature exceeds the specified maximum for more than two seconds, the camera is powered off automatically. The current value for mainboard temperature is output by `Device Temperature`, using Direct Register Access. You can use this value to control cooling by software, for example, to control a fan.

However, if you hold the camera in your hands during operation, your skin may get hurt. If you touch the camera when it is heated up, we recommend wearing protective gloves.

### Providing optimum heat dissipation

Design bare board and open housing cameras into a heat dissipative housing with a high thermal conductivity. For more information, see [Mounting bare board cameras](#) on page 163. Keep the operating temperature in the specified range to enable best image quality and to protect the camera from damage. Temperature values apply to a relative humidity of 0 to 80 percent that is non-condensing.

Hardware option	Housing	Components in the cooling areas <sup>1</sup>	Mainboard <sup>2</sup>
Bare board <sup>3</sup>	Not applicable	+5 °C to +85 °C	See model <a href="#">Specifications</a> on page 43.
Open housing <sup>4</sup>	+5 °C to +65 °C		

<sup>1</sup>See [Mounting the heat sink](#) on page 162.

<sup>2</sup>Output by `Device Temperature`, using Direct Register Access.

<sup>3</sup>Ensure that the sensor is operated in the temperature range specified by the manufacturer. For any questions, please visit [www.alliedvision.com/en/support](http://www.alliedvision.com/en/support).

<sup>4</sup>Temperature values must be observed for the housing **and** for the cooling areas.

*Table 7: Operating temperature ranges for Alvium CSI-2 cameras*

For your safety and to improve camera performance, operate the camera:

- Mounted to a base with a high thermal conductivity
- With lens or other optical components mounted
- With a heat sink mounted that has large surface areas (closed housing cameras include a heat sink)
- Using conductive media for camera and heat sink mounting
- With active cooling of camera, mounting base, and heat sink, such as by ventilation.

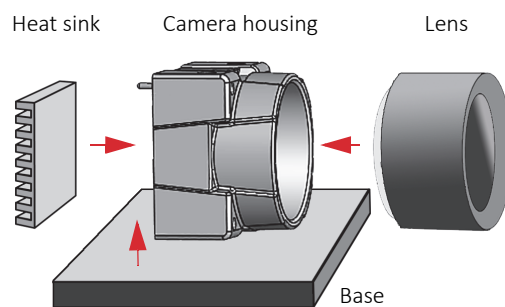

Figure 1: Setup to provide optimum heat dissipation



#### More information

For more information on heat dissipation, see the Optimum Heat Dissipation for Housed Alvium Cameras application note at [www.alliedvision.com/en/support/technical-documentation/alvium-csi-2-documentation](http://www.alliedvision.com/en/support/technical-documentation/alvium-csi-2-documentation).

## Camera mounting

Housed cameras must be mounted using the mounting threads. If vibration is higher than specified, cameras can disconnect from the mounting. Falling cameras can hurt you. To avoid personal injury:

- Mount the camera according to the instructions in [Mounting open housing cameras](#) on page 164.
- Ensure, shock and vibration do not exceed the specified range, see [Shock and vibration](#) on page 44.
- Use a lens support if you want to use [Heavy lenses](#).

## Heavy lenses

For non-static applications, use lenses with a mass less than 70 grams and a length less than 38 mm, where the center of gravity is 20 mm, measured from the lens mount front flange. For heavier or longer lenses, use a lens support and apply additional tests. For more information, please visit [www.alliedvision.com/en/support](http://www.alliedvision.com/en/support).

# Product safety

To prevent material damage, read the following and understand how to safely handle and operate the camera.

## Embedded systems

Setup and operation of Alvium CSI-2 cameras in embedded systems is different than for cameras in PC-based systems. Components can easily be damaged.

If you are unfamiliar with embedded systems, be extremely careful. Follow the instructions in [Installing the hardware](#) on page 157.

## Supported embedded boards

We have tested that Alvium CSI-2 cameras can be operated properly with the referenced embedded boards. For information on using these components safely, please see the documentation provided by the manufacturers of the embedded boards.

## Electrical connections

The MIPI CSI-2 standard does not specify electrical connections as extensively as the USB or GigE standard. Read specifications carefully.

Allied Vision accessories help to avoid damage to the camera and connected components. See the Alvium Cameras Accessory Guide for suitable accessories. See [Specifications](#) on page 43 and [Installing the hardware](#) on page 157.

Alvium CSI-2 cameras are not protected against damage caused by reverse polarity.

- For specifications, see [FPC connector pin assignment](#) on page 172.
- For instructions to avoid electronics damage, see [Connecting FPC cable and FPC connectors](#) on page 160.

## ESD

ESD is dangerous for electronic devices, especially when tools or hands get in contact with connectors and electronic components. We recommend measures to avoid damage by ESD:

- Unpacking: Remove the camera from its anti-static packaging only when your body is grounded.
- Workplace: Use a static-safe workplace with static-dissipative mat and air ionization.
- Wrist strap: Wear a static-dissipative wrist strap to ground your body.

- Clothing: Wear ESD clothing. Keep components away from your body and clothing. Even if you are wearing a wrist strap, your body is grounded but your clothes are not.
- Housing: use an ESD housing, including the camera, embedded board, adapter board, and MIPI CSI-2 FPC cable.

## Cable connections

Provide sufficient strain relief for all cable connections to avoid short circuits and malfunctions.

## PCBAs

Alvium CSI-2 cameras enable access to PCBAs. Keep away from camera electronics to avoid damage.

## Camera power

Operating cameras beyond the specified range damages cameras. Cameras are powered using the FPC connector at a maximum input of 5.5 VDC with maximum 1.5 A, using a limited power source (LPS), according to IEC 62368-1. The camera is not intended to be connected to a DC distribution network.

Only use power supplies that meet the insulation requirement according to PELV or SELV. For details, please refer to IEC 61140.

## Ground loops

Unsuitable connections can lead to different potentials between the camera system GND and the environmental shield/chassis GND caused by ground loops. This can damage the camera and the connected devices or cause malfunctions.

- Avoid potential differences between the camera housing and GND.
- All wiring must be done by authorized personnel, according to the corresponding technical standards.
- You may mount the camera electrically isolated.
- Read the Avoiding Ground Loops in Vision Systems application note.



### More information

See the Avoiding Ground Loops in Vision Systems application note at [www.alliedvision.com/en/support/technical-documentation/alvium-csi-2-documentation](http://www.alliedvision.com/en/support/technical-documentation/alvium-csi-2-documentation).

## FPC connectors

Hirose FH55-22S-0.5SH FPC connectors enable compact camera design.

The small-sized connectors are sensitive to mechanical stress and are specified for maximum 20 mating and unmating cycles. Especially if you are inexperienced with this connector, be very cautious. If the FPC connector is broken, the camera must be replaced. To install and operate cameras safely, read this section carefully.

Instructions in [Installing the hardware](#) on page 157 include helpful information to enable proper installation.

- Avoid stress to FPC connectors.
- Allow only the FPC cable to touch conductors.

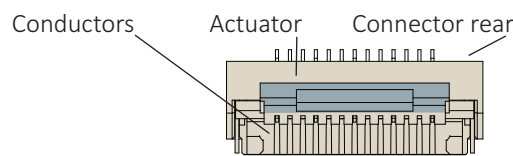

Figure 2: Hirose FH55-22S-0.5SH FPC connector



### Additional information

For technical data and more instructions on the Hirose FH55-22S-0.5SH connector, see the manufacturer data sheet at [www.hirose.com](http://www.hirose.com).

### Handling the actuator

- Move the actuator only between 0 degrees (locked position) and 105 degrees (open position).
- Carefully flip the actuator at the middle with your finger nail, see [Connecting FPC cable and FPC connectors](#) on page 160.

## MIPI CSI-2 FPC cables



### Manufacturing FPC cables or embedded boards

If you want to design your own components to connect Alvium CSI-2 cameras to embedded boards, contact your Allied Vision Sales representative or contact Support on [www.alliedvision.com/en/about-us/contact-us/technical-support-repair-/-rma](http://www.alliedvision.com/en/about-us/contact-us/technical-support-repair-/-rma).

### FPC cable position

Short circuits of the FPC cable can damage the camera or connected hardware.

- Insert the FPC cable into the connector with cable guiding tabs matching the connector's side guides. See [Connecting FPC cable and FPC connectors](#) on page 160.

- Connect the camera and the embedded board (adapter) only as shown by the arrow printed on the FPC cable, see [Connecting FPC cable and FPC connectors](#) on page 160.

### **FPC cables and stress**

Over-stressed FPC cables can damage the camera and connected hardware. When camera and embedded board are twisted against each other or pulled apart from each other with too much force, the FPC cable is over-stressed. Spring contacts of FPC connectors are worn out, causing short circuits and unreliable electrical connections.

- Insert the FPC cable into the FPC connector at 12 degrees to the PCB board surface. See [Connecting FPC cable and FPC connectors](#) on page 160.
- Allow only slight bending of the FPC cable (minimum bending radius: 10 mm).
- Provide strain relief to avoid short cuts and malfunctions.

### **No hot-plugging for MIPI CSI-2**

Alvium CSI-2 cameras do not support hot-plugging. Hot-plugging can destroy the camera and connected hardware by high inrush current.

Disconnect power supplies before connecting FPC cables.

### **FPC cable signal quality**

Noise and electromagnetic interference can disable camera functions.

- Avoid contact to metal surfaces, causing electromagnetic interference.
- Please use cables recommended by Allied Vision.

## **Handling bare board cameras**

Bare board cameras are an electronic assembly without a protective housing. Therefore, they can easily be damaged.

- Handle bare board cameras with extreme care.
- Avoid any mechanical stress to the sensor area.
- Avoid short circuits by keeping away from electronics components.

Observe for mounting bare board cameras:

- Allow mechanical contact only at the mounting area. (This does not apply to the cooling areas.)
- Enable proper cooling at the cooling areas, see [Mounting bare board cameras](#) on page 163.
- Give 2 mm minimum clearance above board components.
- Tighten screws at 0.1 Nm maximum torque.
- Follow the instructions in [Mounting bare board cameras](#) on page 163.



## Optical components

Provide the following conditions to keep dirt and droplets out of the optical system of camera and lens:

- Dust-free environment
- Low relative humidity
- No condensation.

When camera or lens are stored:

- Cover the lens mount with a protection foil or cap.
- Cover front and back lens with caps.



### Damage to optical components by conductive media for heat sinks

See [Conductive media for heat sinks](#) on page 42 for details.

## Sensor

Sensors are sensitive to excessive radiation: focused sunlight, lasers, and X-rays can damage the sensor. Dirt and scratches can damage the sensor as well.

Alvium CSI-2 cameras do not need additional cleaning. Cameras are cleaned before shipping. Incorrect cleaning can damage the sensor or the filter. Therefore, never clean the sensor or the filter.

Protect the camera filter and the sensor from dirt, because dirt becomes more visible the closer it gets to the sensor. In addition, keep the back lens clean. Hold the camera with the lens mount facing the ground to keep dirt out of the lens mount. When no lens is mounted, protect the sensor and filter by a dust cap.

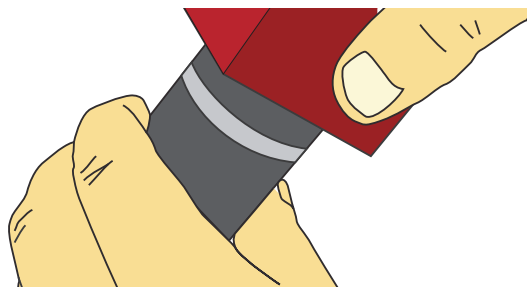
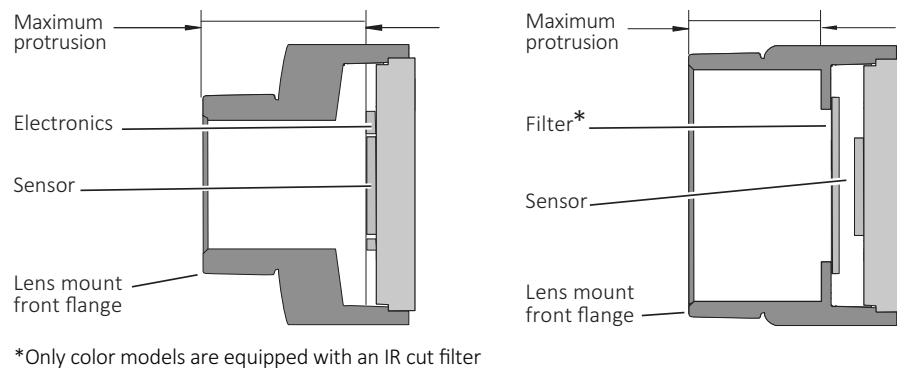

Figure 3: Holding the camera with the lens mount facing the ground

## Lenses

### Maximum protrusion

The sensor, filter, lens, or camera electronics can be damaged if a lens exceeding maximum protrusion is mounted to the camera. Use lenses with a maximum protrusion within camera specifications. [Figure 4](#) shows maximum protrusion. For details, see [Lens mounts and maximum protrusion](#) on page 138.



*Figure 4: Maximum protrusion; S-Mount (left); CS-Mount and C-Mount (right)*

For S-Mount lenses, read [Mounting and focusing S-Mount lenses](#) on page 167 to avoid damage to the sensor, electronics, and lens.

## Heat sinks and conductive media

The camera can be damaged if heat sink or conductive media are not used properly.

### Heat sinks

Adhere to the instructions and safety notes provided by the manufacturer of the heat sink.

### Conductive media for heat sinks

Some conductive media for heat sinks contain corrosive substances that can damage optical surfaces of the sensor, filter, and lens.

- Cover the optical path of the camera when you apply heat sink compound or adhesive to prevent substances and fumes from damaging optical surfaces.
- Adhere to the instructions and safety notes provided by the manufacturer of the conductive media.
- Ensure that the conductive media is correctly positioned: covering only the **cooling areas**, see [Mounting the heat sink](#) on page 162.

# Specifications



This chapter includes:

Applied standards .....	44
Notes on specifications .....	46
Alvium 1500 C model specifications .....	51
Alvium 1800 C model specifications .....	71
White balance default .....	131
Dimensions and mass .....	132
Technical drawings .....	132
Lens mounts and maximum protrusion .....	138
IR cut filter .....	139
Sensor position accuracy .....	140

# Applied standards

## MIPI CSI-2

The MIPI (Mobile Industry Processor Interface) CSI (Camera Serial Interface)-2 standard describes a class of MIPI CSI-2 cameras for still image photography and video streaming. Generically, MIPI CSI-2 cameras are operated by Direct Register Access. Alvium CSI-2 cameras have a MIPI CSI-2 interface. They comply with:

- MIPI CSI-2 V1.1
- D-PHY V1.1.

## V4L2

The current V4L2 framework is described at [linuxtv.org](http://linuxtv.org). Allied Vision provides V4L2 drivers. You can download Allied Vision V4L2 drivers from [www.alliedvision.com/en/products/software/embedded-software-and-drivers](http://www.alliedvision.com/en/products/software/embedded-software-and-drivers).

## Shock and vibration

Alvium closed and open housing cameras were tested according to the following standards:

- IEC 60068-2-6, sinusoidal vibration testing
- IEC 60068-2-27, shock testing
- IEC 60068-2-64, random vibration testing.

Cameras were inspected before and after the tests. All tests were passed successfully:

Condition	Passed
Mechanics	<ul style="list-style-type: none"> <li>• The camera housings showed no deformations.</li> <li>• The connections between camera components had not come loose.</li> <li>• The sensor position was within the specified tolerances of a new camera.</li> </ul>
Camera behavior	Camera functionalities were not affected, no deviations occurred.
Image streaming	Images were streamed without errors.

*Table 8: Conditions for passed tests*

The conditions for cameras and lenses were the same for all tests. Solid aluminum tubes were used to represent real lenses:

Parameter	Value
Lens dummy length	38 mm
Lens dummy mass	70 g
Center of gravity (CoG) <sup>1</sup>	20 mm

<sup>1</sup>For camera and lens dummy assemblies, measured from the lens mount front flange

Table 9: Conditions for lenses

## IEC 60068-2-6: Sinusoidal vibration

Frequency	Acceleration	Displacement
10 Hz to 58.1 Hz	Not applicable	1.5 mm
58.1 Hz to 500 Hz	20 g	Not applicable

Table 10: Frequency, acceleration, and displacement for IEC 60068-6 tests

Parameter	Value
Axis	x, y, z
Sweep rate	1 oct/min
Sweep duration per axis [hh:mm:ss]	00:11:17
Number of sweeps	20

Table 11: Other parameters for IEC 60068-6 tests

## IEC 60068-2-27: Shock

Parameter	Value
Axis	x, y, z
Acceleration	20 g
Number of shocks per axis	10
Duration per axis	11 ms
Waveform	Half sine

Table 12: Parameters for IEC 60068-2-27 tests

## IEC 60068-2-64: Random vibration

Frequency	Acceleration
15 Hz to 500 Hz	0.05 $g^2/_{Hz}$

Table 13: Frequency and acceleration for IEC 60068-2-64 tests

Parameter	Value
Axis	x, y, z
Acceleration RMS (Sigma)	4.9 g
Acceleration peak (Sigma)	14.8 g
Duration per axis [hh:mm:ss]	00:30:00

Table 14: Other parameters for IEC 60068-64 tests

## Notes on specifications

This section defines the conditions for specifications stated in this chapter.

### Sensor

#### Absolute QE plots

Measurements for color cameras were done with IR cut filter, measurements for monochrome and S-Mount cameras were done without optical filters. With optical filters, QE decreases by approximately 10 percent. The uncertainty in measurement of the QE values is  $\pm 10$  percent. This is mainly due to uncertainties in the measuring apparatus itself (such as Ulbricht sphere and optometer).

Manufacturing tolerance of the sensor increases overall uncertainty.

#### Sony sensors

Sony provides relative response curves in their sensor data sheets. To create the absolute QE plots shown in this chapter, the relative response was converted to a normalized QE response and then adjusted as per three measured QE values (at 448 nm, 529 nm, 632 nm) for color sensors and one measured QE value (at 529 nm) for monochrome sensors.

## ON Semiconductor sensors

The curve in the absolute QE plots shown in this chapter is from the sensor manufacturer data sheet. The information was correct at the time of publishing.

## Wavelength

The wavelength range in the absolute QE plots reflects the information available in the sensor manufacturer data sheet at the time of publishing. For additional wavelength information, contact the sensor manufacturer.

## Spectral response plots

The curves in the spectral response plots shown in this chapter were calculated from measured quantum efficiencies at 448 nm, 529 nm, and 632 nm. The shape of the curve is taken from the sensor data sheet but the values have been adjusted based on these measured values. The uncertainty in measurement of the spectral response values is  $\pm 10$  percent.

## Resolution limitations

Different hosts can affect available values for minimum and maximum resolution, and for resolution increments. See [Limitations for available resolutions](#) on page 190.

## Pixel format default and naming

The **default pixel format** for Alvium cameras is RGB888 (RGB3). Monochrome cameras are included to enable quick access on V4L2 where V4L2\_PIX\_FMT\_UYVY is the default. For monochrome cameras, the 3 bytes for RGB are set to a common value, resulting in gray.

### Pixel format naming

- Video4Linux Access: according to V4L2 definitions.
- Direct Register Access: Alvium CSI-2 cameras output pixel formats according to the MIPI CSI-2 standard.

This manual states extended MIPI CSI-2 definitions.

Naming pattern	Examples
MIPI CSI-2 (FOURCC)	RAW8 (GREY) RGB888 (RGB3)

Table 15: Pixel format naming convention in specifications

Different names for equivalent formats:

MIPI CSI-2	V4L2	V4L2 FOURCC	PFNC <sup>1</sup>
YUV422 8-bit	V4L2_PIX_FMT_UYVY	UYVY	YCbCr422_8_CbYCrY
RGB888	V4L2_PIX_FMT_RGB24	RGB3	RGB8
RAW8	V4L2_PIX_FMT_GREY	GREY	Mono8
RAW10	V4L2_PIX_FMT_Y10	Y10	Mono10
RAW12	V4L2_PIX_FMT_Y12	Y12	Mono12

<sup>1</sup>GenICam Pixel Format Naming Convention

Table 16: Equivalent pixel formats in different standards



#### Availability of pixel formats

The availability of pixel formats depends on camera models and the abilities of the connected system.

## Exposure time, bandwidth, and frame rates

### Exposure time values

Interdependencies between controls affect each other. See [Value changes by control interdependencies](#) on page 185.

### Bandwidth

#### CSI-2 Lane Count and CSI-2 Clock

Alvium cameras require higher bandwidths than supported by only one CSI-2 lane, especially with low CSI-2 clock frequencies. We recommend you to do extensive testing to find the best setup for maximum frame rates, regarding:

- CSI-2 lane count
- CSI-2 Clock.

#### Dropped frames or a viewer issue?

Alvium CSI-2 cameras are designed for a maximum bandwidth that does not exceed board abilities. However, if your setup does not provide sufficient bandwidth, frames are dropped. Even if bandwidth is sufficient, embedded boards may not be able to display all images of an image stream. In this case, only the display is affected but no dropped frames occur.



## Frame rates with Cropping/ROI frame rates

Cropping is a functionality similar to ROI. By using a reduced area of the available sensor, the payload is reduced, increasing frame rates. For details, see [Camera control](#) on page 153.

The maximum frame rate which can be achieved depends on various values, such as bandwidth, pixel format, exposure time, and ROI. Calculation of maximum frame rates for different ROIs for Alvium CSI-2 cameras does not allow to give a formula. Data is calculated for...

## Typical operation

- Factory settings (camera after startup)
- Minimum exposure time
- Full resolution
- RAW8 (GREY) pixel format
- Camera operation in freerun mode
- Sensor readout using ADC bit depth
- Without bandwidth limitations.



### Achieved values for your system may not match specified values

Values stated in this chapter show the maximum available on an ideal system, supporting a bandwidth of 1.125 Gbps per lane. Your individual setup may affect available values such as for:

- Minimum **exposure times**
- Maximum **frame rates**, including ROI frame rates
- **Image resolution steps**. Due to increments, some standard resolutions are not available. For example, instead of 1,440 × 900 pixels for WXGA+, 1,440 × 904 pixels are available. See [Limitations for available resolutions](#) on page 190.



### Interdependencies between ROI and Exposure Time values

Changing parameters for ROI can affect values for Exposure Time, such as minimum, maximum, and increments, but Exposure Time itself as well.

We recommend you to **set ROI values before you set values for Exposure Time**.

See [Value changes by control interdependencies](#) on page 185 for details.



### Delays

For delays, see [Trigger latency](#) on page 179.

## Triggering

The following table shows how the shutter type impacts available frame rates. Reducing the area for ROI reduces readout time. The relations in [Table 17](#) apply only if exposure time is shorter than readout time.

Sensor type	Shutter type	Trigger mode	Available frame rates	ROI frame rates
Global shutter (GS)	Global shutter (GS)	Freerun	Maximum values	Increased values
	Global shutter (GS)	External trigger	Maximum values	Increased values
Rolling shutter (RS)	Rolling shutter (RS)	Freerun	Maximum values	Increased values
	Rolling shutter (RS)	External trigger	<b>Halved values</b>	Increased values

*Table 17: Frame rates depending on shutter types and trigger modes*

## Sensor shutter types

Differences between global shutter (GS), rolling shutter (RS) sensors are explained in [Shutter types affecting image readout](#) on page 189. Triggering behavior differs between cameras with global shutter (GS) and rolling shutter (RS). See [Triggering](#) on page 177 for details.

## Power consumption

The power consumption values in this chapter are for **typical operation**:

- Factory settings (camera after startup)
- Minimum exposure time
- Maximum frame rate
- Full resolution
- RAW8 (GREY) pixel format
- Camera operation in freerun mode
- Sensor readout using ADC bit depth
- Without bandwidth limitations.

## Dimensions

For your model's dimensions, see [Dimensions and mass](#) on page 132.

In manufacturing, camera board and sensor are moved against each other to adjust flange focal distance. The value range for camera length with open housing cameras reflects in the technical drawings. See [Technical drawings](#) on page 132.

# Alvium 1500 C model specifications

## Alvium 1500 C-050m/c

Feature	Specification	
	1500 C-050m (monochrome)	1500 C-050c (color)
Sensor model	ON Semiconductor PYTHON 480	
Resolution	808 (H) × 608 (V); 0.5 MP	
Sensor type	CMOS	
Shutter type	Global shutter (GS)	
Sensor size	Type 1/3.6; 3.9 mm × 2.9 mm; 4.9 mm diagonal	
Pixel size	4.8 μm × 4.8 μm	
CRA	1.65 deg	
ADC	10-bit	
YUV color pixel formats	Not applicable	YUV422 8-bit (UYVY)
RGB color pixel formats	Default: RGB888 (RGB3)	
RAW pixel formats	RAW8 (GREY), RAW10 (Y10)	
Maximum image bit depth	10-bit	
Maximum frame rate	117 fps, using 1 to 4 lanes	
Exposure time	64 μs to 10 s (1 to 4 lanes)	
Image buffer (RAM)	256 KB	
Non-volatile memory (Flash)	1024 KB	
Gain	0 dB to 11 dB; 0.1 dB increments	
GPIOs	2 programmable GPIOs As direct inputs (push-pull): 0 to 5.5 VDC As direct outputs (push-pull): 0 to 3.3 VDC at 12 mA	
Power requirements	Power over MIPI CSI-2	
Power consumption (typical, at 5 VDC)	1.3 W	

Table 18: Alvium 1500 C-050m/c specifications (sheet 1 of 2)

Feature	Specification			
	1500 C-050m/c			
Operating temperature	<b>Hardware option</b>	<b>Housing</b>	<b>Cooling areas<sup>1</sup></b>	<b>Mainboard<sup>2</sup></b>
	Bare board <sup>3</sup>	Not applicable	+5 °C to +85 °C	+5 °C to +85 °C
Open housing <sup>4</sup>	+5 °C to +65 °C			
Relative humidity	0% to 80% (non-condensing)			
Digital interface	MIPI CSI-2 D-PHY V1.1; 1, 2, or 4 lanes; maximum 1.125 Gbps per lane			
Camera controls	V4L2 controls (Video4Linux Access), Direct Register Access			
<sup>1</sup> See <a href="#">Mounting the heat sink</a> on page 162. <sup>2</sup> Output by <b>Device Temperature</b> <sup>3</sup> Ensure that the sensor is operated in the temperature range specified by the manufacturer. For any questions, please visit <a href="http://www.alliedvision.com/en/support">www.alliedvision.com/en/support</a> . <sup>4</sup> Temperature values must be observed for the housing <b>and</b> for the cooling areas.				

Table 18: Alvium 1500 C-050m/c specifications (sheet 2 of 2)

### Absolute QE

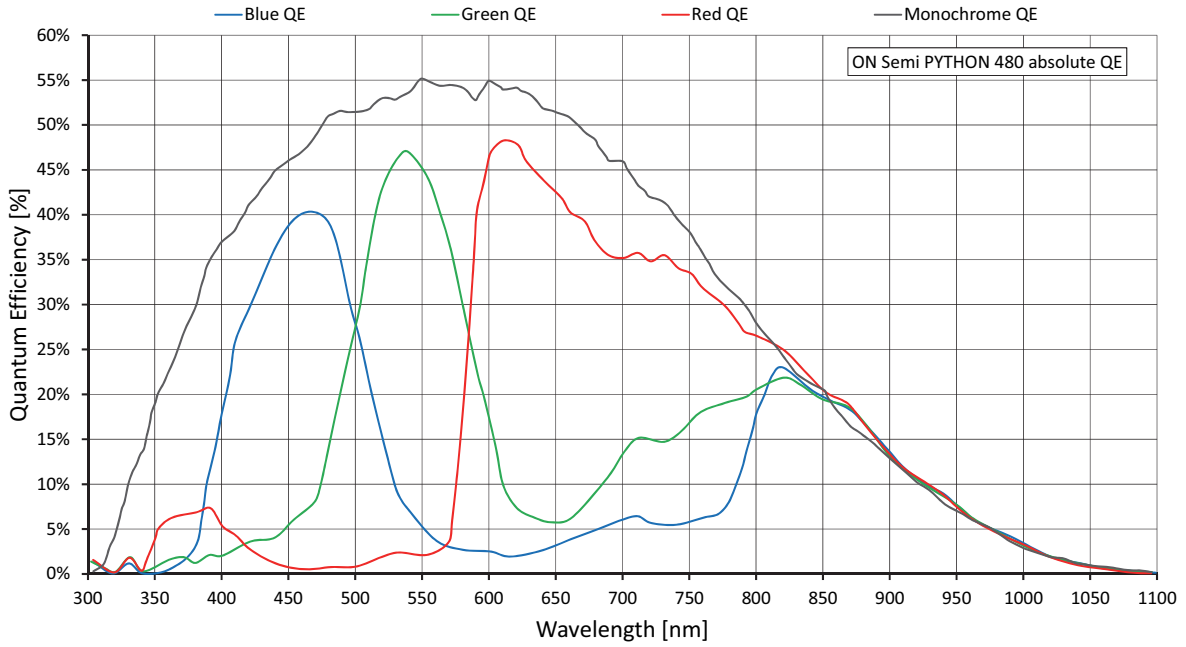

Figure 5: Alvium 1500 C-050m/c (ON Semi PYTHON 480) absolute QE

### Spectral response

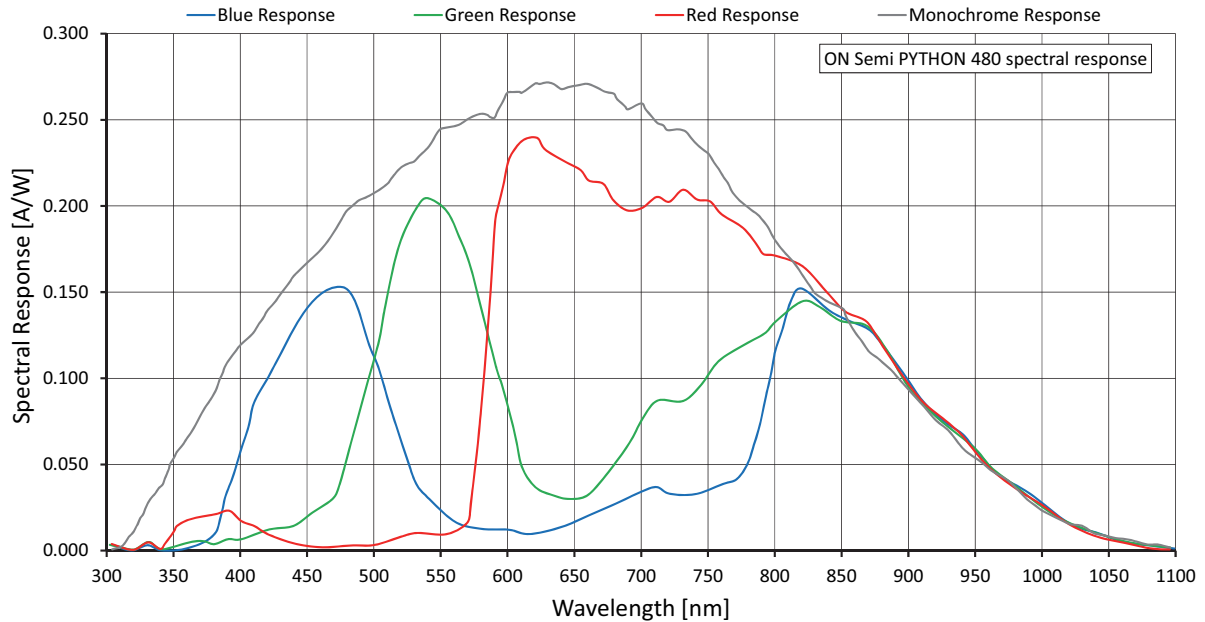

Figure 6: Alvium 1500 C-050m/c (ON Semi PYTHON 480) spectral response

## Frame rates with Cropping

Values were calculated for **typical operation** defined in [Frame rates with Cropping/ROI frame rates](#) on page 49.

Frame rates at maximum bandwidth calculates for 1.051 Gbps per lane. To reach the maximum frame rate available for typical operation, the bandwidth for image traffic is at 1 lane with 1.051 Gbps. Increasing the CSI-2 Lane Count value does not increase frame rates.

Image format	Width [pixels]	Height [pixels]	ROI area [pixels]	Frame rate [fps]		
				4-lane	2-lane	1-lane
				4.204 Gbps	2.102 Gbps	1.051 Gbps
Full resolution	808	608	491,264	117		
SVGA	800	600	480,000	119		
VGA	640	480	307,200	176		
HVGA	480	320	153,600	313		
QVGA	320	240	76,800	514		
HQVGA	240	160	38,400	784		
QQVGA	160	120	19,200	1,069		
Maximum × half	808	304	245,632	219		
Maximum × minimum	808	16	12,928	1,278		
Minimum × maximum	16	608	9,728	726		
Minimum × minimum	16	16	256	1,943		

Table 19: Alvium 1500 C-050m/c ROI frame rates at maximum bandwidth

## Alvium 1500 C-120m/c

Feature	Specification	
	1500 C-120m (monochrome)	1500 C-120c (color)
Sensor model	ON Semiconductor AR0135CS	
Resolution	1280 (H) × 960 (V); 1.2 MP	
Sensor type	CMOS	
Shutter type	Global shutter (GS)	
Sensor size	Type 1/3; 4.8 mm × 3.6 mm; 6.0 mm diagonal	
Pixel size	3.75 μm × 3.75 μm	
CRA	0 deg	
ADC	12-bit	
YUV color pixel formats	Not applicable	YUV422 8-bit (UYVY)
RGB color pixel formats	Default: RGB888 (RGB3)	
RAW pixel formats	RAW8 (GREY), RAW10 (Y10), RAW12 (Y12)	
Maximum image bit depth	12-bit	
Maximum frame rate	52 fps, using 1 to 4 lanes	
Exposure time	57 μs to 12.2 s (1 to 4 lanes)	
Image buffer (RAM)	256 KB	
Non-volatile memory (Flash)	1024 KB	
Gain	0 dB to 18 dB; 0.1 dB increments	
GPIOs	2 programmable GPIOs As direct inputs (push-pull): 0 to 5.5 VDC As direct outputs (push-pull): 0 to 3.3 VDC at 12 mA	
Power requirements	Power over MIPI CSI-2	
Power consumption (typical, at 5 VDC)	1.1 W	

Table 20: Alvium 1500 C-120m/c specifications (sheet 1 of 2)

Feature	Specification			
	1500 C-120m/c			
Operating temperature	Hardware option	Housing	Cooling areas <sup>1</sup>	Mainboard <sup>2</sup>
	Bare board <sup>3</sup>	Not applicable	+5 °C to +85 °C	+5 °C to +85 °C
Open housing <sup>4</sup>	+5 °C to +65 °C			
Relative humidity	0% to 80% (non-condensing)			
Digital interface	MIPI CSI-2 D-PHY V1.1; 1, 2, or 4 lanes; maximum 1.125 Gbps per lane			
Camera controls	V4L2 controls (Video4Linux Access), Direct Register Access			
<sup>1</sup> See <a href="#">Mounting the heat sink</a> on page 162. <sup>2</sup> Output by <b>Device Temperature</b> <sup>3</sup> Ensure that the sensor is operated in the temperature range specified by the manufacturer. For any questions, please visit <a href="http://www.alliedvision.com/en/support">www.alliedvision.com/en/support</a> . <sup>4</sup> Temperature values must be observed for the housing <b>and</b> for the cooling areas.				

Table 20: Alvium 1500 C-120m/c specifications (sheet 2 of 2)



### Absolute QE

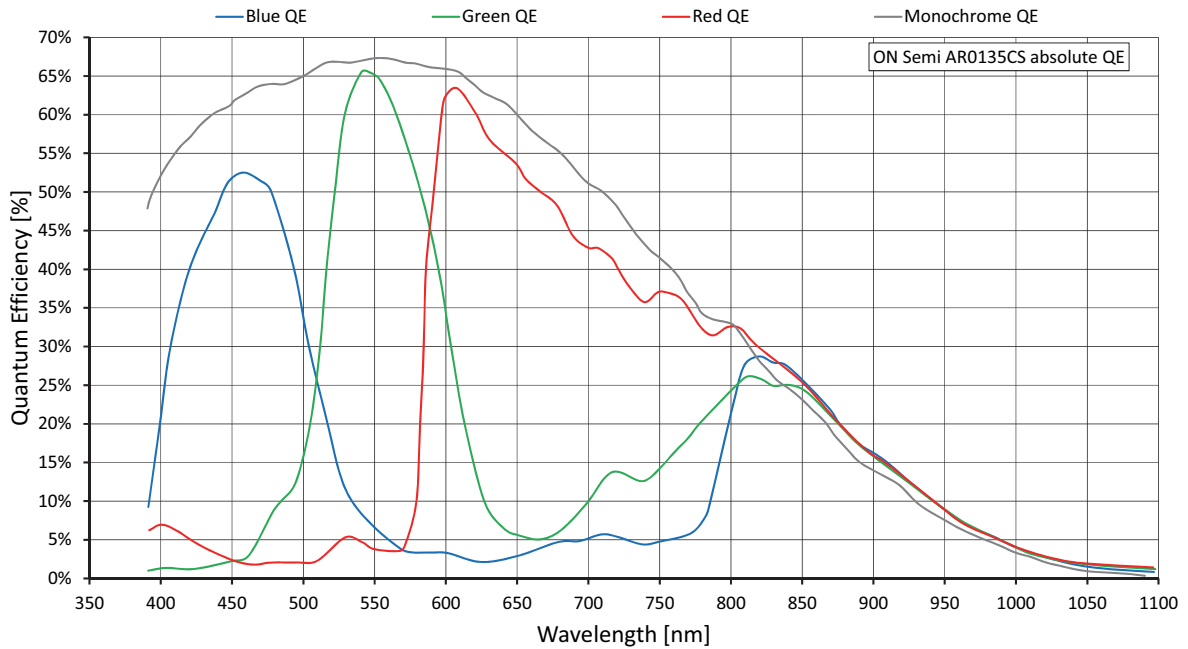

Figure 7: Alvium 1500 C-120m/c (ON Semi AR0135CS) absolute QE

### Spectral response

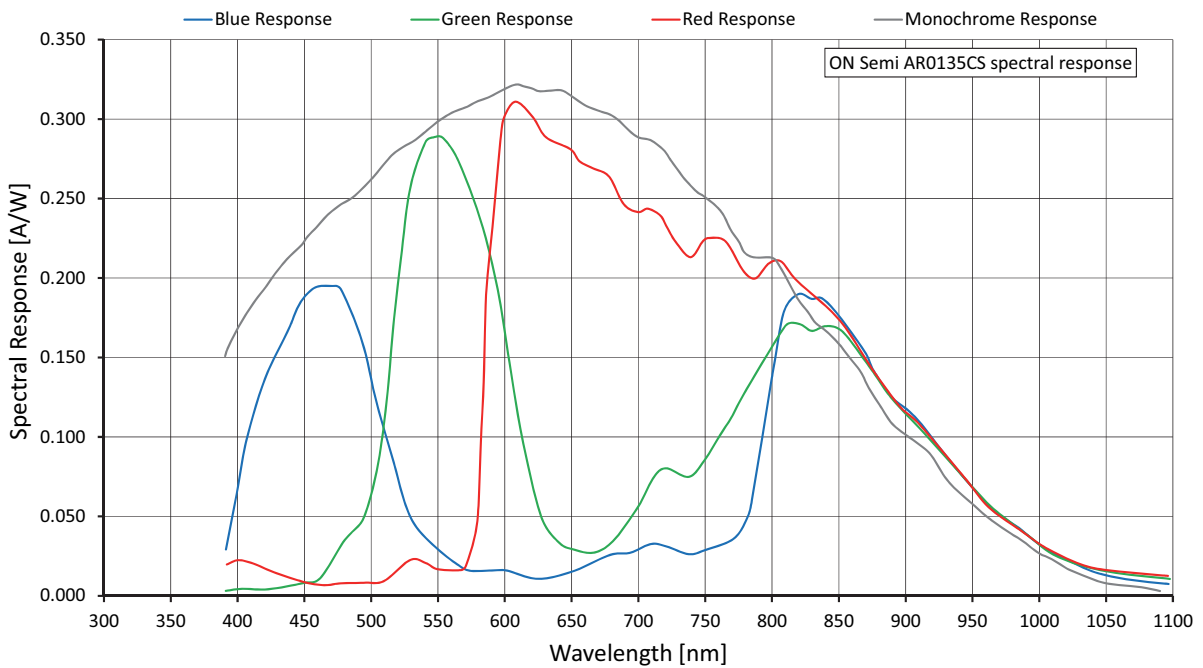

Figure 8: Alvium 1500 C-120m/c (ON Semi AR0135CS) spectral response

## Frame rates with Cropping

Values were calculated for **typical operation** defined in [Frame rates with Cropping/ROI frame rates](#) on page 49.

Frame rates at maximum bandwidth calculates for 1.051 Gbps per lane. To reach the maximum frame rate available for typical operation, the bandwidth for image traffic is at 1 lane with 1.051 Gbps. Increasing the CSI-2 Lane Count value does not increase frame rates.

Image format	Width [pixels]	Height [pixels]	ROI area [pixels]	Frame rate [fps]		
				4-lane	2-lane	1-lane
				4.204 Gbps	2.102 Gbps	1.051 Gbps
Full resolution	1,280	960	1,228,800	52		
HD 720	1,280	720	921,600	69		
XGA	1,024	768	786,432	65		
SVGA	800	600	480,000	81		
VGA	640	480	307,200	100		
QVGA	320	240	76,800	160		
QQVGA	160	120	19,200	160		
Maximum × half	1,280	480	614,400	100		
Maximum × minimum	1,280	16	20,480	160		
Minimum × maximum	16	960	15,360	52		
Minimum × minimum	16	16	256	160		

Table 21: Alvium 1500 C-120m/c ROI frame rates at maximum bandwidth

## Alvium 1500 C-210m/c

Feature	Specification	
	1500 C-210m (monochrome)	1500 C-210c (color)
Sensor model	ON Semiconductor AR0521SR	
Resolution	1928 (H) × 1088 (V); 2.1 MP	
Sensor type	CMOS	
Shutter type	Rolling shutter (RS)	
Sensor size	Type 1/3.6; 4.2 mm × 2.4 mm; 4.9 mm diagonal	
Pixel size	2.2 μm × 2.2 μm	
CRA	9 deg	
ADC	10-bit	
YUV color pixel formats	Not applicable	YUV422 8-bit (UYVY)
RGB color pixel formats	Default: RGB888 (RGB3)	
RAW pixel formats	RAW8 (GREY), RAW10 (Y10)	
Maximum image bit depth	10-bit	
Maximum frame rate	119 fps <sup>1</sup> , using 2 to 4 lanes	
Exposure time	8 μs to 0.48 s, (2 to 4 lanes), 15 μs to 0.96 s, (1 lane)	
Image buffer (RAM)	256 KB	
Non-volatile memory (Flash)	1024 KB	
Gain	0 dB to 24 dB; 0.1 dB increments	
GPIOs	2 programmable GPIOs As direct inputs (push-pull): 0 to 5.5 VDC As direct outputs (push-pull): 0 to 3.3 VDC at 12 mA	
Power requirements	Power over MIPI CSI-2	
Power consumption (typical, at 5 VDC)	1.9 W	

<sup>1</sup>In triggered mode: 59 fps

Table 22: Alvium 1500 C-210m/c specifications (sheet 1 of 2)

Feature	Specification			
	1500 C-210m/c			
Operating temperature	Hardware option	Housing	Cooling areas <sup>2</sup>	Mainboard <sup>3</sup>
	Bare board <sup>4</sup>	Not applicable	+5 °C to +85 °C	+5 °C to +85 °C
	Open housing <sup>5</sup>	+5 °C to +65 °C		
Relative humidity	0% to 80% (non-condensing)			
Digital interface	MIPI CSI-2 D-PHY V1.1; 1, 2, or 4 lanes; maximum 1.125 Gbps per lane			
Camera controls	V4L2 controls (Video4Linux Access), Direct Register Access			

<sup>2</sup>See [Mounting the heat sink](#) on page 162.

<sup>3</sup>Output by **Device Temperature**

<sup>4</sup>Ensure that the sensor is operated in the temperature range specified by the manufacturer. For any questions, please visit [www.alliedvision.com/en/support](http://www.alliedvision.com/en/support).

<sup>5</sup>Temperature values must be observed for the housing **and** for the cooling areas.

Table 22: Alvium 1500 C-210m/c specifications (sheet 2 of 2)

### Absolute QE

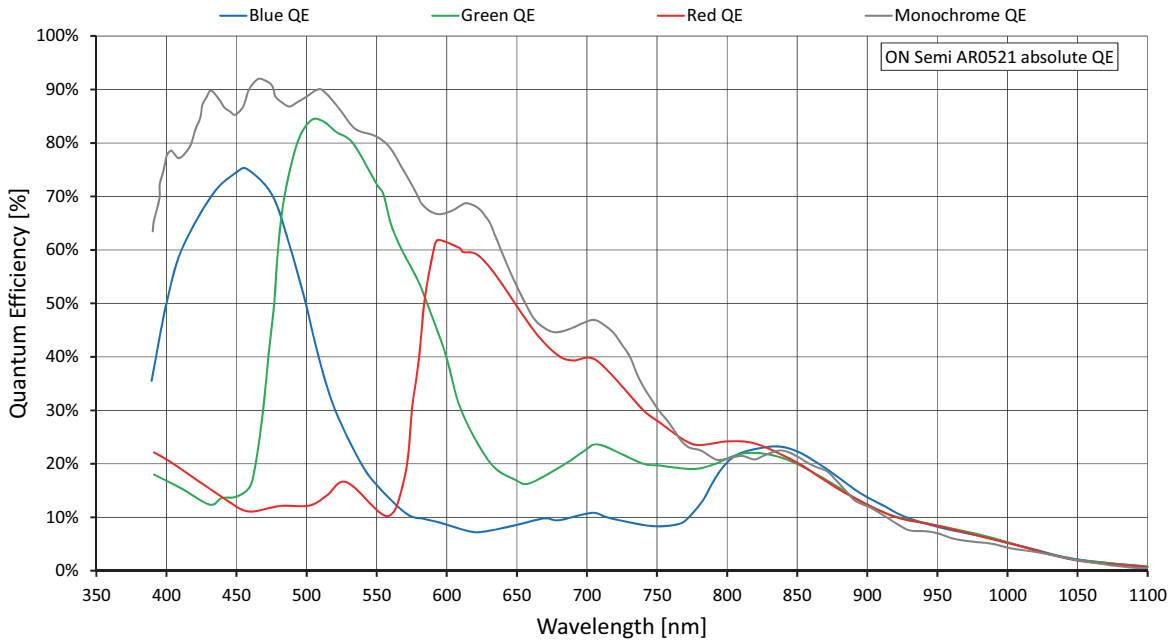

Figure 9: Alvium 1500 C-210m/c (ON Semi AR0521HD) absolute QE

### Spectral response

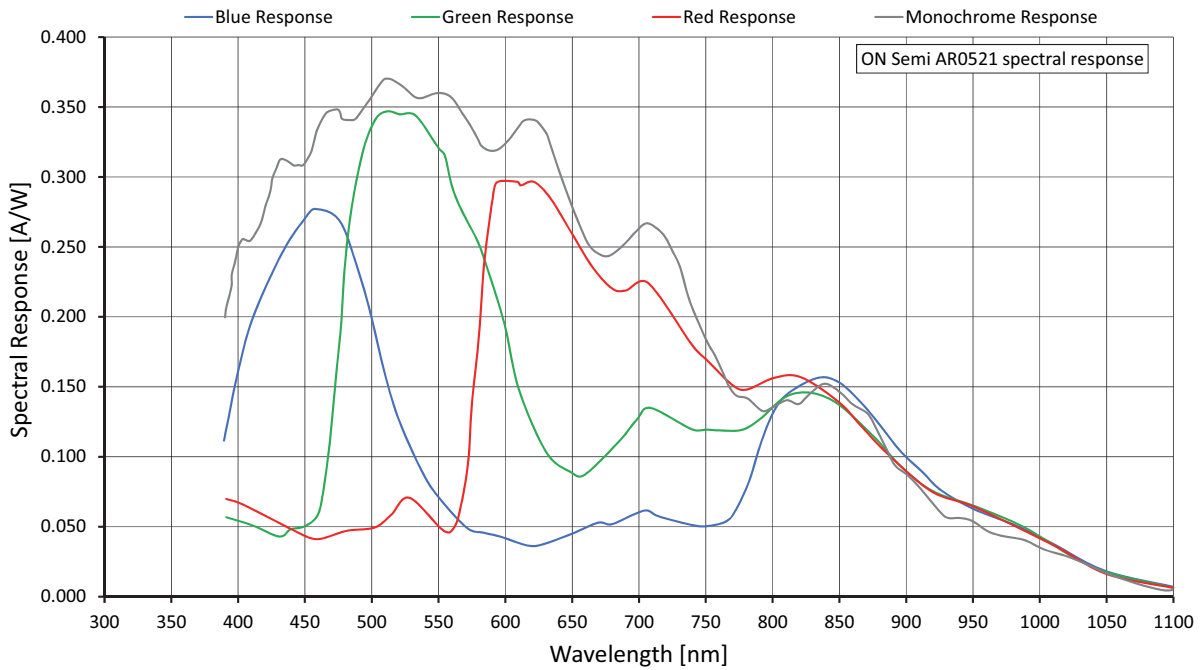

Figure 10: Alvium 1500 C-210m/c (ON Semi AR0521HD) spectral response

## Frame rates with Cropping

Values were calculated for **typical operation** defined in [Frame rates with Cropping/ROI frame rates](#) on page 49.

Frame rates at maximum bandwidth calculates for 1.051 Gbps per lane. To reach the maximum frame rate available for typical operation, the bandwidth for image traffic is at 2 lanes with 2.102 Gbps. Increasing the CSI-2 Lane Count value does not increase frame rates.

Image format	Width [pixels]	Height [pixels]	ROI area [pixels]	Frame rate [fps]		
				4-lane	2-lane	1-lane
				4.204 Gbps	2.102 Gbps	1.051 Gbps
Full resolution	1,928	1,088	2,097,664	119		60
Full HD	1,920	1,080	2,073,600	120		60
WXGA+ <sup>1</sup>	1,440	904 <sup>1</sup>	1,301,760	143		96
SXGA	1,280	1,024	1,310,720	127		96
HD 720	1,280	720	921,600	177		134
XGA	1,024	768	786,432	167		158
SVGA	800	600	480,000	212		
VGA	640	480	307,200	261		
QVGA	320	240	76,800	488		
QQVGA	160	120	19,200	856		
Maximum × half	1,928	544	1,048,832	229		116
Maximum × minimum	1,928	16	30,848	2,062		1,154
Minimum × maximum	16	1,088	17,408	120		
Minimum × minimum	16	16	256	2,474		

<sup>1</sup> Instead of 1,440 × 900

Due to increments, some resolutions are not available. In this case, frame rates were calculated for the next available resolution.

Table 23: Alvium 1500 C-210m/c ROI frame rates at maximum bandwidth



### Values in triggered mode

When rolling shutter cameras are operated in triggered mode, the values for maximum frame rate reached in free run mode are cut in half.

## Alvium 1500 C-500m/c

Feature	Specification	
	1500 C-500m (monochrome)	1500 C-500c (color)
Sensor model	ON Semiconductor AR0521SR	
Resolution	2592 (H) × 1944 (V); 5.0 MP	
Sensor type	CMOS	
Shutter type	Rolling shutter (RS)	
Sensor size	Type 1/2.5; 5.7 mm × 4.3 mm; 7.1 mm diagonal	
Pixel size	2.2 μm × 2.2 μm	
CRA	9 deg	
ADC	10-bit	
YUV color pixel formats	Not applicable	YUV422 8-bit (UYVY)
RGB color pixel formats	Default: RGB888 (RGB3)	
RAW pixel formats	RAW8 (GREY), RAW10 (Y10)	
Maximum image bit depth	10-bit	
Maximum frame rate	68 fps <sup>1</sup> , using 4 lanes	
Exposure time	8 μs to 0.48 s (4 lanes), 10 μs to 0.64 s (2 lanes), 20 μs to 1.2 s (1 lane)	
Image buffer (RAM)	256 KB	
Non-volatile memory (Flash)	1024 KB	
Gain	0 dB to 24 dB; 0.1 dB increments	
GPIOs	2 programmable GPIOs As direct inputs (push-pull): 0 to 5.5 VDC As direct outputs (push-pull): 0 to 3.3 VDC at 12 mA	
Power requirements	Power over MIPI CSI-2	
Power consumption (typical, at 5 VDC)	1.9 W	

<sup>1</sup>In triggered mode: 34 fps

Table 24: Alvium 1500 C-500m/c specifications (sheet 1 of 2)

Feature	Specification			
	1500 C-500m/c			
Operating temperature	Hardware option	Housing	Cooling areas <sup>2</sup>	Mainboard <sup>3</sup>
	Bare board <sup>4</sup>	Not applicable	+5 °C to +85 °C	+5 °C to +85 °C
	Open housing <sup>5</sup>	+5 °C to +65 °C		
Relative humidity	0% to 80% (non-condensing)			
Digital interface	MIPI CSI-2 D-PHY V1.1; 1, 2, or 4 lanes; maximum 1.125 Gbps per lane			
Camera controls	V4L2 controls (Video4Linux Access), Direct Register Access			

<sup>2</sup>See [Mounting the heat sink](#) on page 162.

<sup>3</sup>Output by **Device Temperature**

<sup>4</sup>Ensure that the sensor is operated in the temperature range specified by the manufacturer. For any questions, please visit [www.alliedvision.com/en/support](http://www.alliedvision.com/en/support).

<sup>5</sup>Temperature values must be observed for the housing **and** for the cooling areas.

Table 24: Alvium 1500 C-500m/c specifications (sheet 2 of 2)



### Absolute QE

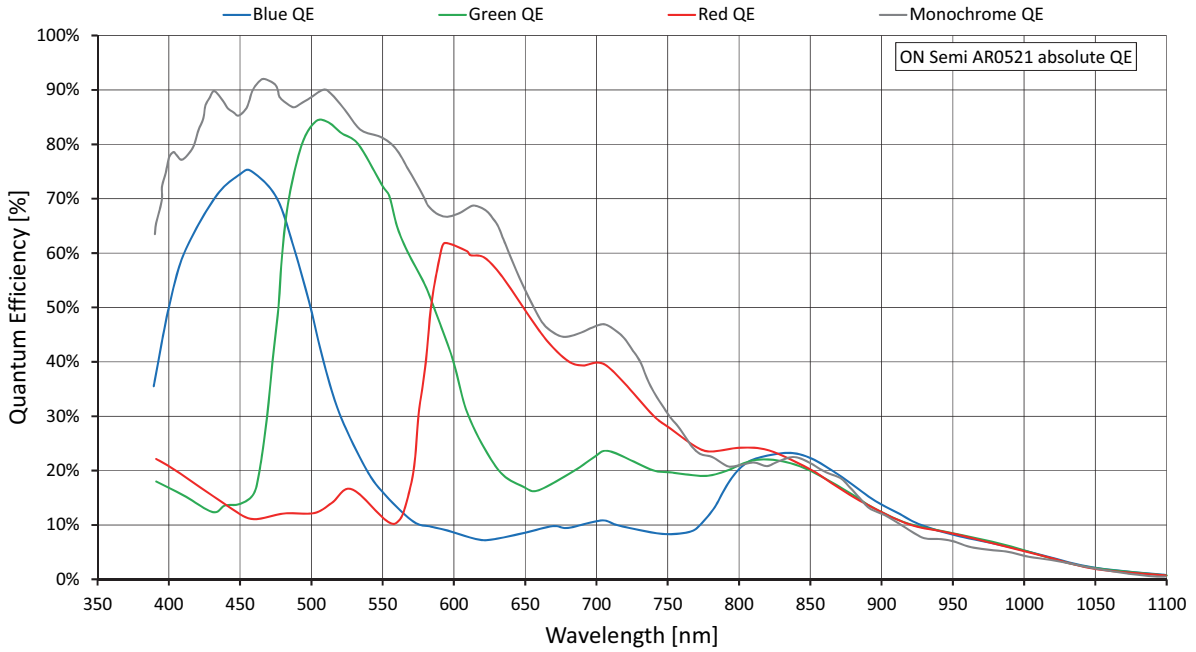

Figure 11: Alvium 1500 C-500m/c (ON Semi AR0521SR) absolute QE

### Spectral response

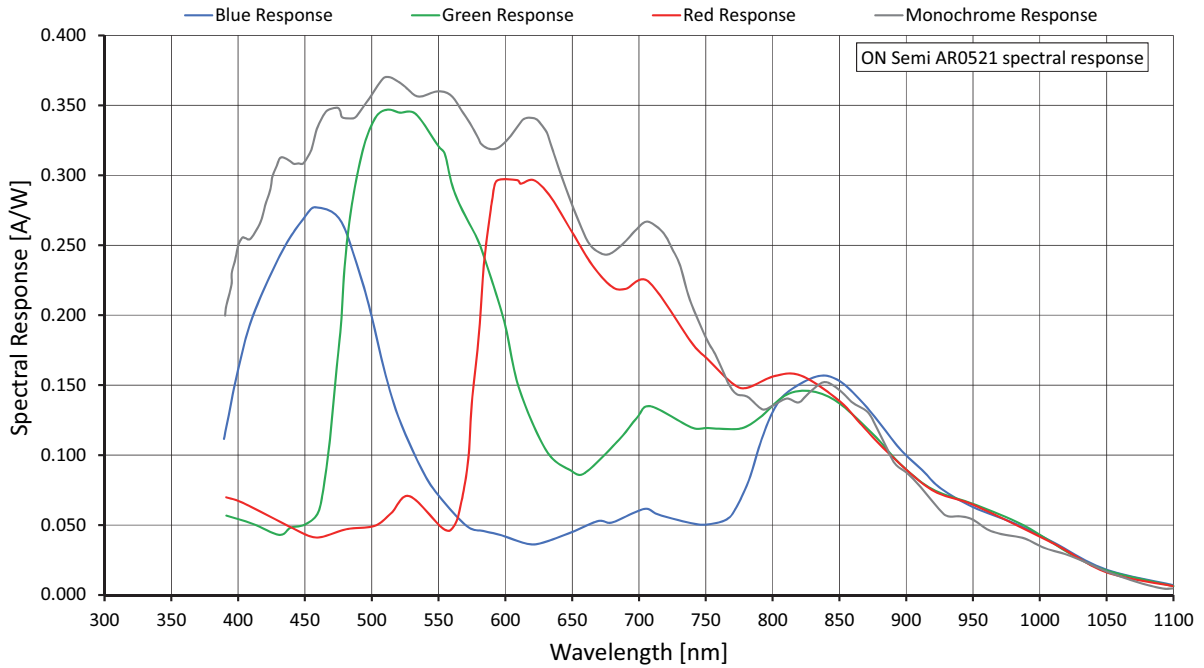

Figure 12: Alvium 1500 C-500m/c (ON Semi AR0521SR) spectral response

## Frame rates with Cropping

Values were calculated for **typical operation** defined in [Frame rates with Cropping/ROI frame rates](#) on page 49.

Frame rates at maximum bandwidth calculates for 1.051 Gbps per lane. To reach the maximum frame rate available for typical operation, the bandwidth for image traffic is at 4 lanes with 4.204 Gbps.

Image format	Width [pixels]	Height [pixels]	ROI area [pixels]	Frame rate [fps]		
				4-lane	2-lane	1-lane
				4.204 Gbps	2.102 Gbps	1.051 Gbps
Full resolution	2,592	1,944	5,038,848	68	50	25
WQHD	2,560	1,440	3,686,400	91	68	34
QXGA	2,048	1,536	3,145,728	85	80	40
Full HD	1,920	1,080	2,073,600	120		60
UXGA	1,600	1,200	1,920,000	109		66
WXGA+ <sup>1</sup>	1,440	904 <sup>1</sup>	1,301,760	143		96
SXGA	1,280	1,024	1,310,720	127		96
HD 720	1,280	720	921,600	177		134
XGA	1,024	768	786,432	167		158
SVGA	800	600	480,000	212		
VGA	640	480	307,200	261		
QVGA	320	240	76,800	488		
QQVGA	160	120	19,200	856		
Maximum × half <sup>2</sup>	2,592	976 <sup>2</sup>	2,529,792	132	98	49
Maximum × minimum	2,592	16	41,472	1,917	1,535	858
Minimum × maximum	16	1,944	31,104	68		
Minimum × minimum	16	16	256	2,474		

<sup>1</sup> Instead of 1,440 × 900  
<sup>2</sup> Instead of 2,592 × 972  
 Due to increments, some resolutions are not available. In this case, frame rates were calculated for the next available resolution.

Table 25: Alvium 1500 C-500m/c ROI frame rates at maximum bandwidth



### Values in triggered mode

When rolling shutter cameras are operated in triggered mode, the values for maximum frame rate reached in free run mode are cut in half.

## Alvium 1500 C-501m/c NIR

Feature	Specification	
	1500 C-501m NIR (monochrome)	1500 C-501c NIR (color)
Sensor model	ON Semiconductor AR0522	
Resolution	2592 (H) × 1944 (V); 5.0 MP	
Sensor type	CMOS	
Shutter type	Rolling shutter (RS)	
Sensor size	Type 1/2.5; 5.7 mm × 4.3 mm; 7.1 mm diagonal	
Pixel size	2.2 μm × 2.2 μm	
CRA	9 deg	
ADC	10-bit	
YUV color pixel formats	Not applicable	YUV422 8-bit (UYVY)
RGB color pixel formats	Default: RGB888 (RGB3)	
RAW pixel formats	RAW8 (GREY), RAW10 (Y10)	
Maximum image bit depth	10-bit	
Maximum frame rate	68 fps <sup>1</sup> , using 4 lanes	
Exposure time	8 μs to 0.48 s (4 lanes), 10 μs to 0.64 s (2 lanes), 20 μs to 1.2 s (1 lane)	
Image buffer (RAM)	256 KB	
Non-volatile memory (Flash)	1024 KB	
Gain	0 dB to 24 dB; 0.1 dB increments	
GPIOs	2 programmable GPIOs As direct inputs (push-pull): 0 to 5.5 VDC As direct outputs (push-pull): 0 to 3.3 VDC at 12 mA	
Power requirements	Power over MIPI CSI-2	
Power consumption (typical, at 5 VDC)	1.9 W	

<sup>1</sup>In triggered mode: 34 fps

Table 26: Alvium 1500 C-501m/c NIR specifications (sheet 1 of 2)

Feature	Specification			
	1500 C-501m/c NIR			
Operating temperature	Hardware option	Housing	Cooling areas <sup>2</sup>	Mainboard <sup>3</sup>
	Bare board <sup>4</sup>	Not applicable	+5 °C to +85 °C	+5 °C to +85 °C
	Open housing <sup>5</sup>	+5 °C to +65 °C		
Relative humidity	0% to 80% (non-condensing)			
Digital interface	MIPI CSI-2 D-PHY V1.1; 1, 2, or 4 lanes; maximum 1.125 Gbps per lane			
Camera controls	V4L2 controls (Video4Linux Access), Direct Register Access			

<sup>2</sup>See [Mounting the heat sink](#) on page 162.

<sup>3</sup>Output by **Device Temperature**

<sup>4</sup>Ensure that the sensor is operated in the temperature range specified by the manufacturer. For any questions, please visit [www.alliedvision.com/en/support](http://www.alliedvision.com/en/support).

<sup>5</sup>Temperature values must be observed for the housing **and** for the cooling areas.

Table 26: Alvium 1500 C-501m/c NIR specifications (sheet 2 of 2)

## Absolute QE

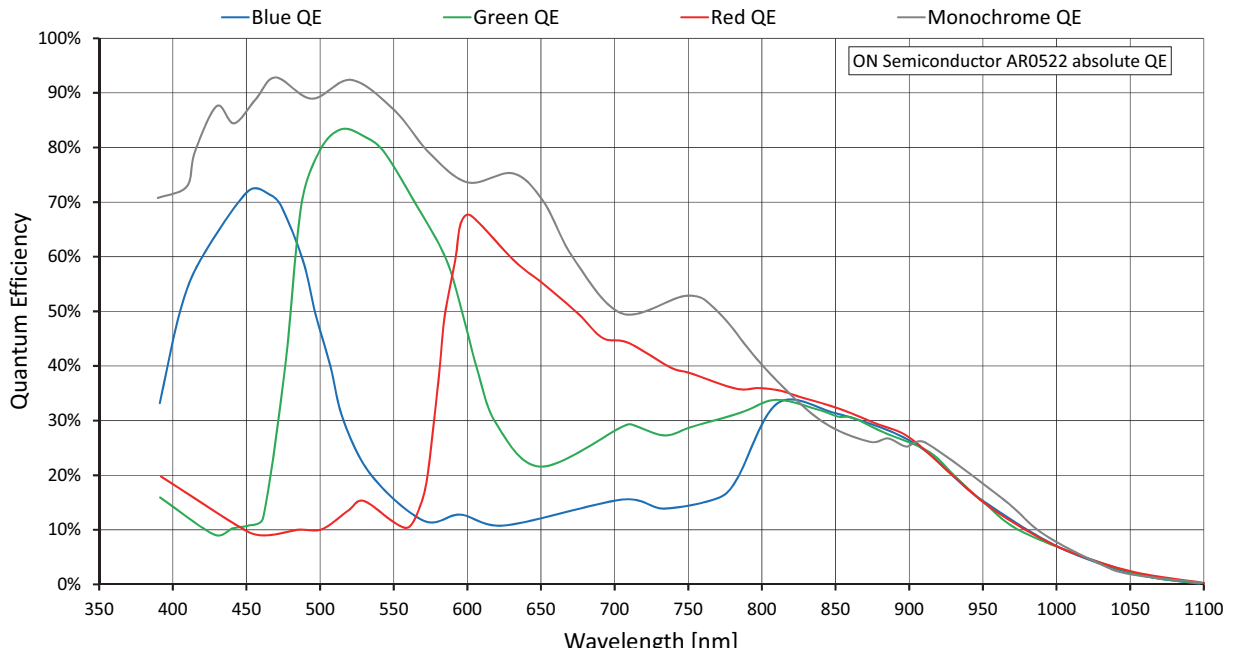

Figure 13: Alvium 1500 C-501m/c NIR (ON Semi AR0522) absolute QE

## Spectral response

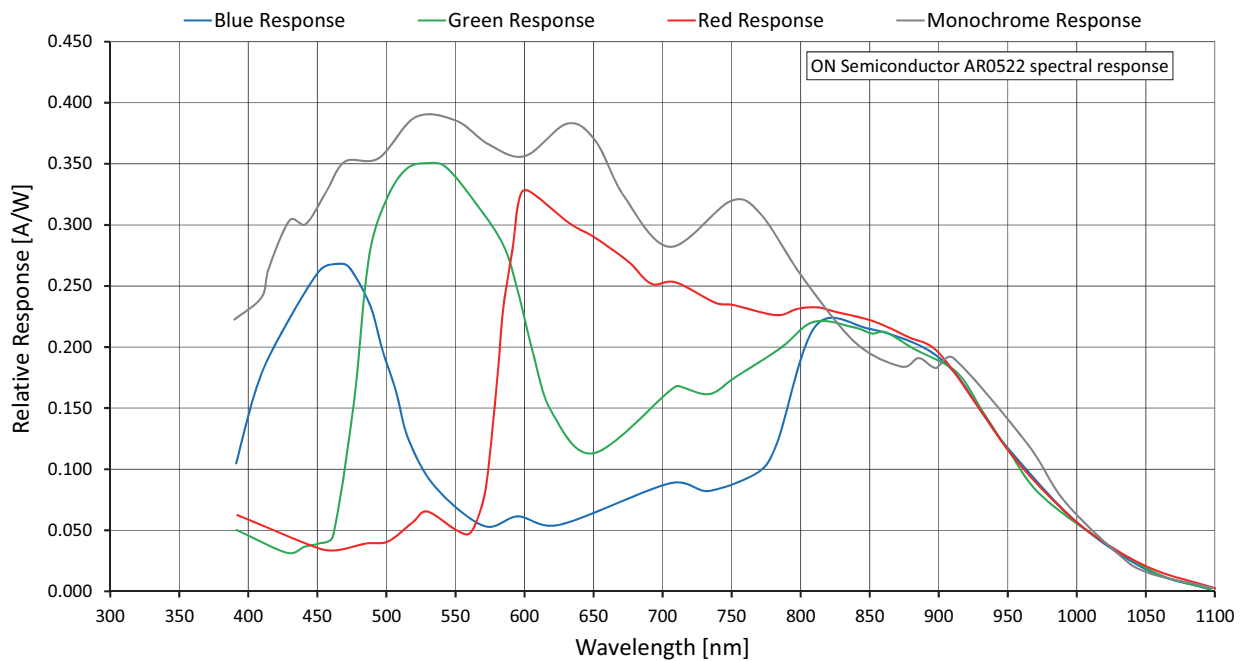

Figure 14: Alvium 1500 C-501m/c NIR (ON Semi AR0522) spectral response

## Frame rates with Cropping

Values were calculated for **typical operation** defined in [Frame rates with Cropping/ROI frame rates](#) on page 49.

Frame rates at maximum bandwidth calculates for 1.051 Gbps per lane. To reach the maximum frame rate available for typical operation, the bandwidth for image traffic is at 4 lanes with 4.204 Gbps.

Image format	Width [pixels]	Height [pixels]	ROI area [pixels]	Frame rate [fps]		
				4-lane	2-lane	1-lane
				4.204 Gbps	2.102 Gbps	1.051 Gbps
Full resolution	2,592	1,944	5,038,848	68	50	25
WQHD	2,560	1,440	3,686,400	91	68	34
QXGA	2,048	1,536	3,145,728	85	80	40
Full HD	1,920	1,080	2,073,600	120		60
UXGA	1,600	1,200	1,920,000	109		66
WXGA+ <sup>1</sup>	1,440	904 <sup>1</sup>	1,301,760	143		96
SXGA	1,280	1,024	1,310,720	127		96
HD 720	1,280	720	921,600	177		134
XGA	1,024	768	786,432	167		158
SVGA	800	600	480,000	212		
VGA	640	480	307,200	261		
QVGA	320	240	76,800	488		
QQVGA	160	120	19,200	856		
Maximum × half <sup>2</sup>	2,592	976 <sup>2</sup>	2,529,792,	132	98	49
Maximum × minimum	2,592	16	41,472	1,917	1,535	858
Minimum × maximum	16	1,944	31,104	68		
Minimum × minimum	16	16	256	2,474		

<sup>1</sup> Instead of 1440 × 900  
<sup>2</sup> Instead of 2,592 × 972  
 Due to increments, some resolutions are not available. In this case, frame rates were calculated for the next available resolution.

Table 27: Alvium 1500 C-501m/c NIR ROI frame rates at maximum bandwidth



### Values in triggered mode

When rolling shutter cameras are operated in triggered mode, the values for maximum frame rate reached in free run mode are cut in half.

# Alvium 1800 C model specifications

## Alvium 1800 C-040m/c

Feature	Specification	
	1800 C-040m (monochrome)	1800 C-040c (color)
Sensor model	Sony IMX287	
Resolution	728 (H) × 544 (V); 0.4 MP	
Sensor type	CMOS	
Shutter type	Global shutter (GS)	
Sensor size	Type 1/2.9; 5 mm × 3.8 mm; 6.3 mm diagonal	
Pixel size	6.9 μm × 6.9 μm	
CRA	0 deg	
ADC	12-bit	
YUV color pixel formats	Not applicable	YUV422 8-bit (UYVY)
RGB color pixel formats	Default: RGB888 (RGB3)	
RAW pixel formats	RAW8 (GREY), RAW10 (Y10), RAW12 (Y12)	
Maximum image bit depth	12-bit	
Maximum frame rate	289 fps, using 2 to 4 lanes	
Exposure time	177 μs to 10 s (2 to 4 lanes), 176 μs to 10 s (1 lane)	
Image buffer (RAM)	256 KB	
Non-volatile memory (Flash)	1024 KB	
Gain	0 dB to 24 dB; 0.1 dB increments	
GPIOs	2 programmable GPIOs As direct inputs (push-pull): 0 to 5.5 VDC As direct outputs (push-pull): 0 to 3.3 VDC at 12 mA	
Power requirements	Power over MIPI CSI-2	
Power consumption (typical, at 5 VDC)	1.7 W	

Table 28: Alvium 1800 C-040m/c specifications (sheet 1 of 2)

Feature	Specification			
	1800 C-040m/c			
Operating temperature	<b>Hardware option</b>	<b>Housing</b>	<b>Cooling areas<sup>1</sup></b>	<b>Mainboard<sup>2</sup></b>
	Bare board <sup>3</sup>	Not applicable	+5 °C to +85 °C	+5 °C to +85 °C
Open housing <sup>4</sup>	+5 °C to +65 °C			
Relative humidity	0% to 80% (non-condensing)			
Digital interface	MIPI CSI-2 D-PHY V1.1; 1, 2, or 4 lanes; maximum 1.125 Gbps per lane			
Camera controls	V4L2 controls (Video4Linux Access), Direct Register Access			
<sup>1</sup> See <a href="#">Mounting the heat sink</a> on page 162. <sup>2</sup> Output by <b>Device Temperature</b> <sup>3</sup> Ensure that the sensor is operated in the temperature range specified by the manufacturer. For any questions, please visit <a href="http://www.alliedvision.com/en/support">www.alliedvision.com/en/support</a> . <sup>4</sup> Temperature values must be observed for the housing <b>and</b> for the cooling areas.				

Table 28: Alvium 1800 C-040m/c specifications (sheet 2 of 2)



### Absolute QE

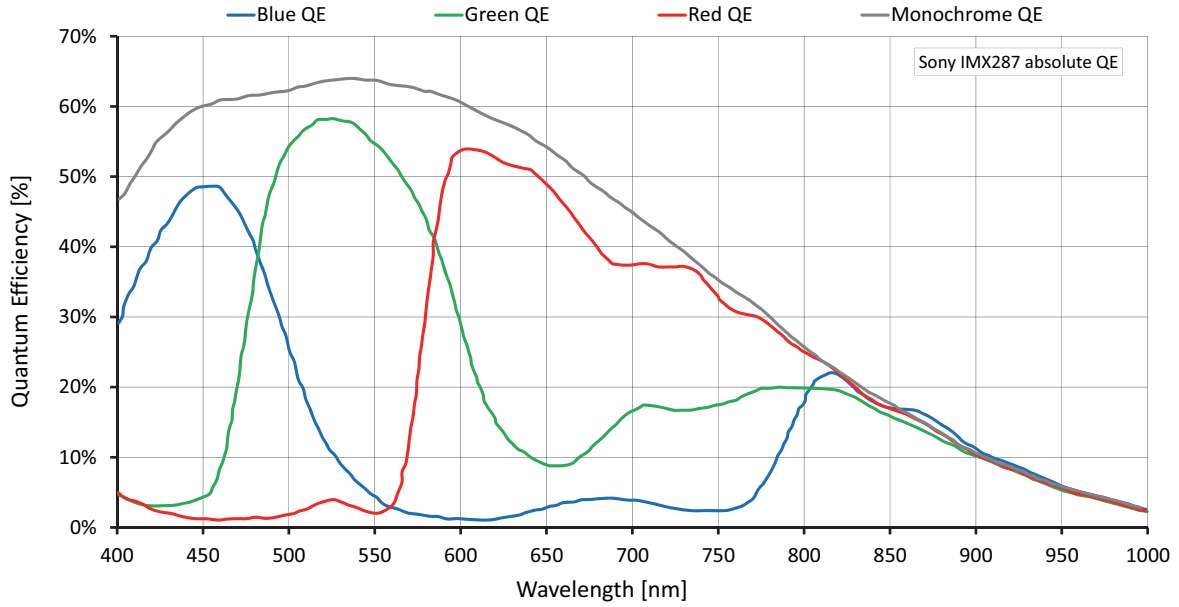

Figure 15: Alvium 1800 C-040m/c (Sony IMX287) absolute QE

### Spectral response

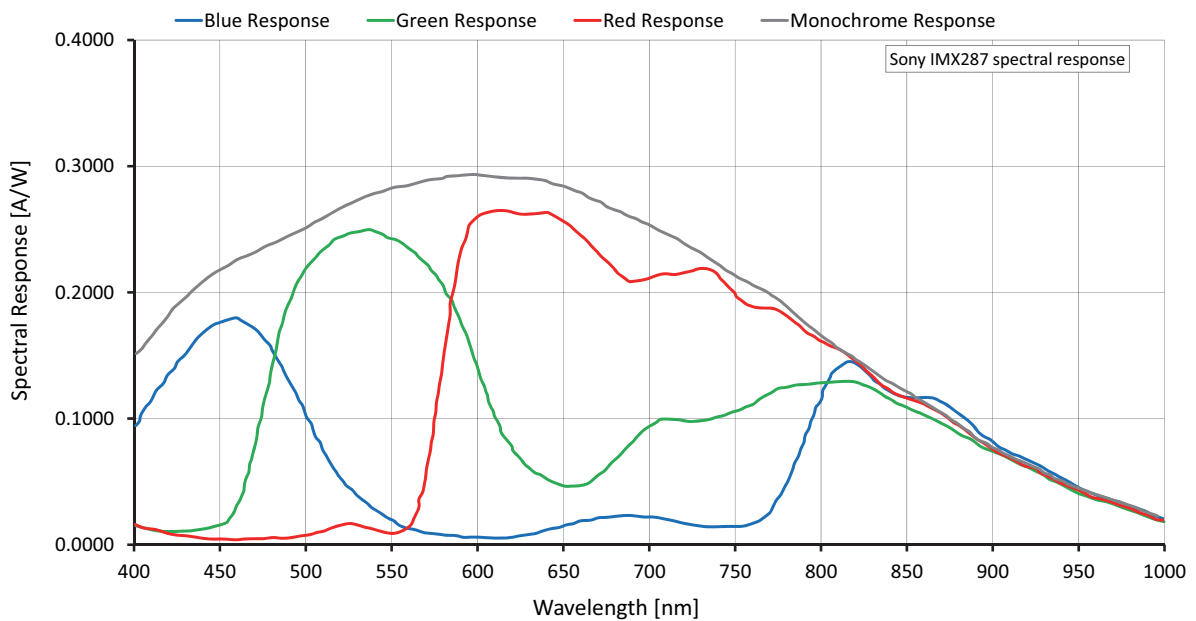

Figure 16: Alvium 1800 C-040m/c (Sony IMX287) spectral response

## Frame rates with Cropping

Values were calculated for **typical operation** defined in [Frame rates with Cropping/ROI frame rates](#) on page 49.

Frame rates at maximum bandwidth calculates for 1.051 Gbps per lane. To reach the maximum frame rate available for typical operation, the bandwidth for image traffic is at 2 lanes with 2.102 Gbps. Increasing the CSI-2 Lane Count value does not increase frame rates.

Image format	Width [pixels]	Height [pixels]	ROI area [pixels]	Frame rate [fps]		
				4-lane	2-lane	1-lane
				4.204 Gbps	2.102 Gbps	1.051 Gbps
Full resolution	728	544	396,032	289		281
VGA	640	480	307,200	322		
HVGA	480	320	153,600	450		
QVGA	320	240	76,800	564		
HQVGA	240	160	38,400		750	
QQVGA	160	120	19,200		896	
Maximum × half	728	272	198,016	503		491
Maximum × minimum	728	16	11,648	1,663		1,645
Minimum × maximum	16	544	8,704	293		
Minimum × minimum	16	16	256	1,810		

Table 29: Alvium 1800 C-040m/c ROI frame rates at maximum bandwidth

## Alvium 1800 C-158m/c

Feature	Specification	
	1800 C-158m (monochrome)	1800 C-158c (color)
Sensor model	Sony IMX273	
Resolution	1456 (H) × 1088 (V); 1.6 MP	
Sensor type	CMOS	
Shutter type	Global shutter (GS)	
Sensor size	Type 1/2.9; 5 mm × 3.8 mm; 6.3 mm diagonal	
Pixel size	3.45 μm × 3.45 μm	
CRA	0 deg	
ADC	12-bit	
YUV color pixel formats	Not applicable	YUV422 8-bit (UYVY)
RGB color pixel formats	Default: RGB888 (RGB3)	
RAW pixel formats	RAW8 (GREY), RAW10 (Y10), RAW12 (Y12)	
Maximum image bit depth	12-bit	
Maximum frame rate	153 fps, using 4 lanes	
Exposure time	177 μs to 10 s (4 lanes), 176 μs to 10 s (2 lanes), 171 μs to 10 s (1 lane)	
Image buffer (RAM)	256 KB	
Non-volatile memory (Flash)	1024 KB	
Gain	0 dB to 24 dB; 0.1 dB increments	
GPIOs	2 programmable GPIOs As direct inputs (push-pull): 0 to 5.5 VDC As direct outputs (push-pull): 0 to 3.3 VDC at 12 mA	
Power requirements	Power over MIPI CSI-2	
Power consumption (typical, at 5 VDC)	2.4 W	

Table 30: Alvium 1800 C-158m/c specifications (sheet 1 of 2)

Feature	Specification			
	1800 C-158m/c			
Operating temperature	Hardware option	Housing	Cooling areas <sup>1</sup>	Mainboard <sup>2</sup>
	Bare board <sup>3</sup>	Not applicable	+5 °C to +85 °C	+5 °C to +85 °C
	Open housing <sup>4</sup>	+5 °C to +65 °C		
Relative humidity	0% to 80% (non-condensing)			
Digital interface	MIPI CSI-2 D-PHY V1.1; 1, 2, or 4 lanes; maximum 1.125 Gbps per lane			
Camera controls	V4L2 controls (Video4Linux Access), Direct Register Access			
<sup>1</sup> See <a href="#">Mounting the heat sink</a> on page 162. <sup>2</sup> Output by <b>Device Temperature</b> <sup>3</sup> Ensure that the sensor is operated in the temperature range specified by the manufacturer. For any questions, please visit <a href="http://www.alliedvision.com/en/support">www.alliedvision.com/en/support</a> . <sup>4</sup> Temperature values must be observed for the housing <b>and</b> for the cooling areas.				

Table 30: Alvium 1800 C-158m/c specifications (sheet 2 of 2)

### Absolute QE

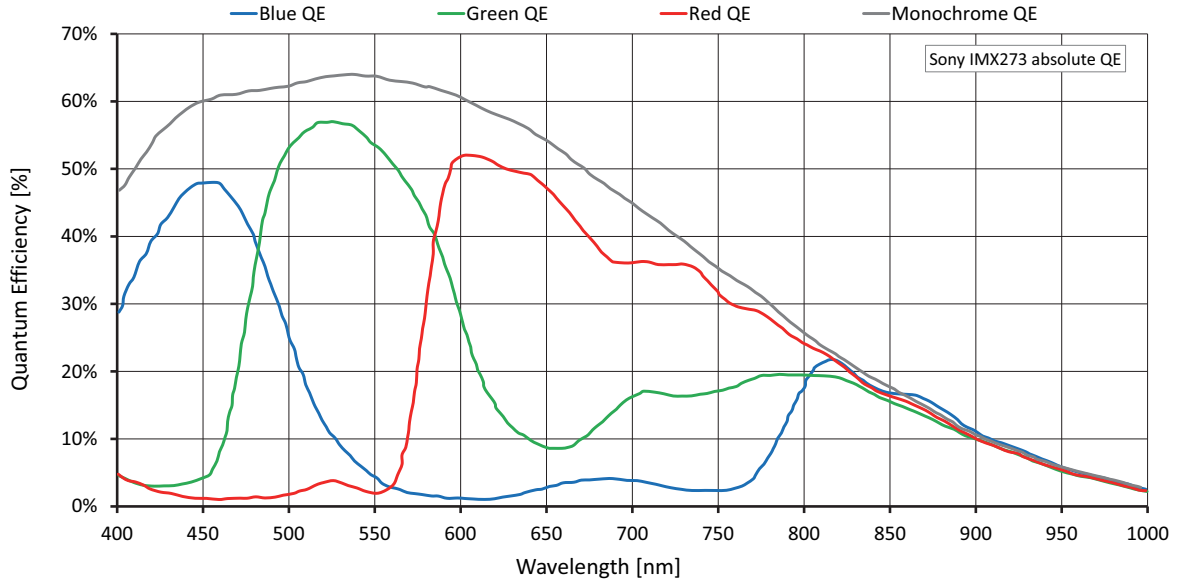

Figure 17: Alvium 1800 C-158m/c (Sony IMX273) absolute QE

### Spectral response

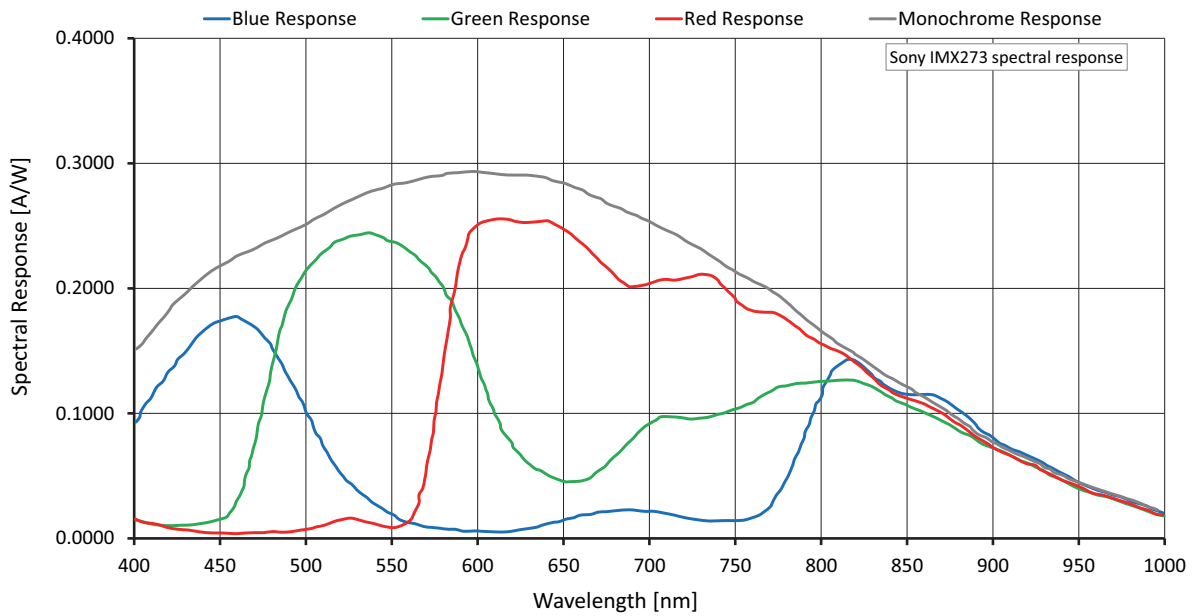

Figure 18: Alvium 1800 C-158m/c (Sony IMX273) spectral response

## Frame rates with Cropping

Values were calculated for **typical operation** defined in [Frame rates with Cropping/ROI frame rates](#) on page 49.

Frame rates at maximum bandwidth calculates for 1.051 Gbps per lane. To reach the maximum frame rate available for typical operation, the bandwidth for image traffic is at 4 lanes with 4.204 Gbps.

Image format	Width [pixels]	Height [pixels]	ROI area [pixels]	Frame rate [fps]		
				4-lane	2-lane	1-lane
				4.204 Gbps	2.102 Gbps	1.051 Gbps
Full resolution	1,456	1,088	1,584,128	153	149	76
WXGA <sup>1</sup>	1,440	904 <sup>1</sup>	1,301,760	181	178	92
SXGA	1,280	1,024	1,310,720	163		92
HD 720	1,280	720	921,600	222		127
XGA	1,024	768	786,432	211		149
SVGA	800	600	480,000	264		235
VGA	640	480	307,200	321		
QVGA	320	240	76,800	564		
QQVGA	160	120	19,200	896		
Maximum × half	1,456	544	792,064	281	273	143
Maximum × minimum	1,456	16	23,296	1,431	1,412	934
Minimum × maximum	16	1088	17,408	157		
Minimum × minimum	16	16	256	1,810		

<sup>1</sup> Instead of 1,440 × 900  
 Due to increments, some resolutions are not available. In this case, frame rates were calculated for the next available resolution.

Figure 19: Alvim 1800 C-158m/c ROI frame rates at maximum bandwidth

## Alvium 1800 C-240m/c

Feature	Specification	
	1800 C-240m (monochrome)	1800 C-240c (color)
Sensor model	Sony IMX392	
Resolution	1936 (H) x 1216 (V); 2.4 MP	
Sensor type	CMOS	
Shutter type	Global shutter (GS)	
Sensor size	Type 1/2.3; 6.7 mm x 4.2 mm; 7.9 mm diagonal	
Pixel size	3.45 $\mu\text{m}$ x 3.45 $\mu\text{m}$	
CRA	0 deg	
ADC	12-bit	
YUV color pixel formats	Not applicable	YUV422 8-bit (UYVY)
RGB color pixel formats	Default: RGB888 (RGB3)	
RAW pixel formats	RAW8 (GREY), RAW10 (Y10), RAW12 (Y12)	
Maximum image bit depth	12-bit	
Maximum frame rate	126 fps, using 4 lanes	
Exposure time	176 $\mu\text{s}$ to 10 s (4 lanes), 178 $\mu\text{s}$ to 10 s (2 lanes); 177 $\mu\text{s}$ to 10 s (1 lane)	
Image buffer (RAM)	256 KB	
Non-volatile memory (Flash)	1024 KB	
Gain	0 dB to 24 dB; 0.1 dB increments	
GPIOs	2 programmable GPIOs As direct inputs (push-pull): 0 to 5.5 VDC As direct outputs (push-pull): 0 to 3.3 VDC at 12 mA	
Power requirements	Power over MIPI CSI-2	
Power consumption (typical, at 5 VDC)	2.7 W	

Table 31: Alvium 1800 C-240m/c specifications (sheet 1 of 2)

Feature	Specification			
	1800 C-240m/c			
Operating temperature	Hardware option	Housing	Cooling areas <sup>1</sup>	Mainboard <sup>2</sup>
	Bare board <sup>3</sup>	Not applicable	+5 °C to +85 °C	+5 °C to +85 °C
	Open housing <sup>4</sup>	+5 °C to +65 °C		
Relative humidity	0% to 80% (non-condensing)			
Digital interface	MIPI CSI-2 D-PHY V1.1; 1, 2, or 4 lanes; maximum 1.125 Gbps per lane			
Camera controls	V4L2 controls (Video4Linux Access), Direct Register Access			
<sup>1</sup> See <a href="#">Mounting the heat sink</a> on page 162. <sup>2</sup> Output by <b>Device Temperature</b> <sup>3</sup> Ensure that the sensor is operated in the temperature range specified by the manufacturer. For any questions, please visit <a href="http://www.alliedvision.com/en/support">www.alliedvision.com/en/support</a> . <sup>4</sup> Temperature values must be observed for the housing <b>and</b> for the cooling areas.				

Table 31: Alvium 1800 C-240m/c specifications (sheet 2 of 2)



### Absolute QE

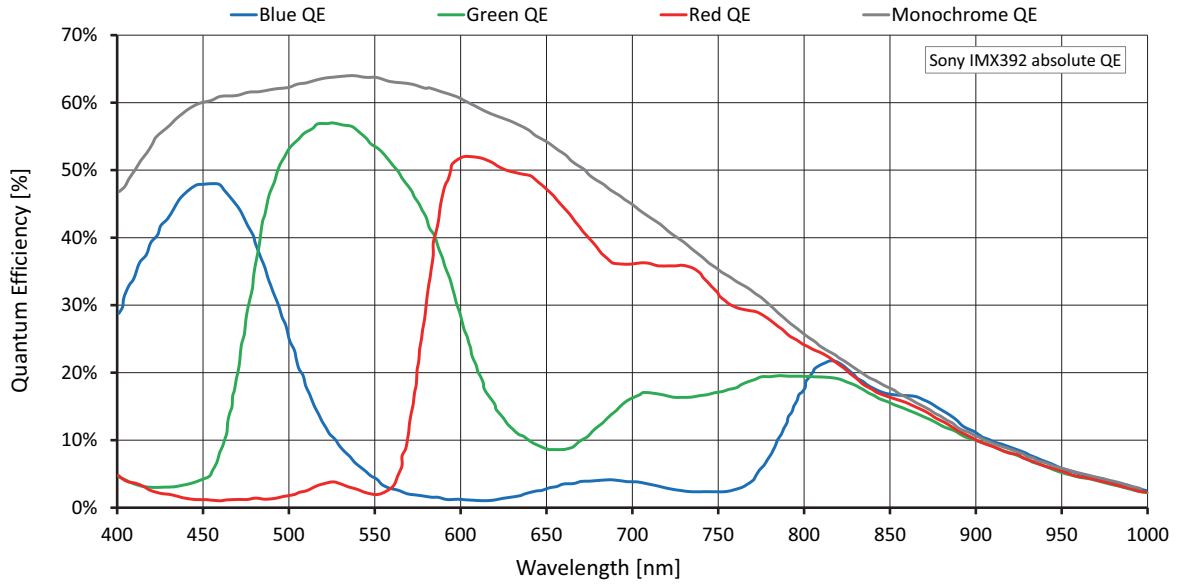

Figure 20: Alvim 1800 C-240m/c (Sony IMX392) absolute QE

### Spectral response

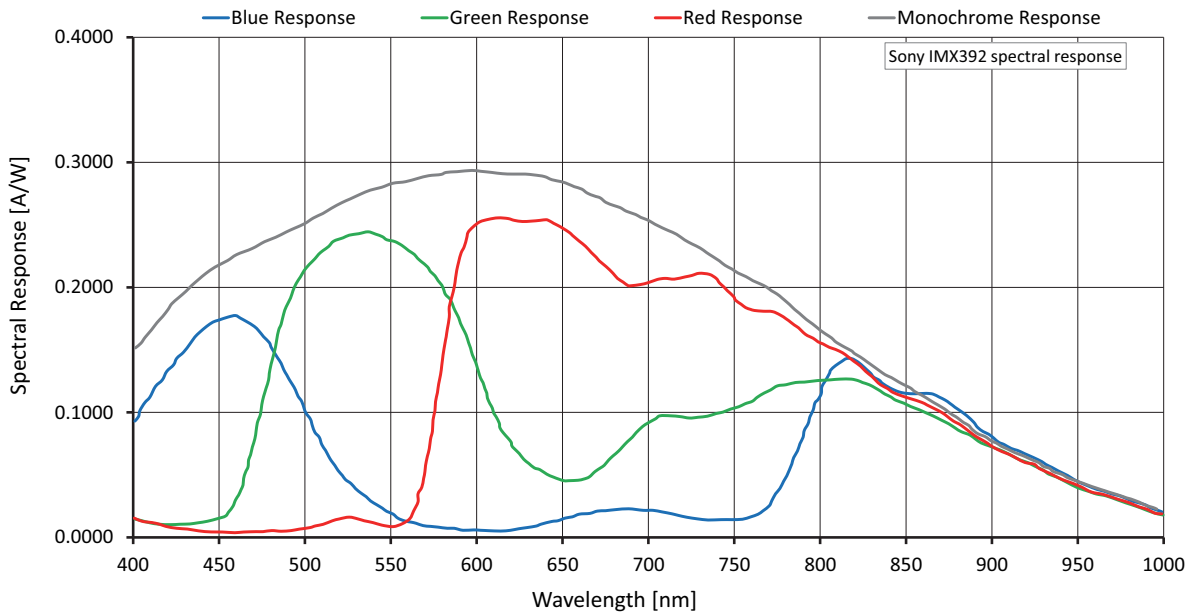

Figure 21: Alvim 1800 C-240m/c (Sony IMX392) spectral response

## Frame rates with Cropping

Values were calculated for **typical operation** defined in [Frame rates with Cropping/ROI frame rates](#) on page 49.

Frame rates at maximum bandwidth calculates for 1.051 Gbps per lane. To reach the maximum frame rate available for typical operation, the bandwidth for image traffic is at 4 lanes with 4.204 Gbps.

Image format	Width [pixels]	Height [pixels]	ROI area [pixels]	Frame rate [fps]		
				4-lane	2-lane	1-lane
				4.204 Gbps	2.102 Gbps	1.051 Gbps
Full resolution	1,936	1,216	2,354,176	126	102	52
Full HD	1,920	1,080	2,073,600	140	115	59
UXGA	1,600	1,200	1,920,000	128	125	64
WXGA <sup>1</sup>	1,440	904 <sup>1</sup>	1,301,760	166		93
SXGA	1,280	1,024	1,310,720	149		93
HD 720	1,280	720	921,600	204		128
XGA	1,024	768	786,432	194		150
SVGA	800	600	480,000	243		238
VGA	640	480	307,200	297		
QVGA	320	240	76,800	529		
QQVGA	160	120	19,200	862		
Maximum × half	1,936	608	1,177,088	233	191	99
Maximum × minimum	1,936	16	30,976	1,337	1,200	795
Minimum × maximum	16	1,216	19,456	129		
Minimum × minimum	16	16	256	1,858		

<sup>1</sup> Instead of 1,440 × 900  
 Due to increments, some resolutions are not available. In this case, frame rates were calculated for the next available resolution.

Table 32: Alvium 1800 C-240m/c ROI frame rates at maximum bandwidth

## Alvium 1800 C-319m/c

Feature	Specification	
	1800 C-319m (monochrome)	1800 C-319c (color)
Sensor model	Sony IMX265	
Resolution	2064 (H) × 1544 (V); 3.2 MP	
Sensor type	CMOS	
Shutter type	Global shutter (GS)	
Sensor size	Type 1/1.8; 7.1 mm × 5.3 mm; 8.9 mm diagonal	
Pixel size	3.45 μm × 3.45 μm	
CRA	0 deg	
ADC	12-bit	
YUV color pixel formats	Not applicable	YUV422 8-bit (UYVY)
RGB color pixel formats	Default: RGB888 (RGB3)	
RAW pixel formats	RAW8 (GREY), RAW10 (Y10), RAW12 (Y12)	
Maximum image bit depth	12-bit	
Maximum frame rate	53 fps, using 2 to 4 lanes	
Exposure time	175 μs to 10 s (2 to 4 lanes), 172 μs to 10 s (1 lane)	
Image buffer (RAM)	256 KB	
Non-volatile memory (Flash)	1024 KB	
Gain	0 dB to 24 dB; 0.1 dB increments	
GPIOs	2 programmable GPIOs As direct inputs (push-pull): 0 to 5.5 VDC As direct outputs (push-pull): 0 to 3.3 VDC at 12 mA	
Power requirements	Power over MIPI CSI-2	
Power consumption (typical, at 5 VDC)	1.9 W	

Table 33: Alvium 1800 C-319m/c specifications (sheet 1 of 2)

Feature	Specification			
	<b>1800 C-319m/c</b>			
<b>Operating temperature</b>	<b>Hardware option</b>	<b>Housing</b>	<b>Cooling areas<sup>1</sup></b>	<b>Mainboard<sup>2</sup></b>
	Bare board <sup>3</sup>	Not applicable	+5 °C to +85 °C	+5 °C to +85 °C
	Open housing <sup>4</sup>	+5 °C to +65 °C		
Relative humidity	0% to 80% (non-condensing)			
Digital interface	MIPI CSI-2 D-PHY V1.1; 1, 2, or 4 lanes; maximum 1.125 Gbps per lane			
Camera controls	V4L2 controls (Video4Linux Access), Direct Register Access			
<sup>1</sup> See <a href="#">Mounting the heat sink</a> on page 162. <sup>2</sup> Output by <b>Device Temperature</b> <sup>3</sup> Ensure that the sensor is operated in the temperature range specified by the manufacturer. For any questions, please visit <a href="http://www.alliedvision.com/en/support">www.alliedvision.com/en/support</a> . <sup>4</sup> Temperature values must be observed for the housing <b>and</b> for the cooling areas.				

Table 33: Alvium 1800 C-319m/c specifications (sheet 2 of 2)

### Absolute QE

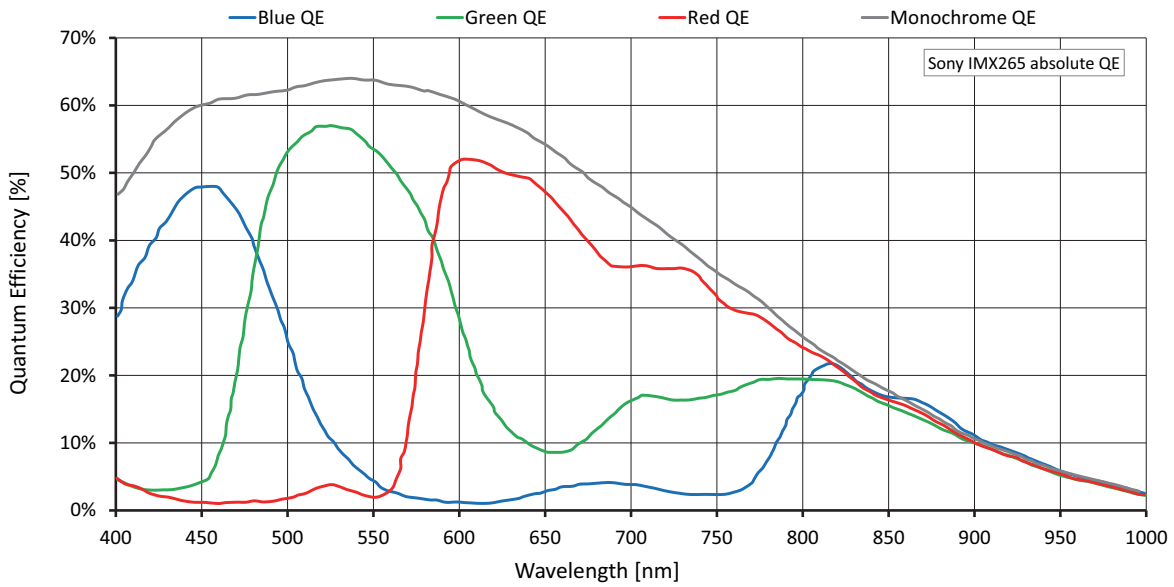

Figure 22: Alvium 1800 C-319m/c (Sony IMX265) absolute QE

### Spectral response

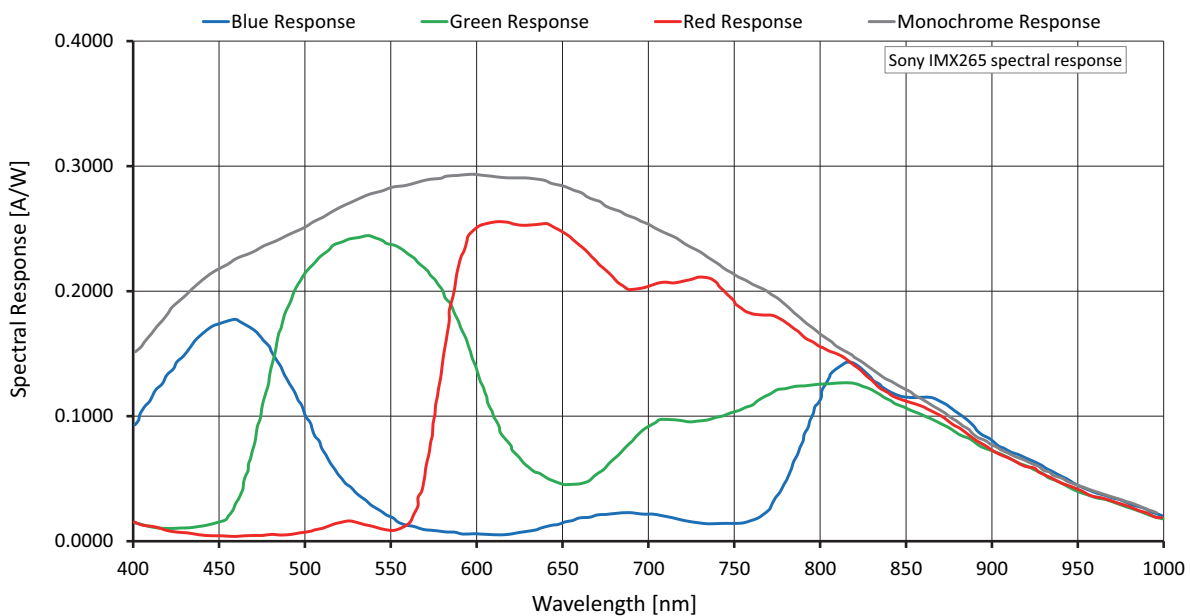

Figure 23: Alvium 1800 C-319m/c (Sony IMX265) spectral response

## Frame rates with Cropping

Values were calculated for **typical operation** defined in [Frame rates with Cropping/ROI frame rates](#) on page 49.

Frame rates at maximum bandwidth calculates for 1.051 Gbps per lane. To reach the maximum frame rate available for typical operation, the bandwidth for image traffic is at 2 lanes with 2.102 Gbps. Increasing the CSI-2 Lane Count value does not increase frame rates.

Image format	Width [pixels]	Height [pixels]	ROI area [pixels]	Frame rate [fps]		
				4-lane	2-lane	1-lane
				4.204 Gbps	2.102 Gbps	1.051 Gbps
Full resolution	2,064	1,544	3,186,816	53		39
QXGA	2,048	1,536	3,145,728	54		39
Full HD	1,920	1,080	2,073,600	75		59
UXGA	1,600	1,200	1,920,000	68		64
WXGA+ <sup>1</sup>	1,440	904 <sup>1</sup>	1,301,760		89	
SXGA	1,280	1,024	1,310,720		79	
HD 720	1,280	720	921,600		110	
XGA	1,024	768	786,432		104	
SVGA	800	600	480,000		131	
VGA	640	480	307,200		160	
QVGA	320	240	76,800		289	
QQVGA	160	120	19,200		484	
Maximum × half <sup>2</sup>	2,064	776 <sup>2</sup>	1,601,664	102		75
Maximum × minimum	2,064	16	33,024	937		755
Minimum × maximum	16	1,544	24,704		54	
Minimum × minimum	16	16	256		1,146	

<sup>1</sup>Instead of 1,440 × 900  
<sup>2</sup> Instead of 2,064 × 772  
 Due to increments, some resolutions are not available. In this case, frame rates were calculated for the next available resolution.

Table 34: Alvium 1800 C-319m/c ROI frame rates at maximum bandwidth

## Alvium 1800 C-507m/c

Feature	Specification	
	1800 C-507m (monochrome)	1800 C-507c (color)
Sensor model	Sony IMX264	
Resolution	2464 (H) × 2056 (V); 5.1 MP	
Sensor type	CMOS	
Shutter type	Global shutter (GS)	
Sensor size	Type 2/3; 8.5 mm × 7.1 mm; 11.1 mm diagonal	
Pixel size	3.45 μm × 3.45 μm	
CRA	0 deg	
ADC	12-bit	
YUV color pixel formats	Not applicable	YUV422 8-bit (UYVY)
RGB color pixel formats	Default: RGB888 (RGB3)	
RAW pixel formats	RAW8 (GREY), RAW10 (Y10), RAW12 (Y12)	
Maximum image bit depth	12-bit	
Maximum frame rate	34 fps, using 2 to 4 lanes	
Exposure time	176 μs to 10 s (2 to 4 lanes), 165 μs to 10 s (1 lane)	
Image buffer (RAM)	256 KB	
Non-volatile memory (Flash)	1024 KB	
Gain	0 dB to 24 dB; 0.1 dB increments	
GPIOs	2 programmable GPIOs As direct inputs (push-pull): 0 to 5.5 VDC As direct outputs (push-pull): 0 to 3.3 VDC at 12 mA	
Power requirements	Power over MIPI CSI-2	
Power consumption (typical, at 5 VDC)	1.9 W	

Table 35: Alvium 1800 C-507m/c specifications (sheet 1 of 2)

Feature	Specification			
	1800 C-507m/c			
Operating temperature	Hardware option	Housing	Cooling areas <sup>1</sup>	Mainboard <sup>2</sup>
	Bare board <sup>3</sup>	Not applicable	+5 °C to +85 °C	+5 °C to +85 °C
	Open housing <sup>4</sup>	+5 °C to +65 °C		
Relative humidity	0% to 80% (non-condensing)			
Digital interface	MIPI CSI-2 D-PHY V1.1; 1, 2, or 4 lanes; maximum 1.125 Gbps per lane			
Camera controls	V4L2 controls (Video4Linux Access), Direct Register Access			
<sup>1</sup> See <a href="#">Mounting the heat sink</a> on page 162. <sup>2</sup> Output by <b>Device Temperature</b> <sup>3</sup> Ensure that the sensor is operated in the temperature range specified by the manufacturer. For any questions, please visit <a href="http://www.alliedvision.com/en/support">www.alliedvision.com/en/support</a> . <sup>4</sup> Temperature values must be observed for the housing <b>and</b> for the cooling areas.				

Table 35: Alvium 1800 C-507m/c specifications (sheet 2 of 2)



### Absolute QE

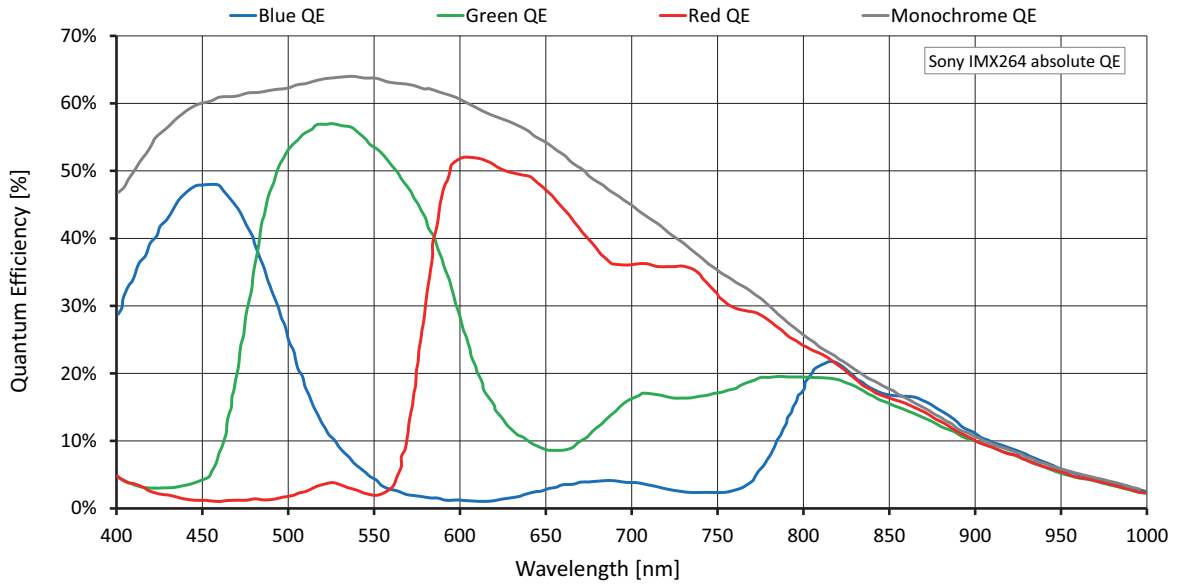

Figure 24: Alvium 1800 C-507m/c (Sony IMX264) absolute QE

### Spectral response

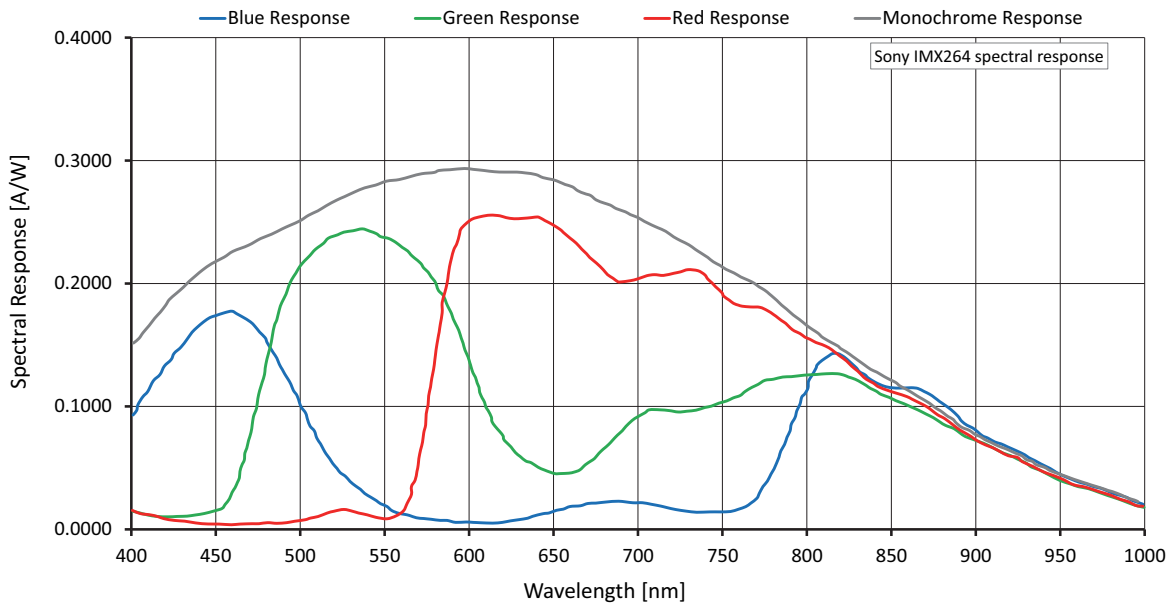

Figure 25: Alvium 1800 C-507m/c (Sony IMX264) spectral response

## Frame rates with Cropping

Values were calculated for **typical operation** defined in [Frame rates with Cropping/ROI frame rates](#) on page 49.

Frame rates at maximum bandwidth calculates for 1.051 Gbps per lane. To reach the maximum frame rate available for typical operation, the bandwidth for image traffic is at 2 lanes with 2.102 Gbps. Increasing the CSI-2 Lane Count value does not increase frame rates.

Image format	Width [pixels]	Height [pixels]	ROI area [pixels]	Frame rate [fps]		
				4-lane	2-lane	1-lane
				4.204 Gbps	2.102 Gbps	1.051 Gbps
Full resolution	2,464	2,056	5,065,984	34		25
QXGA	2,048	1,536	3,145,728	46		39
Full HD	1,920	1,080	2,073,600	64		59
UXGA	1,600	1,200	1,920,000		58	
WXGA+ <sup>1</sup>	1,440	904 <sup>1</sup>	1,301,760		76	
SXGA	1,280	1,024	1,310,720		67	
HD 720	1,280	720	921,600		94	
XGA	1,024	768	786,432		89	
SVGA	800	600	480,000		111	
VGA	640	480	307,200		136	
QVGA	320	240	76,800		248	
QQVGA	160	120	19,200		416	
Maximum × half <sup>2</sup>	2,464	1,032 <sup>2</sup>	2,542,848	66		48
Maximum × minimum	2,464	16	39,424	814		647
Minimum × maximum	16	2,056	32,896		35	
Minimum × minimum	16	16	256		1,001	

<sup>1</sup> Instead of 1,440 × 900  
<sup>2</sup> Instead of 2,464 × 1,028  
 Due to increments, some resolutions are not available. In this case, frame rates were calculated for the next available resolution.

Table 36: Alvim 1800 C-507m/c ROI frame rates at maximum bandwidth

## Alvium 1800 C-508m/c

Feature	Specification	
	1800 C-508m (monochrome)	1800 C-508c (color)
Sensor model	Sony IMX250LLR	Sony IMX250LQR
Resolution	2464 (H) x 2056 (V); 5.1 MP	
Sensor type	CMOS	
Shutter type	Global shutter (GS)	
Sensor size	Type 2/3; 8.5 mm x 7.1 mm; 11.1 mm diagonal	
Pixel size	3.45 $\mu\text{m}$ x 3.45 $\mu\text{m}$	
CRA	0 deg	
ADC	12-bit	
YUV color pixel formats	Not applicable	YUV422 8-bit (UYVY)
RGB color pixel formats	Default: RGB888 (RGB3)	
RAW pixel formats	RAW8 (GREY), RAW10 (Y10), RAW12 (Y12)	
Maximum image bit depth	12-bit	
Maximum frame rate	65 fps, using 4 lanes	
Exposure time	176 $\mu\text{s}$ to 10 s (4 lanes), 175 $\mu\text{s}$ to 10 s (2 lanes), 165 $\mu\text{s}$ to 10 s (1 lane)	
Image buffer (RAM)	256 KB	
Non-volatile memory (Flash)	1024 KB	
Gain	0 dB to 24 dB; 0.1 dB increments	
GPIOs	2 programmable GPIOs As direct inputs (push-pull): 0 to 5.5 VDC As direct outputs (push-pull): 0 to 3.3 VDC at 12 mA	
Power requirements	Power over MIPI CSI-2	
Power consumption (typical, at 5 VDC)	2.8 W	

Table 37: Alvium 1800 C-508m/c specifications (sheet 1 of 2)

Feature	Specification			
	1800 C-508m/C			
Operating temperature	Hardware option	Housing	Cooling areas <sup>1</sup>	Mainboard <sup>2</sup>
	Bare board <sup>3</sup>	Not applicable	+5 °C to +85 °C	+5 °C to +85 °C
	Open housing <sup>4</sup>	+5 °C to +65 °C		
Relative humidity	0% to 80% (non-condensing)			
Digital interface	MIPI CSI-2 D-PHY V1.1; 1, 2, or 4 lanes; maximum 1.125 Gbps per lane			
Camera controls	V4L2 controls (Video4Linux Access), Direct Register Access			
<sup>1</sup> See <a href="#">Mounting the heat sink</a> on page 162. <sup>2</sup> Output by <b>Device Temperature</b> <sup>3</sup> Ensure that the sensor is operated in the temperature range specified by the manufacturer. For any questions, please visit <a href="http://www.alliedvision.com/en/support">www.alliedvision.com/en/support</a> . <sup>4</sup> Temperature values must be observed for the housing <b>and</b> for the cooling areas.				

Table 37: Alvium 1800 C-508m/c specifications (sheet 2 of 2)

### Absolute QE

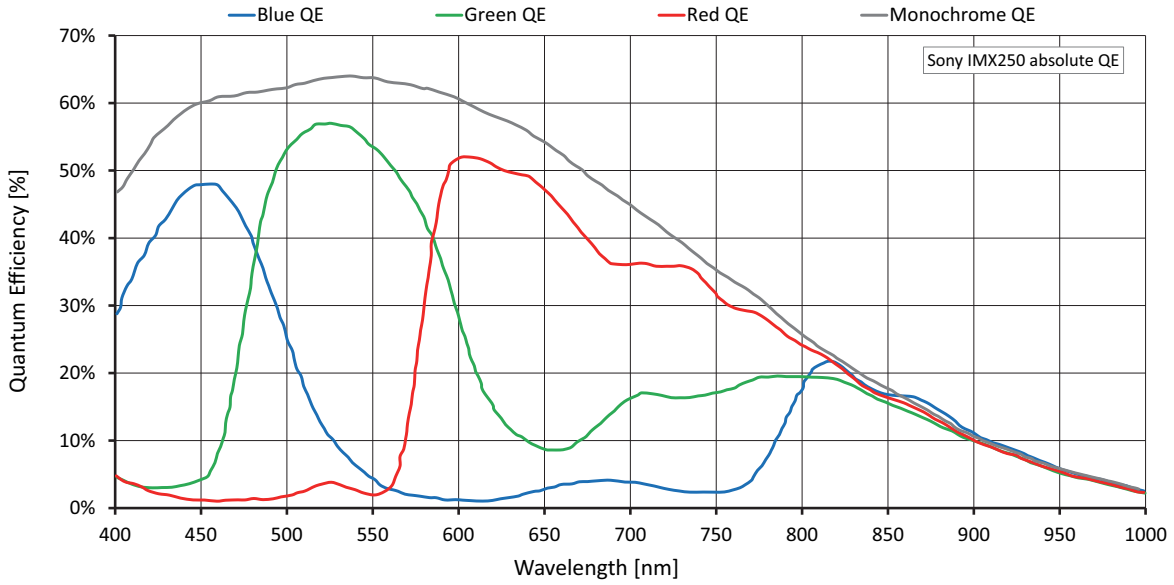

Figure 26: Alvium 1800 C-508m/c (Sony IMX250) absolute QE

### Spectral response

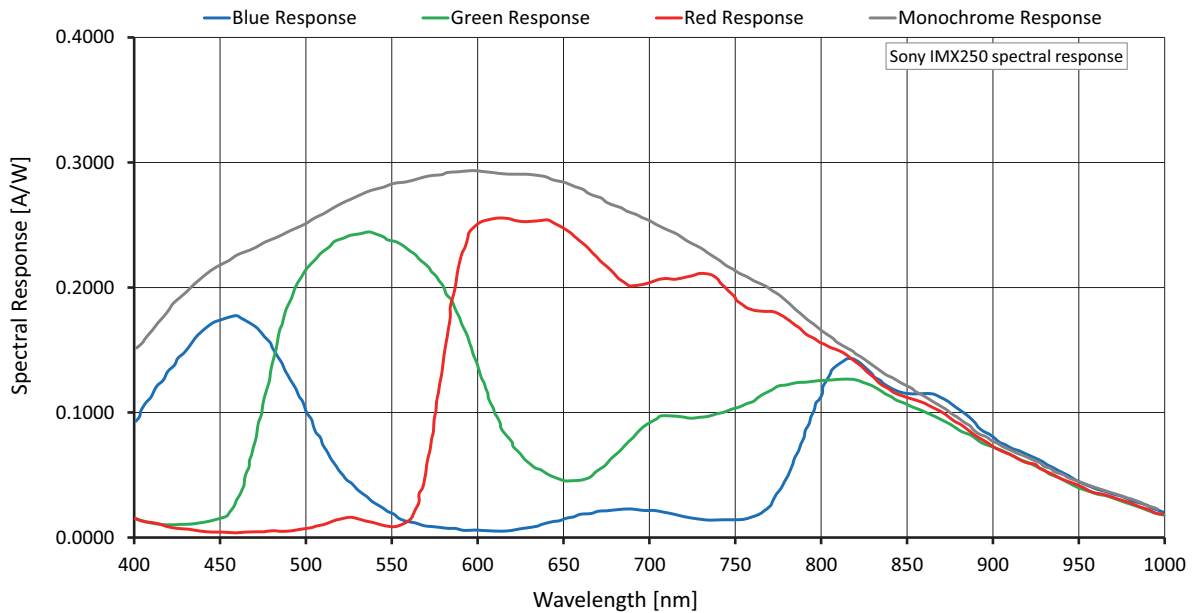

Figure 27: Alvium 1800 C-508m/c (Sony IMX250) spectral response

## Frame rates with Cropping

Values were calculated for **typical operation** defined in [Frame rates with Cropping/ROI frame rates](#) on page 49.

Frame rates at maximum bandwidth calculates for 1.051 Gbps per lane. To reach the maximum frame rate available for typical operation, the bandwidth for image traffic is at 4 lanes with 4.204 Gbps.

Image format	Width [pixels]	Height [pixels]	ROI area [pixels]	Frame rate [fps]		
				4-lane	2-lane	1-lane
				4.204 Gbps	2.102 Gbps	1.051 Gbps
Full resolution	2,464	2,056	5,065,984	65	49	24
QXGA	2,048	1,536	3,145,728	86	78	39
Full HD	1,920	1,080	2,073,600	120	115	59
UXGA	1,600	1,200	1,920,000	109		64
WXGA+ <sup>1</sup>	1,440	904 <sup>1</sup>	1,301,760	142		92
SXGA	1,280	1,024	1,310,720	127		92
HD 720	1,280	720	921,600	175		128
XGA	1,024	768	786,432	166		149
SVGA	800	600	480,000	208		
VGA	640	480	307,200	254		
QVGA	320	240	76,800	451		
QQVGA	160	120	19,200	733		
Maximum × half <sup>2</sup>	2,464	1,032 <sup>2</sup>	2,542,848	124	93	48
Maximum × minimum	2,464	16	39,424	1,111	952	617
Minimum × maximum	16	2,056	32,896	66		
Minimum × minimum	16	16	256	1,580		

<sup>1</sup> Instead of 1,440 × 900  
<sup>2</sup> Instead of 2,464 × 1,028  
 Due to increments, some resolutions are not available. In this case, frame rates were calculated for the next available resolution.

Table 38: Alvim 1800 C-508m/c ROI frame rates at maximum bandwidth

## Alvium 1800 C-511m/c

Feature	Specification	
	1800 C-511m (monochrome)	1800 C-511c (color)
Sensor model	Sony IMX547-AAMJ	Sony IMX547-AAQJ
Resolution	2464 (H) × 2064 (V); 5.1 MP	
Sensor type	CMOS	
Shutter type	Global shutter (GS)	
Sensor size	Type 1/1.8; 6.75 mm × 5.66 mm; 8.8 mm diagonal	
Pixel size	2.74 μm × 2.74 μm	
CRA	0 deg	
ADC	12-bit	
YUV color pixel formats	Not applicable	YUV422 8-bit (UYVY)
RGB color pixel formats	Default: RGB888 (RGB3)	
RAW pixel formats	RAW8 (GREY), RAW10 (Y10), RAW12 (Y12)	
Maximum image bit depth	12-bit	
Maximum frame rate	78 fps, using 4 lanes	
Exposure time	164 μs to 10 s (4 lanes), 163 μs to 10 s (2 lanes), 153 μs to 10 s (1 lane)	
Image buffer (RAM)	256 KB	
Non-volatile memory (Flash)	1024 KB	
Gain	0 dB to 24 dB; 0.1 dB increments	
GPIOs	2 programmable GPIOs As direct inputs (push-pull): 0 to 5.5 VDC As direct outputs (push-pull): 0 to 3.3 VDC at 12 mA	
Power requirements	Power over MIPI CSI-2	
Power consumption (typical, at 5 VDC)	3.0 W	

Table 39: Alvium 1800 C-511m/c specifications (sheet 1 of 2)

Feature	Specification			
	1800 C-511m/c			
Operating temperature	Hardware option	Housing	Cooling areas <sup>1</sup>	Mainboard <sup>2</sup>
	Bare board <sup>3</sup>	Not applicable	+5 °C to +85 °C	+5 °C to +85 °C
	Open housing <sup>4</sup>	+5 °C to +65 °C		
Relative humidity	0% to 80% (non-condensing)			
Digital interface	MIPI CSI-2 D-PHY V1.1; 1, 2, or 4 lanes; maximum 1.125 Gbps per lane			
Camera controls	V4L2 controls (Video4Linux Access), Direct Register Access			
<sup>1</sup> See <a href="#">Mounting the heat sink</a> on page 162. <sup>2</sup> Output by <b>Device Temperature</b> <sup>3</sup> Ensure that the sensor is operated in the temperature range specified by the manufacturer. For any questions, please visit <a href="http://www.alliedvision.com/en/support">www.alliedvision.com/en/support</a> . <sup>4</sup> Temperature values must be observed for the housing <b>and</b> for the cooling areas.				

Table 39: Alvium 1800 C-511m/c specifications (sheet 2 of 2)



### Absolute QE

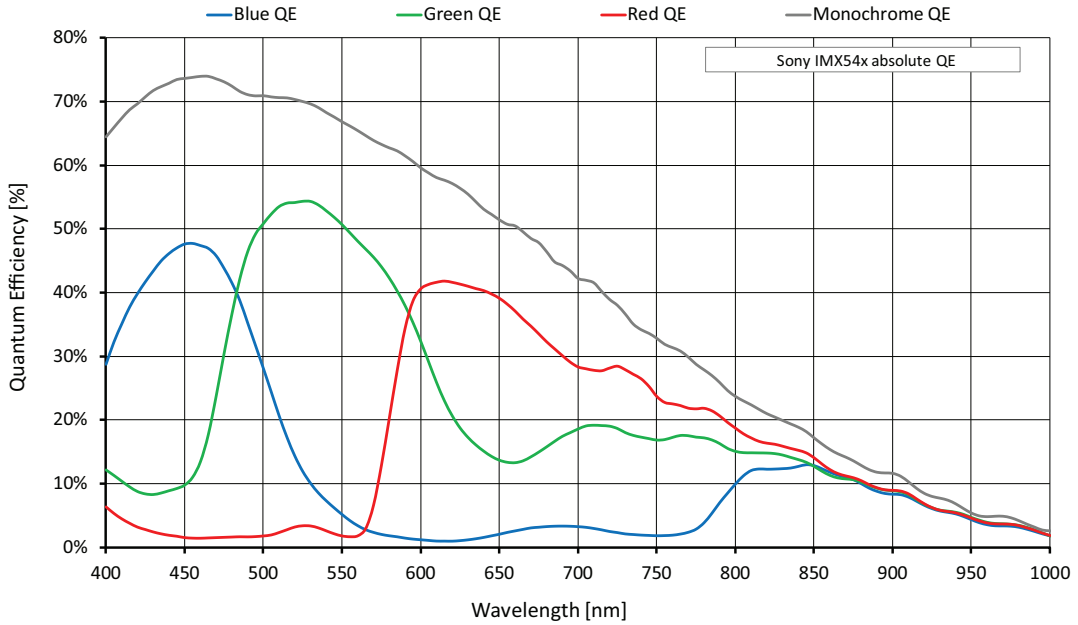

Figure 28: Alvium 1800 C-511m/c (Sony IMX547) absolute QE

### Spectral response

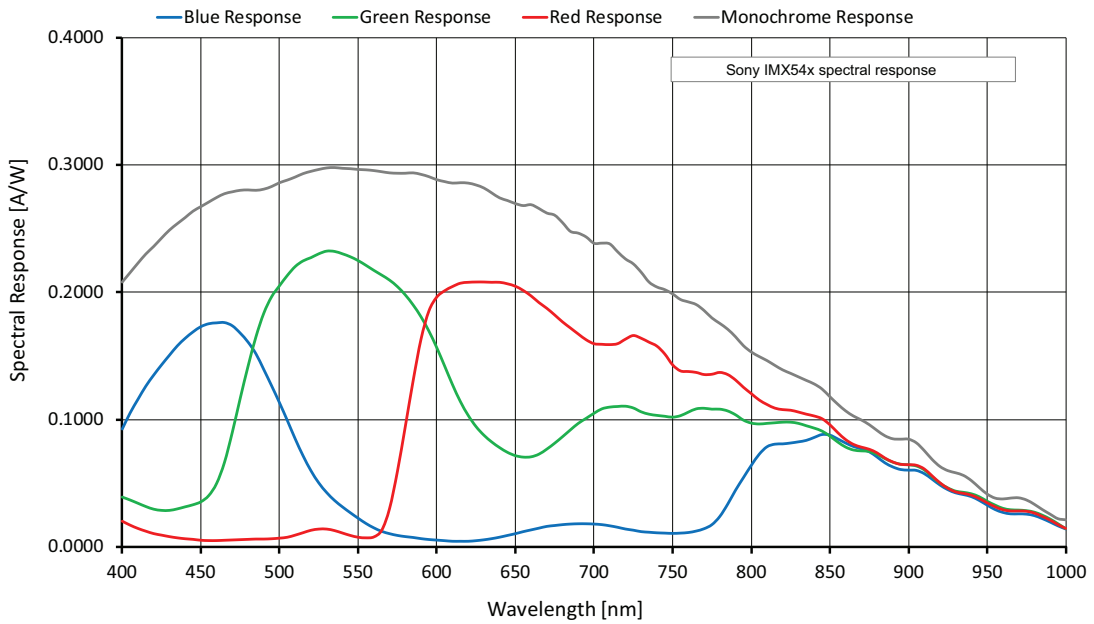

Figure 29: Alvium 1800 C-511m/c (Sony IMX547) spectral response

## Frame rates with Cropping

Values were calculated for **typical operation** defined in [Frame rates with Cropping/ROI frame rates](#) on page 49.

Frame rates at maximum bandwidth calculates for 1.051 Gbps per lane. To reach the maximum frame rate available for typical operation, the bandwidth for image traffic is at 4 lanes with 4.204 Gbps.

Image format	Width [pixels]	Height [pixels]	ROI area [pixels]	Frame rate [fps]		
				4-lane	2-lane	1-lane
				4.204 Gbps	2.102 Gbps	1.051 Gbps
Full resolution	2,464	2,064	5,085,696	78	47	23
QXGA	2,048	1,536	3,145,728	103	74	37
Full HD	1,920	1,080	2,073,600	139	107	54
UXGA	1,600	1,200	1,920,000	128	116	59
WXGA+ <sup>1</sup>	1,440	904 <sup>1</sup>	1,301,760	162		84
SXGA	1,280	1,024	1,310,720	147		85
HD 720	1,280	720	921,600	195		114
XGA	1,024	768	786,432	186		134
SVGA	800	600	480,000	227		207
VGA	640	480	307,200	268		
QVGA	320	240	76,800	419		
QQVGA	160	120	19,200	581		
Maximum × half	2,464	1,032	2,542,848	1,44	86	44
Maximum × minimum	2,464	16	39,424	770	514	285
Minimum × maximum	16	2,064	33,024	79		
Minimum × minimum	16	16	256	874		

<sup>1</sup> Instead of 1,440 × 900

Due to increments, some resolutions are not available. In this case, frame rates were calculated for the next available resolution.

Table 40: Alvium 1800 C-511m/c ROI frame rates at maximum bandwidth

## Alvium 1800 C-811m/c

Feature	Specification	
	1800 C-811m (monochrome)	1800 C-811c (color)
Sensor model	Sony IMX546-AAMJ	Sony IMX546-AAQJ
Resolution	2848 (H) × 2848 (V); 8.1 MP	
Sensor type	CMOS	
Shutter type	Global shutter (GS)	
Sensor size	Type 2/3; 7.8 mm × 7.8 mm; 11 mm diagonal	
Pixel size	2.74 μm × 2.74 μm	
CRA	0 deg	
ADC	12-bit	
YUV color pixel formats	Not applicable	YUV422 8-bit (UYVY)
RGB color pixel formats	Default: RGB888 (RGB3)	
RAW pixel formats	RAW8 (GREY), RAW10 (Y10), RAW12 (Y12)	
Maximum image bit depth	12-bit	
Maximum frame rate	58 fps, using 4 lanes	
Exposure time	164 μs to 10 s (4 lanes), 166 μs to 10 s (2 lanes), 155 μs to 10 s (1 lane)	
Image buffer (RAM)	256 KB	
Non-volatile memory (Flash)	1024 KB	
Gain	0 dB to 24 dB; 0.1 dB increments	
GPIOs	2 programmable GPIOs As direct inputs (push-pull): 0 to 5.5 VDC As direct outputs (push-pull): 0 to 3.3 VDC at 12 mA	
Power requirements	Power over MIPI CSI-2	
Power consumption (typical, at 5 VDC)	3.1 W	

Table 41: Alvium 1800 C-811m/c specifications (sheet 1 of 2)

Feature	Specification			
	1800 C-811m/c			
Operating temperature	Hardware option	Housing	Cooling areas <sup>1</sup>	Mainboard <sup>2</sup>
		Bare board <sup>3</sup>	Not applicable	+5 °C to +85 °C
	Open housing <sup>4</sup>	+5 °C to +65 °C		
Relative humidity	0% to 80% (non-condensing)			
Digital interface	MIPI CSI-2 D-PHY V1.1; 1, 2, or 4 lanes; maximum 1.125 Gbps per lane			
Camera controls	V4L2 controls (Video4Linux Access), Direct Register Access			
<sup>1</sup> See <a href="#">Mounting the heat sink</a> on page 162. <sup>2</sup> Output by <b>Device Temperature</b> <sup>3</sup> Ensure that the sensor is operated in the temperature range specified by the manufacturer. For any questions, please visit <a href="http://www.alliedvision.com/en/support">www.alliedvision.com/en/support</a> . <sup>4</sup> Temperature values must be observed for the housing <b>and</b> for the cooling areas.				

Table 41: Alvium 1800 C-811m/c specifications (sheet 2 of 2)

## Absolute QE

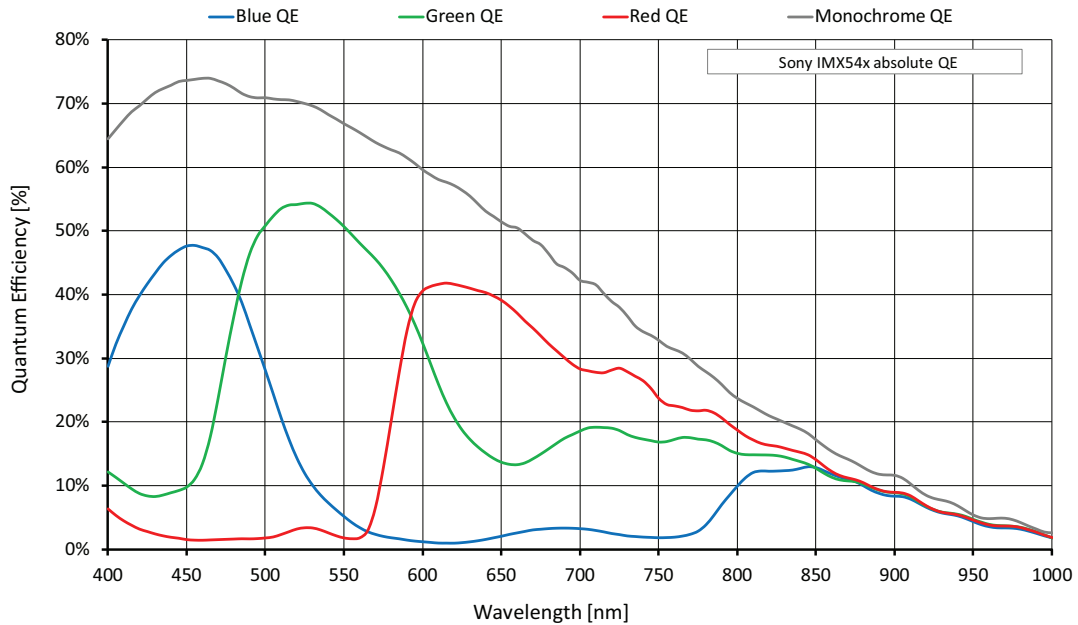

Figure 30: Alvium 1800 C-811m/c (Sony IMX546) absolute QE

## Spectral response

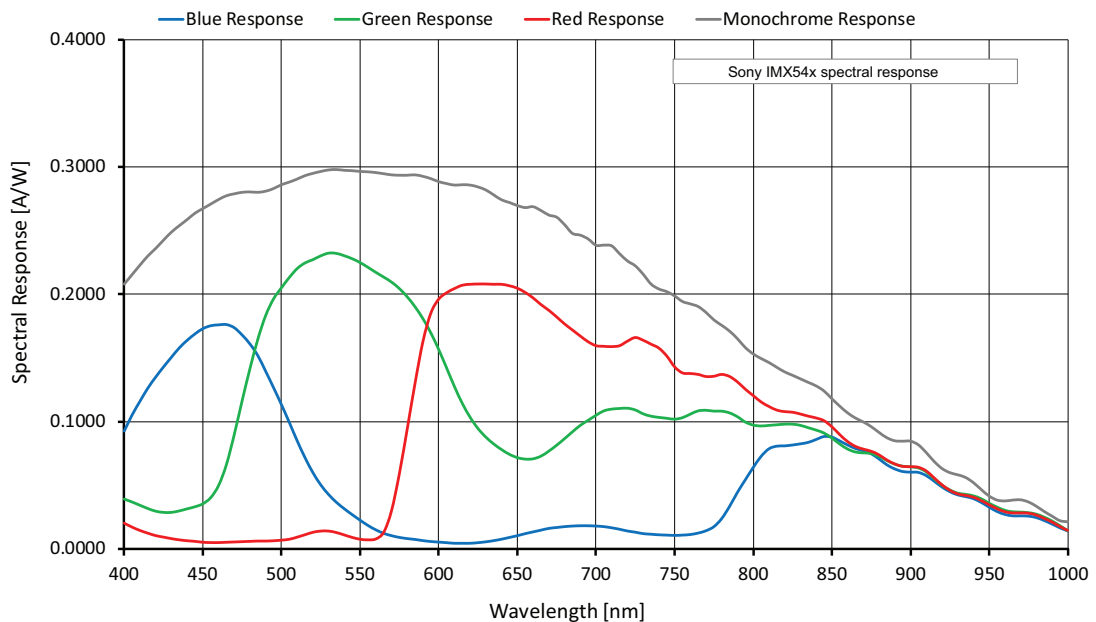

Figure 31: Alvium 1800 C-811m/c (Sony IMX546) spectral response

## Frame rates with Cropping

Values were calculated for **typical operation** defined in [Frame rates with Cropping/ROI frame rates](#) on page 49.

Frame rates at maximum bandwidth calculates for 1.051 Gbps per lane. To reach the maximum frame rate available for typical operation, the bandwidth for image traffic is at 4 lanes with 4.204 Gbps.

Image format	Width [pixels]	Height [pixels]	ROI area [pixels]	Frame rate [fps]		
				4-lane	2-lane	1-lane
				4.204 Gbps	2.102 Gbps	1.051 Gbps
Full resolution	2,848	2,848	8,111,104	58	30	15
QSXGA	2,560	2,048	5,242,880	79	45	23
WQHD	2,560	1,440	3,686,400	108	62	31
QXGA	2,048	1,536	3,145,728	103	74	37
Full HD	1,920	1,080	2,073,600	139	107	54
UXGA	1,600	1,200	1,920,000	128	116	59
WXGA <sup>1</sup>	1,440	904 <sup>1</sup>	1,301,760	162		84
SXGA	1,280	1,024	1,310,720	147		85
HD 720	1,280	720	921,600	195		114
XGA	1,024	768	786,432	186		134
SVGA	800	600	480,000	227		207
VGA	640	480	307,200	268		
QVGA	320	240	76,800	419		
QQVGA	160	120	19,200	581		
Maximum × half	2,848	1,424	4,055,552	109	57	28
Maximum × minimum	2,848	16	45,568	754	450	248
Minimum × maximum	16	2,848	45,568	59		
Minimum × minimum	16	16	256	874		

<sup>1</sup> Instead of 1,440 × 900  
 Due to increments, some resolutions are not available. In this case, frame rates were calculated for the next available resolution.

Table 42: Alvim 1800 C-811m/c ROI frame rates at maximum bandwidth

## Alvium 1800 C-1236m/c

Feature	Specification	
	1800 C-1236m (monochrome)	1800 C-1236c (color)
Sensor model	Sony IMX304	
Resolution	4112 (H) × 3008 (V); 12.4 MP	
Sensor type	CMOS	
Shutter type	Global shutter (GS)	
Sensor size	Type 1.1; 14.2 mm × 10.4 mm; 17.6 mm diagonal	
Pixel size	3.45 μm × 3.45 μm	
CRA	0 deg	
ADC	12-bit	
YUV color pixel formats	Not applicable	YUV422 8-bit (UYVY)
RGB color pixel formats	Default: RGB888 (RGB3)	
RAW pixel formats	RAW8 (GREY), RAW10 (Y10), RAW12 (Y12)	
Maximum image bit depth	12-bit	
Maximum frame rate	22 fps, using 4 lanes	
Exposure time	169 μs to 10 s (4 lanes), 172 μs to 10 s (1 to 2 lanes)	
Image buffer (RAM)	256 KB	
Non-volatile memory (Flash)	1024 KB	
Gain	0 dB to 24 dB; 0.1 dB increments	
GPIOs	2 programmable GPIOs As direct inputs (push-pull): 0 to 5.5 VDC As direct outputs (push-pull): 0 to 3.3 VDC at 12 mA	
Power requirements	Power over MIPI CSI-2	
Power consumption (typical, at 5 VDC)	2.6 W	

Table 43: Alvium 1800 C-1236m/c specifications (sheet 1 of 2)

Feature	Specification			
	1800 C-1236m/c			
Operating temperature	Hardware option	Housing	Cooling areas <sup>1</sup>	Mainboard <sup>2</sup>
	Bare board <sup>3</sup>	Not applicable	+5 °C to +85 °C	+5 °C to +88 °C
	Open housing <sup>4</sup>	+5 °C to +65 °C		
Relative humidity	0% to 80% (non-condensing)			
Digital interface	MIPI CSI-2 D-PHY V1.1; 1, 2, or 4 lanes; maximum 1.125 Gbps per lane			
Camera controls	V4L2 controls (Video4Linux Access), Direct Register Access			
<sup>1</sup> See <a href="#">Mounting the heat sink</a> on page 162. <sup>2</sup> Output by <b>Device Temperature</b> <sup>3</sup> Ensure that the sensor is operated in the temperature range specified by the manufacturer. For any questions, please visit <a href="http://www.alliedvision.com/en/support">www.alliedvision.com/en/support</a> . <sup>4</sup> Temperature values must be observed for the housing <b>and</b> for the cooling areas.				

Table 43: Alvium 1800 C-1236m/c specifications (sheet 2 of 2)



### Absolute QE

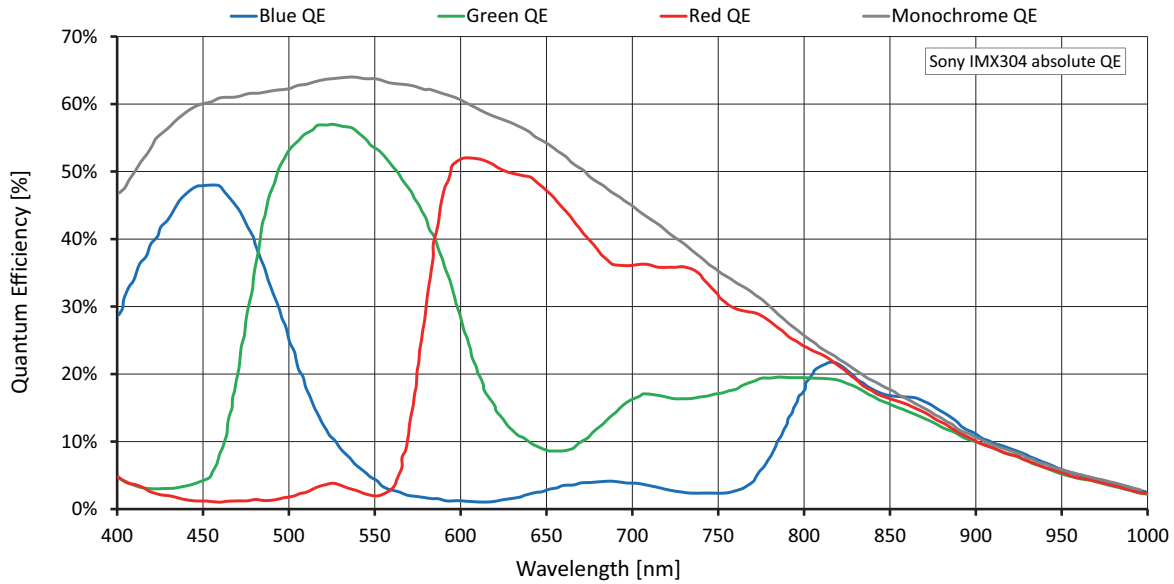

Figure 32: Alvium 1800 C-1236m/c (Sony IMX304) absolute QE

### Spectral response

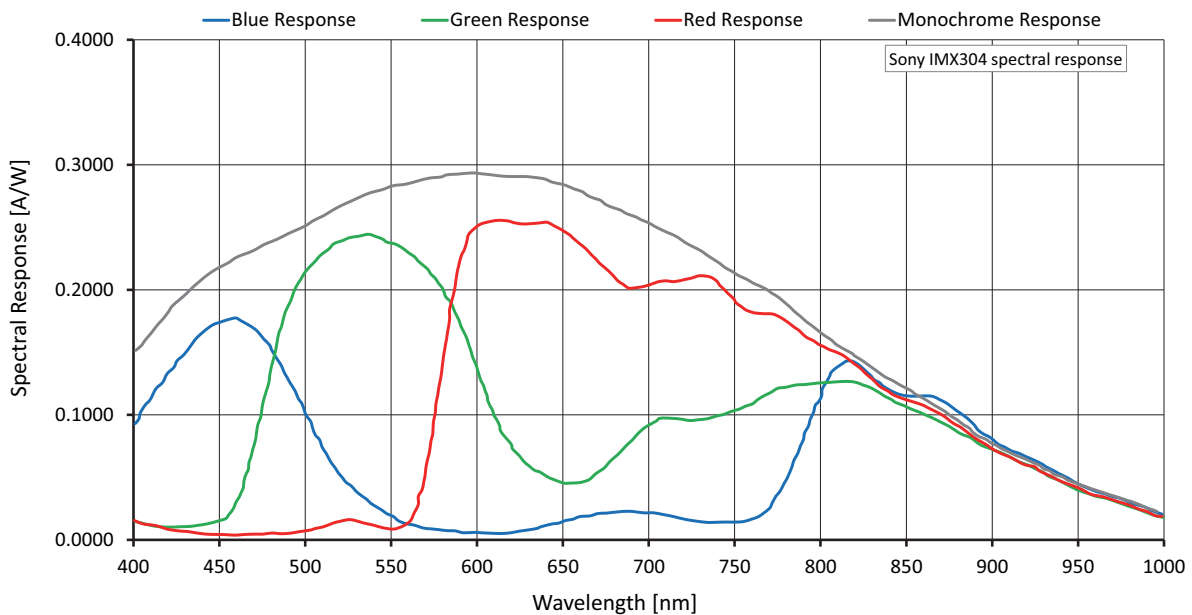

Figure 33: Alvium 1800 C-1236m/c (Sony IMX304) spectral response

## Frame rates with Cropping

Values were calculated for **typical operation** defined in [Frame rates with Cropping/ROI frame rates](#) on page 49.

Frame rates at maximum bandwidth calculates for 1.051 Gbps per lane. To reach the maximum frame rate available for typical operation, the bandwidth for image traffic is at 4 lanes with 4.204 Gbps.

Image format	Width [pixels]	Height [pixels]	ROI area [pixels]	Frame rate [fps]		
				4-lane	2-lane	1-lane
				4.204 Gbps	2.102 Gbps	1.051 Gbps
Full resolution	4,112	3,008	12,368,896	22	20	10
UHD 4K	3,840	2,160	8,294,400	31	30	15
QSXGA	2,560	2,048	5,242,880	33		24
WQHD	2,560	1,440	3,686,400	46		33
QXGA	2,048	1,536	3,145,728	44		39
Full HD	1,920	1,080	2,073,600	61		59
UXGA	1,600	1,200	1,920,000		55	
WXGA <sup>1</sup>	1,440	904 <sup>1</sup>	1,301,760		72	
SXGA	1,280	1,024	1,310,720		65	
HD 720	1,280	720	921,600		90	
XGA	1,024	768	786,432		85	
SVGA	800	600	480,000		106	
VGA	640	480	307,200		130	
QVGA	320	240	76,800		235	
QQVGA	160	120	19,200		392	
Maximum × half	4,112	1,504	6,184,448	44	40	20
Maximum × minimum	4,112	16	65,792	640	601	375
Minimum × maximum	16	3,008	48,128		23	
Minimum × minimum	16	16	256		923	

<sup>1</sup> Instead of 1,440 × 900  
 Due to increments, some resolutions are not available. In this case, frame rates were calculated for the next available resolution.

Table 44: Alvium 1800 C-1236m/c ROI frame rates at maximum bandwidth

## Alvium 1800 C-1240m/c

Feature	Specification	
	1800 C-1240m (monochrome)	1800 C-1240c (color)
Sensor model	Sony IMX226	
Resolution	4024 (H) x 3036 (V); 12.2 MP	
Sensor type	CMOS	
Shutter type	Rolling shutter (RS)	
Sensor size	Type 1/1.7; 7.4 mm x 5.6 mm; 9.33 mm diagonal	
Pixel size	1.85 $\mu\text{m}$ x 1.85 $\mu\text{m}$	
CRA	0 deg	
ADC	10-bit	
YUV color pixel formats	Not applicable	YUV422 8-bit (UYVY)
RGB color pixel formats	Default: RGB888 (RGB3)	
RAW pixel formats	RAW8 (GREY), RAW10 (Y10)	
Maximum image bit depth	10-bit	
Maximum frame rate	41 fps, using 4 lanes	
Exposure time	10 $\mu\text{s}$ to 10 s (4 lanes), 18 $\mu\text{s}$ to 10 s (2 lanes), 33 $\mu\text{s}$ to 10 s (1 lane)	
Image buffer (RAM)	256 KB	
Non-volatile memory (Flash)	1024 KB	
Gain	0 dB to 27 dB; 0.1 dB increments	
GPIOs	2 programmable GPIOs As direct inputs (push-pull): 0 to 5.5 VDC As direct outputs (push-pull): 0 to 3.3 VDC at 12 mA	
Power requirements	Power over MIPI CSI-2	
Power consumption (typical, at 5 VDC)	2.9 W	

Table 45: Alvium 1800 C-1240m/c specifications (sheet 1 of 2)

Feature	Specification			
	1800 C-1240m/c			
Operating temperature	Hardware option	Housing	Cooling areas <sup>2</sup>	Mainboard <sup>3</sup>
	Bare board <sup>4</sup>	Not applicable	+5 °C to +85 °C	+5 °C to +88 °C
	Open housing <sup>5</sup>	+5 °C to +65 °C		
Relative humidity	0% to 80% (non-condensing)			
Digital interface	MIPI CSI-2 D-PHY V1.1; 1, 2, or 4 lanes; maximum 1.125 Gbps per lane			
Camera controls	V4L2 controls (Video4Linux Access), Direct Register Access			
<sup>2</sup> See <a href="#">Mounting the heat sink</a> on page 162. <sup>3</sup> Output by <b>Device Temperature</b> <sup>4</sup> Ensure that the sensor is operated in the temperature range specified by the manufacturer. For any questions, please visit <a href="http://www.alliedvision.com/en/support">www.alliedvision.com/en/support</a> . <sup>5</sup> Temperature values must be observed for the housing <b>and</b> for the cooling areas.				

Table 45: Alvium 1800 C-1240m/c specifications (sheet 2 of 2)

### Absolute QE

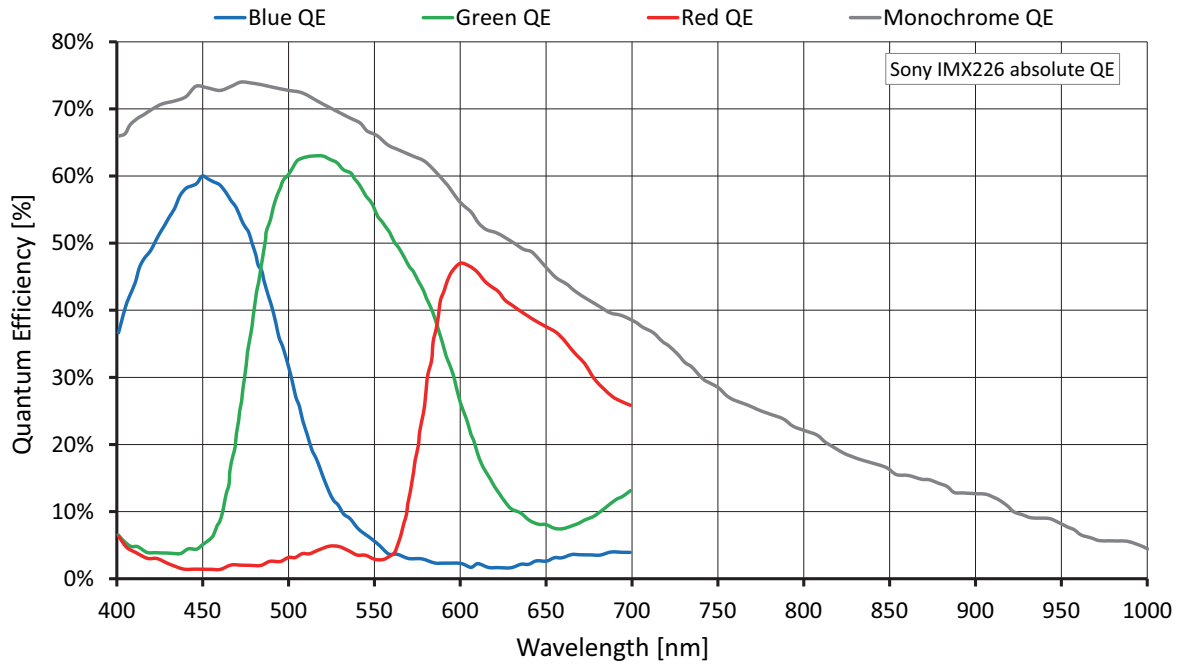

Figure 34: Alvium 1800 C-1240m/c (Sony IMX226) absolute QE

### Spectral response

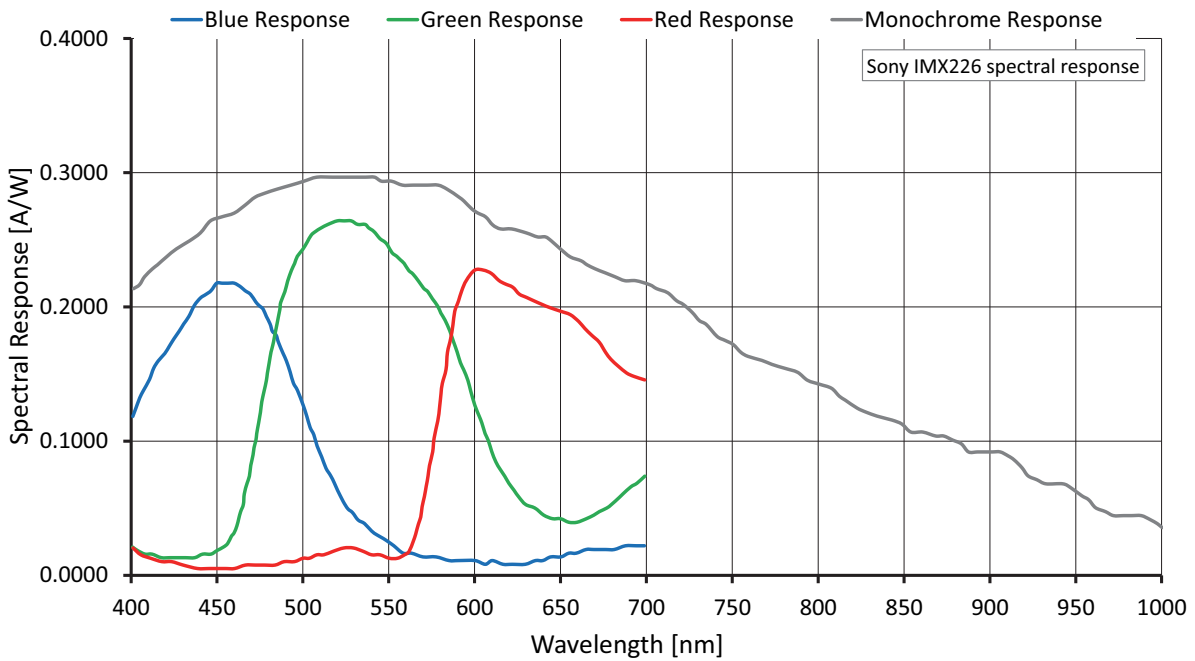

Figure 35: Alvium 1800 C-1240m/c (Sony IMX226) spectral response

## Frame rates with Cropping

Values were calculated for **typical operation** defined in [Frame rates with Cropping/ROI frame rates](#) on page 49.

Frame rates at maximum bandwidth calculates for 1.051 Gbps per lane. To reach the maximum frame rate available for typical operation, the bandwidth for image traffic is at 4 lanes with 4.204 Gbps.

Image format	Width [pixels]	Height [pixels]	ROI area [pixels]	Frame rate [fps]		
				4-lane	2-lane	1-lane
				4.204 Gbps	2.102 Gbps	1.051 Gbps
Full resolution	4,024	3,036	12,216,864	41	20	10
UHD 4K	3,840	2,160	8,294,400			
QSXGA	2,560	2,048	5,242,880			
WQHD	2,560	1,440	3,686,400			
QXGA	2,048	1,536	3,145,728			
Full HD	1,920	1,080	2,073,600			
UXGA	1,600	1,200	1,920,000			
WXGA+ <sup>1</sup>	1,440	904 <sup>1</sup>	1,301,760			
SXGA	1,280	1,024	1,310,720			
HD 720	1,280	720	921,600			
XGA	1,024	768	786,432			
SVGA	800	600	480,000			
VGA	640	480	307,200			
QVGA	320	240	76,800			
QQVGA	160	120	19,200			
Maximum × half <sup>2</sup>	4,024	1,520 <sup>2</sup>	6,116,480			
Maximum × minimum	4,024	16	64,384			
Minimum × maximum	16	3,036	48,576			
Minimum × minimum	16	16	256			

<sup>1</sup> Instead of 1,440 × 900  
<sup>2</sup> Instead of 4,024 × 1,518  
 Due to increments, some resolutions are not available. In this case, frame rates were calculated for the next available resolution.

Table 46: Alvium 1800 C-1240m/c ROI frame rates at maximum bandwidth



### Values in triggered mode

When rolling shutter cameras are operated in triggered mode, the values for maximum frame rate reached in free run mode are cut in half.

## Alvium 1800 C-1242m/c

Feature	Specification	
	1800 C-1242m (monochrome)	1800 C-1242c (color)
Sensor model	Sony IMX545-AAMJ	Sony IMX545-AAQJ
Resolution	4128 (H) × 3008 (V); 12.4 MP	
Sensor type	CMOS	
Shutter type	Global shutter (GS)	
Sensor size	Type 1/1.1; 11.31 mm × 8.24 mm; 14 mm diagonal	
Pixel size	2.74 μm × 2.74 μm	
CRA	0 deg	
ADC	12-bit	
YUV color pixel formats	Not applicable	YUV422 8-bit (UYVY)
RGB color pixel formats	Default: RGB888 (RGB3)	
RAW pixel formats	RAW8 (GREY), RAW10 (Y10), RAW12 (Y12)	
Maximum image bit depth	12-bit	
Maximum frame rate	39 fps, using 4 lanes	
Exposure time	168 μs to 10 s (4 lanes), 160 μs to 10 s (1 to 2 lanes)	
Image buffer (RAM)	256 KB	
Non-volatile memory (Flash)	1024 KB	
Gain	0 dB to 24 dB; 0.1 dB increments	
GPIOs	2 programmable GPIOs As direct inputs (push-pull): 0 to 5.5 VDC As direct outputs (push-pull): 0 to 3.3 VDC at 12 mA	
Power requirements	Power over MIPI CSI-2	
Power consumption (typical, at 5 VDC)	3.2 W	

Table 47: Alvium 1800 C-1242m/c specifications (sheet 1 of 2)

Feature	Specification			
	1800 C-1242m/c			
Operating temperature	Hardware option	Housing	Cooling areas <sup>1</sup>	Mainboard <sup>2</sup>
		Bare board <sup>3</sup>	Not applicable	+5 °C to +85 °C
	Open housing <sup>4</sup>	+5 °C to +65 °C		
Relative humidity	0% to 80% (non-condensing)			
Digital interface	MIPI CSI-2 D-PHY V1.1; 1, 2, or 4 lanes; maximum 1.125 Gbps per lane			
Camera controls	V4L2 controls (Video4Linux Access), Direct Register Access			
<sup>1</sup> See <a href="#">Mounting the heat sink</a> on page 162. <sup>2</sup> Output by <b>Device Temperature</b> <sup>3</sup> Ensure that the sensor is operated in the temperature range specified by the manufacturer. For any questions, please visit <a href="http://www.alliedvision.com/en/support">www.alliedvision.com/en/support</a> . <sup>4</sup> Temperature values must be observed for the housing <b>and</b> for the cooling areas.				

Table 47: Alvium 1800 C-1242m/c specifications (sheet 2 of 2)



## Absolute QE

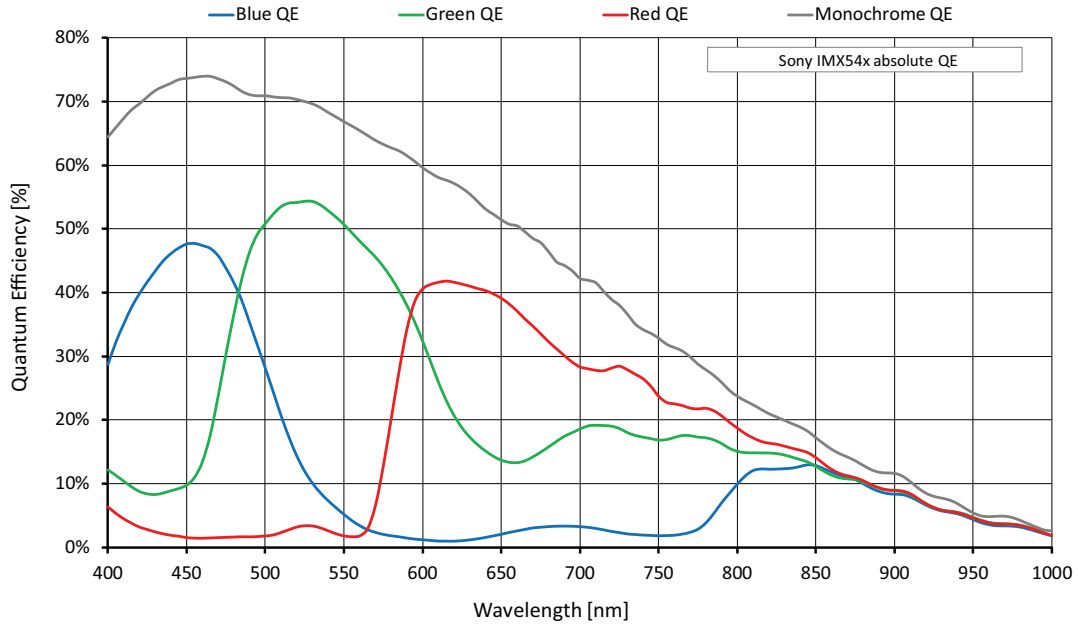

Figure 36: Alvium 1800 C-1242m/c (Sony IMX545) absolute QE

## Spectral response

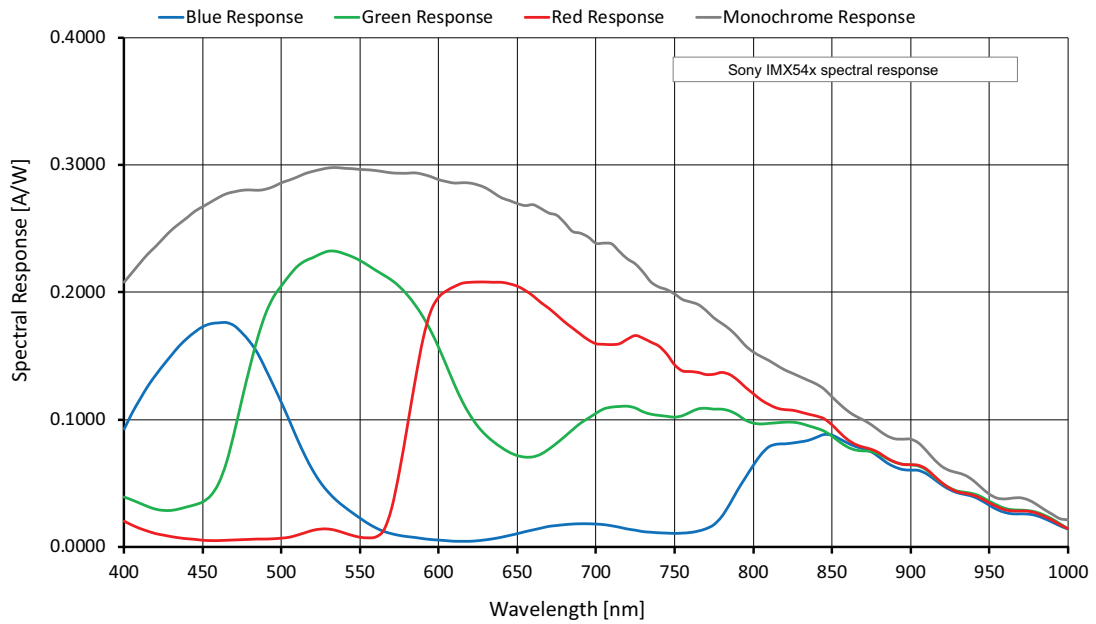

Figure 37: Alvium 1800 C-1242m/c (Sony IMX545) spectral response

## Frame rates with Cropping

Values were calculated for **typical operation** defined in [Frame rates with Cropping/ROI frame rates](#) on page 49.

Frame rates at maximum bandwidth calculates for 1.051 Gbps per lane. To reach the maximum frame rate available for typical operation, the bandwidth for image traffic is at 4 lanes with 4.204 Gbps.

Image format	Width [pixels]	Height [pixels]	ROI area [pixels]	Frame rate [fps]		
				4-lane	2-lane	1-lane
				4.204 Gbps	2.102 Gbps	1.051 Gbps
Full resolution	4,128	3,008	12,417,024	39	20	10
UHD 4K	3,840	2,160	8,294,400	55	29	14
QSXGA	2,560	2,048	5,242,880	58	46	23
WQHD	2,560	1,440	3,686,400	80	63	32
QXGA	2,048	1,536	3,145,728	76	74	37
Full HD	1,920	1,080	2,073,600	103		55
UXGA	1,600	1,200	1,920,000	95		60
WXGA <sup>1</sup>	1,440	904 <sup>1</sup>	1,301,760	121		85
SXGA	1,280	1,024	1,310,720	109		86
HD 720	1,280	720	921,600	146		116
XGA	1,024	768	786,432	139		136
SVGA	800	600	480,000	170		
VGA	640	480	307,200	202		
QVGA	320	240	76,800	324		
QQVGA	160	120	19,200	461		
Maximum × half	4,128	1,504	6,208,512	74	38	19
Maximum × minimum	4,128	16	66,048	588	347	190
Minimum × maximum	16	3,008	48,128	41		
Minimum × minimum	16	16	256	730		

<sup>1</sup> Instead of 1,440 × 900  
 Due to increments, some resolutions are not available. In this case, frame rates were calculated for the next available resolution.

Table 48: Alvium 1800 C-1242m/c ROI frame rates at maximum bandwidth

## Alvium 1800 C-1620m/c

Feature	Specification	
	1800 C-1620m (monochrome)	1800 C-1620c (color)
Sensor model	Sony IMX542-AAMJ	Sony IMX542-AAQJ
Resolution	5328 (H) × 3040 (V); 16.2 MP	
Sensor type	CMOS	
Shutter type	Global shutter (GS)	
Sensor size	Type 1.1; 14.6 mm × 8.33 mm; 16.8 mm diagonal	
Pixel size	2.74 μm × 2.74 μm	
CRA	0 deg	
ADC	12-bit	
YUV color pixel formats	Not applicable	YUV422 8-bit (UYVY)
RGB color pixel formats	Default: RGB888 (RGB3)	
RAW pixel formats	RAW8 (GREY), RAW10 (Y10), RAW12 (Y12)	
Maximum image bit depth	12-bit	
Maximum frame rate	30 fps, using 4 lanes	
Exposure time	165 μs to 10 s (1 to 4 lanes)	
Image buffer (RAM)	256 KB	
Non-volatile memory (Flash)	1024 KB	
Gain	0 dB to 24 dB; 0.1 dB increments	
GPIOs	2 programmable GPIOs As direct inputs (push-pull): 0 to 5.5 VDC As direct outputs (push-pull): 0 to 3.3 VDC at 12 mA	
Power requirements	Power over MIPI CSI-2	
Power consumption (typical, at 5 VDC)	3.8 W	

Table 49: Alvium 1800 C-1620m/c specifications (sheet 1 of 2)

Feature	Specification			
	1800 C-1620m/c			
Operating temperature	Hardware option	Housing	Cooling areas <sup>1</sup>	Mainboard <sup>2</sup>
	Bare board <sup>3</sup>	Not applicable	+5 °C to +85 °C	+5 °C to +85 °C
	Open housing <sup>4</sup>	+5 °C to +65 °C		
Relative humidity	0% to 80% (non-condensing)			
Digital interface	MIPI CSI-2 D-PHY V1.1; 1, 2, or 4 lanes; maximum 1.125 Gbps per lane			
Camera controls	V4L2 controls (Video4Linux Access), Direct Register Access			
<sup>1</sup> See <a href="#">Mounting the heat sink</a> on page 162. <sup>2</sup> Output by <b>Device Temperature</b> <sup>3</sup> Ensure that the sensor is operated in the temperature range specified by the manufacturer. For any questions, please visit <a href="http://www.alliedvision.com/en/support">www.alliedvision.com/en/support</a> . <sup>4</sup> Temperature values must be observed for the housing <b>and</b> for the cooling areas.				

Table 49: Alvium 1800 C-1620m/c specifications (sheet 2 of 2)

## Absolute QE

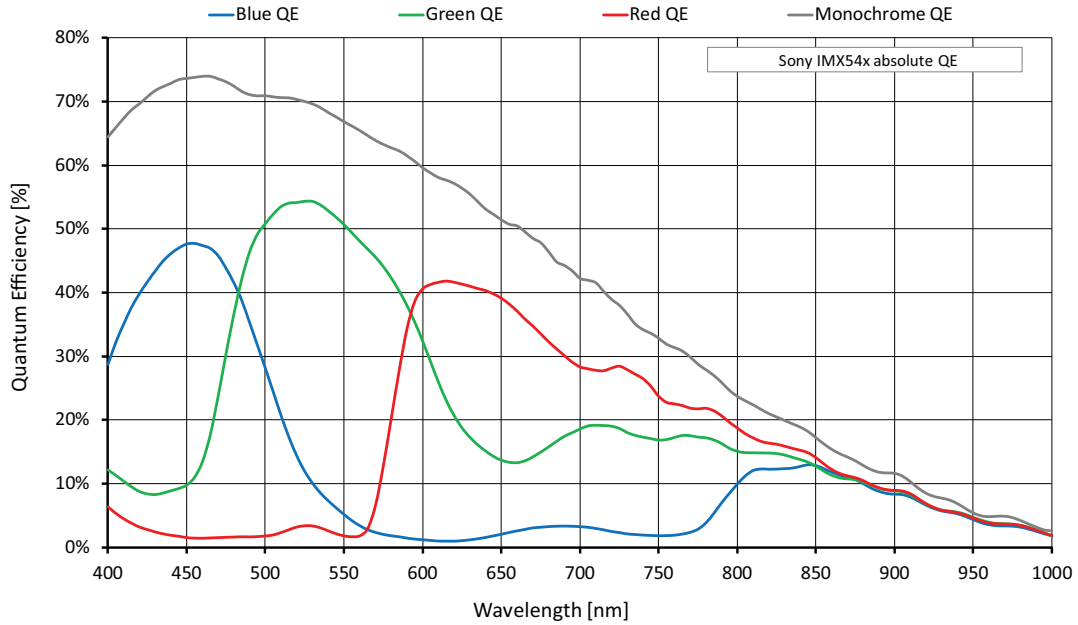

Figure 38: Alvium 1800 C-1620m/c (Sony IMX542) absolute QE

## Spectral response

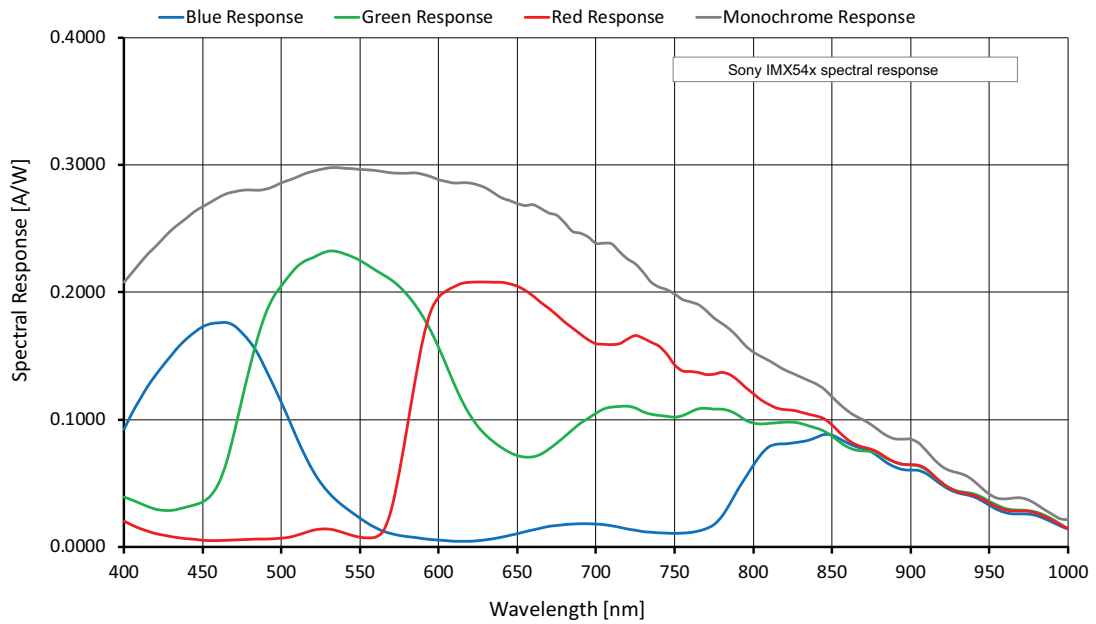

Figure 39: Alvium 1800 C-1620m/c (Sony IMX542) spectral response

## Frame rates with Cropping

Values were calculated for **typical operation** defined in [Frame rates with Cropping/ROI frame rates](#) on page 49.

Frame rates at maximum bandwidth calculates for 1.051 Gbps per lane. To reach the maximum frame rate available for typical operation, the bandwidth for image traffic is at 4 lanes with 4.204 Gbps.

Image format	Width [pixels]	Height [pixels]	ROI area [pixels]	Frame rate [fps]		
				4-lane	2-lane	1-lane
				4.204 Gbps	2.102 Gbps	1.051 Gbps
Full resolution	5,312	3,040	16,148,480	30	15	7
UHD 4K	3,840	2,160	8,294,400	44	29	14
QSXGA	2,560	2,048	5,242,880	46		23
WQHD	2,560	1,440	3,686,400	64		32
QXGA	2,048	1,536	3,145,728	61		38
Full HD	1,920	1,080	2,073,600	83		56
UXGA	1,600	1,200	1,920,000	76		61
WXGA <sup>1</sup>	1,440	904 <sup>1</sup>	1,301,760	98		86
SXGA	1,280	1,024	1,310,720	88		87
HD 720	1,280	720	921,600	119		118
XGA	1,024	768	786,432		113	
SVGA	800	600	480,000		139	
VGA	640	480	307,200		166	
QVGA	320	240	76,800		272	
QQVGA	160	120	19,200		399	
Maximum × half	5,312	1,520	8,074,240	58	29	14
Maximum × minimum	5,312	16	84,992	516	306	169
Minimum × maximum	16	3,040	48,640		32	
Minimum × minimum	16	16	256		669	

<sup>1</sup> Instead of 1,440 × 900  
 Due to increments, some resolutions are not available. In this case, frame rates were calculated for the next available resolution.

Table 50: Alvium 1800 C-1620m/c ROI frame rates at maximum bandwidth

## Alvium 1800 C-2040m/c

Feature	Specification	
	1800 C-2040m (monochrome)	1800 C-2040c (color)
Sensor model	Sony IMX541-AAMJ	Sony IMX541-AAQJ
Resolution	4512 (H) × 4512 (V); 20.4 MP	
Sensor type	CMOS	
Shutter type	Global shutter (GS)	
Sensor size	Type 1.1; 12.36 mm × 12.36 mm; 17.5 mm diagonal	
Pixel size	2.74 μm × 2.74 μm	
CRA	0 deg	
ADC	12-bit	
YUV color pixel formats	Not applicable	YUV422 8-bit (UYVY)
RGB color pixel formats	Default: RGB888 (RGB3)	
RAW pixel formats	RAW8 (GREY), RAW10 (Y10), RAW12 (Y12)	
Maximum image bit depth	12-bit	
Maximum frame rate	24 fps, using 4 lanes	
Exposure time	167 μs to 10 s (4 lanes), 158 μs to 10 s (2 lanes), 140 μs to 10 s (1 lane)	
Image buffer (RAM)	256 KB	
Non-volatile memory (Flash)	1024 KB	
Gain	0 dB to 24 dB; 0.1 dB increments	
GPIOs	2 programmable GPIOs As direct inputs (push-pull): 0 to 5.5 VDC As direct outputs (push-pull): 0 to 3.3 VDC at 12 mA	
Power requirements	Power over MIPI CSI-2	
Power consumption (typical, at 5 VDC)	3.7 W	

Table 51: Alvium 1800 C-2040m/c specifications (sheet 1 of 2)

Feature	Specification			
	1800 C-2040m/c			
Operating temperature	Hardware option	Housing	Cooling areas <sup>1</sup>	Mainboard <sup>2</sup>
	Bare board <sup>3</sup>	Not applicable	+5 °C to +85 °C	+5 °C to +85 °C
	Open housing <sup>4</sup>	+5 °C to +65 °C		
Relative humidity	0% to 80% (non-condensing)			
Digital interface	MIPI CSI-2 D-PHY V1.1; 1, 2, or 4 lanes; maximum 1.125 Gbps per lane			
Camera controls	V4L2 controls (Video4Linux Access), Direct Register Access			
<sup>1</sup> See <a href="#">Mounting the heat sink</a> on page 162. <sup>2</sup> Output by <b>Device Temperature</b> <sup>3</sup> Ensure that the sensor is operated in the temperature range specified by the manufacturer. For any questions, please visit <a href="http://www.alliedvision.com/en/support">www.alliedvision.com/en/support</a> . <sup>4</sup> Temperature values must be observed for the housing <b>and</b> for the cooling areas.				

Table 51: Alvium 1800 C-2040m/c specifications (sheet 2 of 2)



## Absolute QE

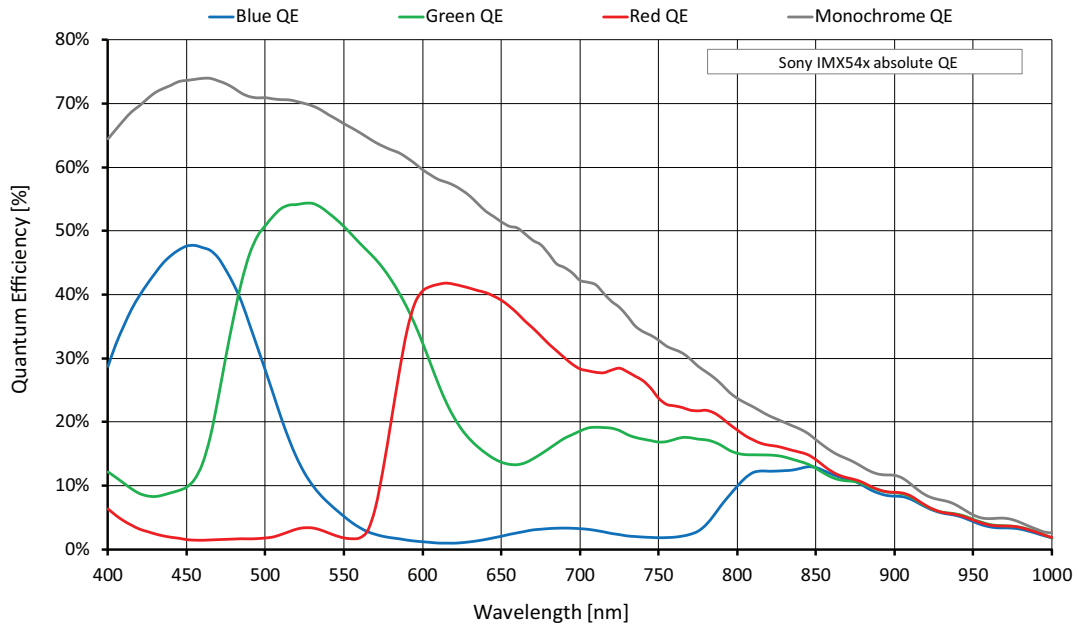

Figure 40: Alvium 1800 C-2040m/c (Sony IMX541) absolute QE

## Spectral response

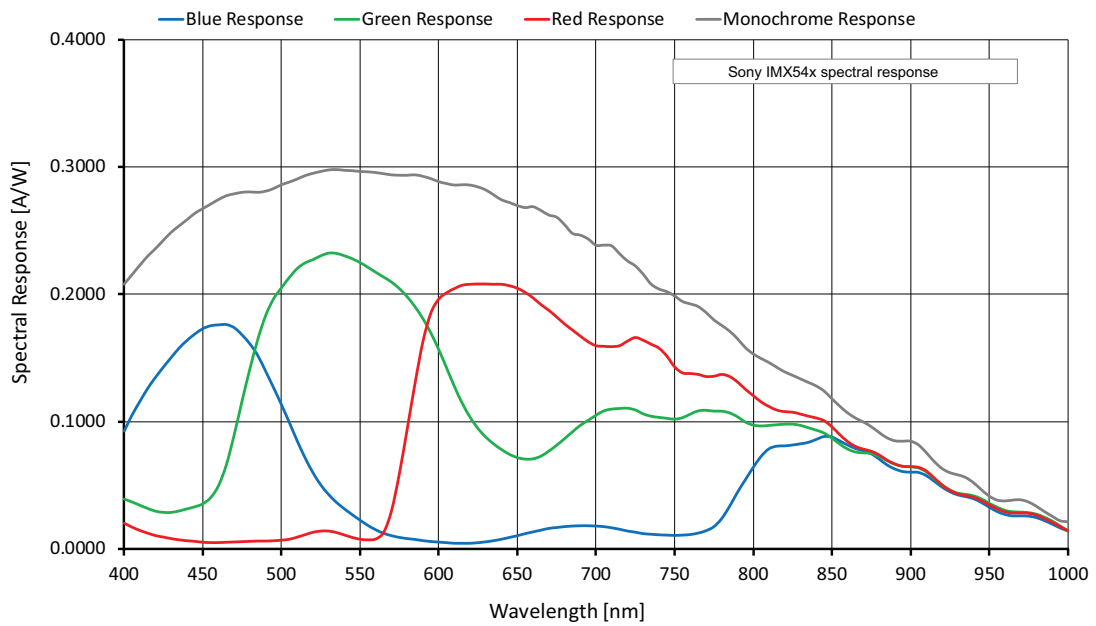

Figure 41: Alvium 1800 C-2040m/c (Sony IMX541) spectral response

## Frame rates with Cropping

Values were calculated for **typical operation** defined in [Frame rates with Cropping/ROI frame rates](#) on page 49.

Frame rates at maximum bandwidth calculates for 1.051 Gbps per lane. To reach the maximum frame rate available for typical operation, the bandwidth for image traffic is at 4 lanes with 4.204 Gbps.

Image format	Width [pixels]	Height [pixels]	ROI area [pixels]	Frame rate [fps]		
				4-lane	2-lane	1-lane
				4.204 Gbps	2.102 Gbps	1.051 Gbps
Full resolution	4,512	4,512	20,358,144	24	12	6
HXGA	4,096	3,072	12,582,912	37	19	10
UHD 4K	3,840	2,160	8,294,400	51	29	14
QSXGA	2,560	2,048	5,242,880	54	46	23
WQHD	2,560	1,440	3,686,400	75	64	32
QXGA	2,048	1,536	3,145,728	71		38
Full HD	1,920	1,080	2,073,600	97		55
UXGA	1,600	1,200	1,920,000	89		61
WXGA <sup>1</sup>	1,440	904 <sup>1</sup>	1,301,760	114		86
SXGA	1,280	1,024	1,310,720	102		87
HD 720	1,280	720	921,600	138		118
XGA	1,024	768	786,432	131		
SVGA	800	600	480,000	161		
VGA	640	480	307,200	193		
QVGA	320	240	76,800	314		
QQVGA	160	120	19,200	458		
Maximum × half	4,512	2,256	10,179,072	47	24	12
Maximum × minimum	4,512	16	72,192	591	354	196
Minimum × maximum	16	4,512	72,192	25		
Minimum × minimum	16	16	256	758		

<sup>1</sup> Instead of 1,440 × 900

Due to increments, some resolutions are not available. In this case, frame rates were calculated for the next available resolution.

Table 52: Alvium 1800 C-2040m/c ROI frame rates at maximum bandwidth

## Alvium 1800 C-2050m/c

Feature	Specification	
	1800 C-2050m (monochrome)	1800 C-2050c (color)
Sensor model	Sony IMX183	
Resolution	5376 (H) × 3672 (V); 19.7 MP	
Sensor type	CMOS	
Shutter type	Rolling shutter (RS)	
Sensor size	Type 1; 13.1 mm × 8.8 mm; 15.86 mm diagonal	
Pixel size	2.4 μm × 2.4 μm	
CRA	3 deg	
ADC	10-bit	
YUV color pixel formats	Not applicable	YUV422 8-bit (UYVY)
RGB color pixel formats	Default: RGB888 (RGB3)	
RAW pixel formats	RAW8 (GREY), RAW10 (Y10)	
Maximum image bit depth	10-bit	
Maximum frame rate	25 fps <sup>1</sup> , using 4 lanes	
Exposure time	13 μs to 10 s (4 lanes), 24 μs to 10 s (2 lanes), 45 μs to 10 s (1 lane)	
Image buffer (RAM)	256 KB	
Non-volatile memory (Flash)	1024 KB	
Gain	0 dB to 27 dB; 0.1 dB increments	
GPIOs	2 programmable GPIOs As direct inputs (push-pull): 0 to 5.5 VDC As direct outputs (push-pull): 0 to 3.3 VDC at 12 mA	
Power requirements	Power over MIPI CSI-2	
Power consumption (typical, at 5 VDC)	2.9 W	

<sup>1</sup>In triggered mode: 12 fps

Table 53: Alvium 1800 C-2050m/c specifications (sheet 1 of 2)

Feature	Specification			
	1800 C-2050m/c			
Operating temperature	Hardware option	Housing	Cooling areas <sup>2</sup>	Mainboard <sup>3</sup>
	Bare board <sup>4</sup>	Not applicable	+5 °C to +85 °C	+5 °C to +88 °C
	Open housing <sup>5</sup>	+5 °C to +65 °C		
Relative humidity	0% to 80% (non-condensing)			
Digital interface	MIPI CSI-2 D-PHY V1.1; 1, 2, or 4 lanes; maximum 1.125 Gbps per lane			
Camera controls	V4L2 controls (Video4Linux Access), Direct Register Access			

<sup>2</sup>See [Mounting the heat sink](#) on page 162.

<sup>3</sup>Output by **Device Temperature**

<sup>4</sup>Ensure that the sensor is operated in the temperature range specified by the manufacturer. For any questions, please visit [www.alliedvision.com/en/support](http://www.alliedvision.com/en/support).

<sup>5</sup>Temperature values must be observed for the housing **and** for the cooling areas.

Table 53: Alvium 1800 C-2050m/c specifications (sheet 2 of 2)

### Absolute QE

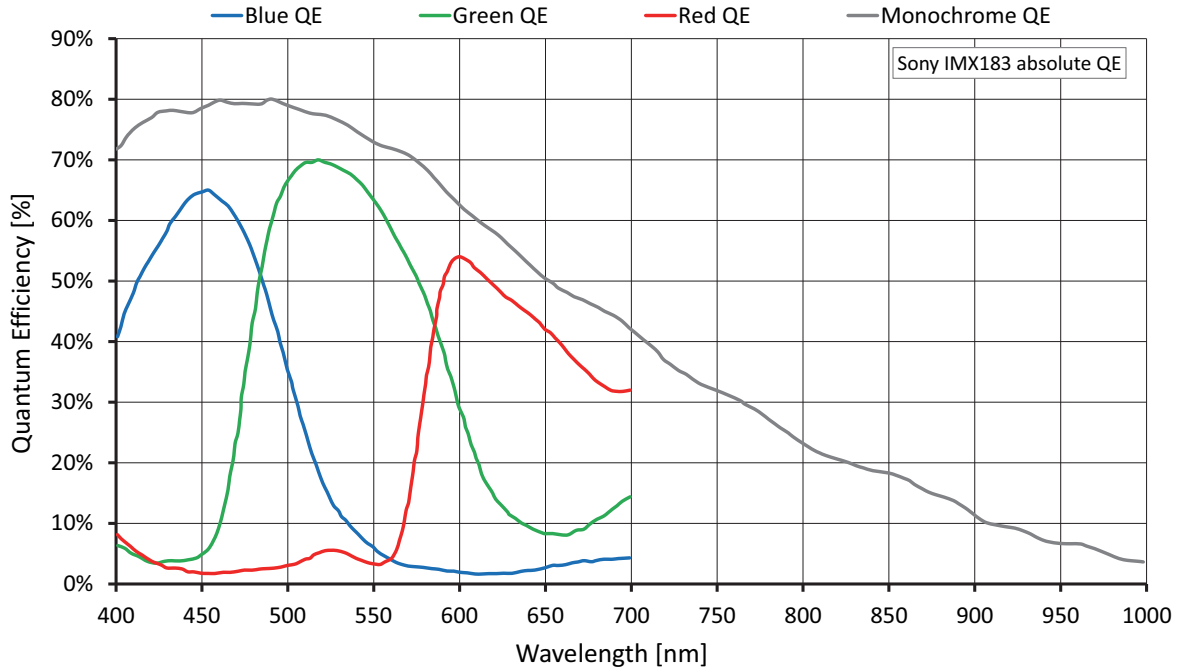

Figure 42: Alvium 1800 C-2050m/c (Sony IMX183) absolute QE

### Spectral response

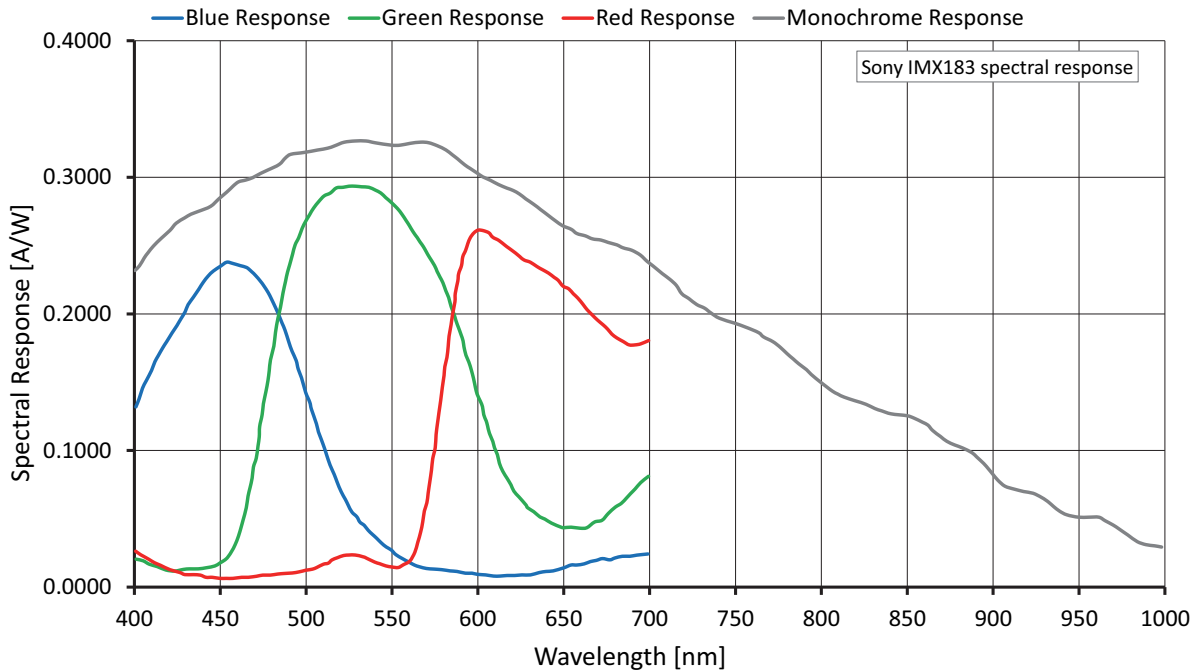

Figure 43: Alvium 1800 C-2050m/c (Sony IMX183) spectral response

## Frame rates with Cropping

Values were calculated for **typical operation** in rolling shutter (RS) mode, as defined in [Frame rates with Cropping/ROI frame rates](#) on page 49.

Frame rates at maximum bandwidth calculates for 1.051 Gbps per lane. To reach the maximum frame rate available for typical operation, the bandwidth for image traffic is at 4 lanes with 4.204 Gbps.

Image format	Width [pixels]	Height [pixels]	ROI area [pixels]	Frame rate [fps]					
				4-lane	2-lane	1-lane			
				4.204 Gbps	2.102 Gbps	1.051 Gbps			
Full resolution	5,376	3,672	19,740,672	25	12	6			
HXGA	4,096	3,072	12,582,912	29	15	7			
UHD 4K	3,840	2,160	8,294,400	41	21	10			
QSXGA	2,560	2,048	5,242,880	43	22	11			
WQHD	2,560	1,440	3,686,400	48	24	12			
QXGA	2,048	1,536	3,145,728						
Full HD	1,920	1,080	2,073,600						
UXGA	1,600	1,200	1,920,000						
WXGA <sup>1</sup>	1,440	904 <sup>1</sup>	1,301,760						
SXGA	1,280	1,024	1,310,720						
HD 720	1,280	720	921,600						
XGA	1,024	768	786,432						
SVGA	800	600	480,000						
VGA	640	480	307,200						
QVGA	320	240	76,800						
QQVGA	160	120	19,200						
Maximum × half <sup>2</sup>	5,376	1,840 <sup>2</sup>	9,891,840						
Maximum × minimum	5,376	16	86,016						
Minimum × maximum	16	3,672	58,752				25	12	6
Minimum × minimum	16	16	256				48	24	12

<sup>1</sup> Instead of 1,440 × 900  
<sup>2</sup> Instead of 5,376 × 1,836  
 Due to increments, some resolutions are not available. In this case, frame rates were calculated for the next available resolution.

Table 54: Alvium 1800 C-2050m/c ROI frame rates at maximum bandwidth



### Values in triggered mode

When rolling shutter cameras are operated in triggered mode, the values for maximum frame rate reached in free run mode are cut in half.

## Alvium 1800 C-2460m/c

Feature	Specification	
	1800 C-2460m (monochrome)	1800 C-2460c (color)
Sensor model	Sony IMX540-AAMJ	Sony IMX540-AAQJ
Resolution	5328 (H) × 4608 (V); 24.6 MP	
Sensor type	CMOS	
Shutter type	Global shutter (GS)	
Sensor size	Type 1.2; 14.60 mm × 12.63 mm; 19.3 mm diagonal	
Pixel size	2.74 μm × 2.74 μm	
CRA	0 deg	
ADC	12-bit	
YUV color pixel formats	Not applicable	YUV422 8-bit (UYVY)
RGB color pixel formats	Default: RGB888 (RGB3)	
RAW pixel formats	RAW8 (GREY), RAW10 (Y10), RAW12 (Y12)	
Maximum image bit depth	12-bit	
Maximum frame rate	20 fps, using 4 lanes	
Exposure time	166 μs to 10 s (4 lanes), 165 μs to 10 s (1 to 2 lanes)	
Image buffer (RAM)	256 KB	
Non-volatile memory (Flash)	1024 KB	
Gain	0 dB to 24 dB; 0.1 dB increments	
GPIOs	2 programmable GPIOs As direct inputs (push-pull): 0 to 5.5 VDC As direct outputs (push-pull): 0 to 3.3 VDC at 12 mA	
Power requirements	Power over MIPI CSI-2	
Power consumption (typical, at 5 VDC)	3.8 W	

Table 55: Alvium 1800 C-2460m/c specifications (sheet 1 of 2)

Feature	Specification			
	1800 C-2460m/c			
Operating temperature	Hardware option	Housing	Cooling areas <sup>1</sup>	Mainboard <sup>2</sup>
	Bare board <sup>3</sup>	Not applicable	+5 °C to +85 °C	+5 °C to +85 °C
	Open housing <sup>4</sup>	+5 °C to +65 °C		
Relative humidity	0% to 80% (non-condensing)			
Digital interface	MIPI CSI-2 D-PHY V1.1; 1, 2, or 4 lanes; maximum 1.125 Gbps per lane			
Camera controls	V4L2 controls (Video4Linux Access), Direct Register Access			
<sup>1</sup> See <a href="#">Mounting the heat sink</a> on page 162. <sup>2</sup> Output by <b>Device Temperature</b> <sup>3</sup> Ensure that the sensor is operated in the temperature range specified by the manufacturer. For any questions, please visit <a href="http://www.alliedvision.com/en/support">www.alliedvision.com/en/support</a> . <sup>4</sup> Temperature values must be observed for the housing <b>and</b> for the cooling areas.				

Table 55: Alvium 1800 C-2460m/c specifications (sheet 2 of 2)



## Absolute QE

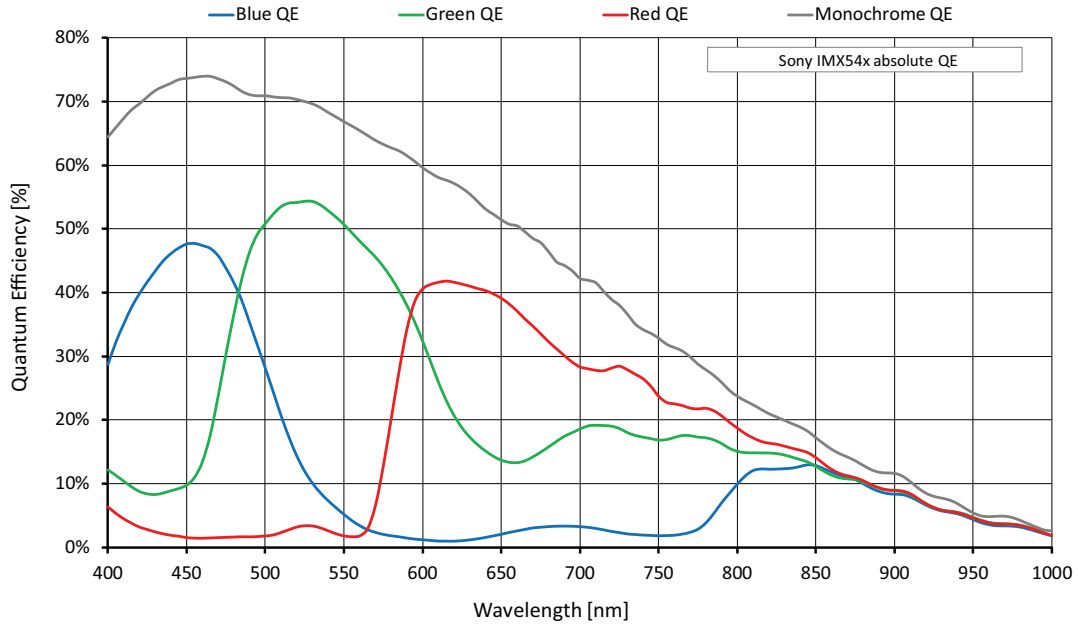

Figure 44: Alvium 1800 C-2460m/c (Sony IMX540) absolute QE

## Spectral response

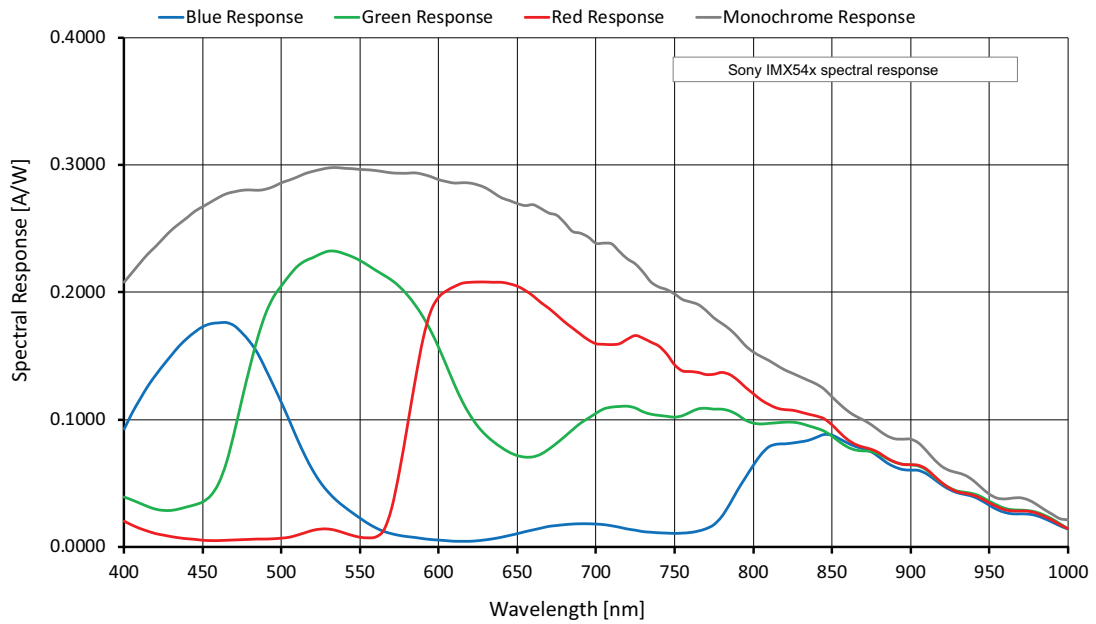

Figure 45: Alvium 1800 C-2460m/c (Sony IMX540) spectral response

## Frame rates with Cropping

Values were calculated for **typical operation** defined in [Frame rates with Cropping/ROI frame rates](#) on page 49.

Frame rates at maximum bandwidth calculates for 1.051 Gbps per lane. To reach the maximum frame rate available for typical operation, the bandwidth for image traffic is at 4 lanes with 4.204 Gbps.

Image format	Width [pixels]	Height [pixels]	ROI area [pixels]	Frame rate [fps]		
				4-lane	2-lane	1-lane
				4.204 Gbps	2.102 Gbps	1.051 Gbps
Full resolution	5,328	4,608	24,551,424	20	10	5
HSXGA	5,120	4,096	20,971,520	24	12	6
HXGA	4,096	3,072	12,582,912	31	19	10
UHD 4K	3,840	2,160	8,294,400	44	29	14
QSXGA	2,560	2,048	5,242,880	46		23
WQHD	2,560	1,440	3,686,400	64		32
QXGA	2,048	1,536	3,145,728	61		38
Full HD	1,920	1,080	2,073,600	83		56
UXGA	1,600	1,200	1,920,000	76		61
WXGA+	1,440	904	1,301,760	98		86
SXGA	1,280	1,024	1,310,720	88		87
HD 720	1,280	720	921,600	119		118
XGA	1,024	768	786,432	113		
SVGA	800	600	480,000	139		
VGA	640	480	307,200	166		
QVGA	320	240	76,800	272		
QQVGA	160	120	19,200	399		
Maximum × half	5,328	2,304	12,275,712	39	20	10
Maximum × minimum	5,328	16	85,248	514	305	168
Minimum × maximum	16	4,608	73,728	21		
Minimum × minimum	16	16	256	669		

<sup>1</sup> Instead of 1,440 × 900

Due to increments, some resolutions are not available. In this case, frame rates were calculated for the next available resolution.

Table 56: Alvium 1800 C-2460m/c ROI frame rates at maximum bandwidth

## White balance default

Alvium color cameras are balanced for neutral color reproduction with an illumination of 5000 °K (warm daylight). [Table 57](#) shows default values for the red and blue channel by model.

For different illuminations, use auto white balance or adapt the color channel values manually. See the descriptions in [Camera control](#) on page 153 for details.

Alvium model	Sensor model	Red channel value	Blue channel value
1500 C-050c	ON Semiconductor PYTHON 480	1.930	1.500
1500 C-120c	ON Semiconductor AR0135CS	1.760	1.650
1500 C-210c	ON Semiconductor AR0521SR	2.120	1.520
1500 C-500c	ON Semiconductor AR0521SR	2.120	1.520
1500 C-501c NIR	ON Semiconductor AR0522	1.500	1.770
1800 C-040c	Sony IMX287	2.360	2.030
1800 C-158c	Sony IMX273	2.355	2.100
1800 C-240c	Sony IMX392	2.355	2.100
1800 C-319c	Sony IMX265	2.355	2.100
1800 C-507c	Sony IMX264	2.355	2.100
1800 C-508c	Sony IMX250	2.355	2.100
1800 C-511c	Sony IMX547	2.870	2.000
1800 C-811c	Sony IMX546	2.870	2.000
1800 C-1236c	Sony IMX304	2.355	2.100
1800 C-1240c	Sony IMX226	2.620	1.810
1800 C-1242c	Sony IMX545	2.870	2.000
1800 C-1620c	Sony IMX542	2.870	2.000
1800 C-2040c	Sony IMX541	2.870	2.000
1800 C-2050c	Sony IMX183	2.660	1.830
1800 C-2460c	Sony IMX540	2.870	2.000

*Table 57: Alvium default values for color channels*

## Dimensions and mass

Bare board cameras	Specification
Dimensions (L × W × H [mm])	[Model specific] × 26 × 26
Mass [g]	10 g

Table 58: Bare board dimensions and mass

Open housing cameras	S-Mount	CS-Mount	C-Mount
Flange focal distance, optical [mm]	12.63	12.526	17.526
Thread	M12 mm × 0.5 mm	1"-32tpi UNS-2B	1"-32tpi UNS-2B
Maximum protrusion <sup>1</sup> [mm]	11.0	8.6	13.6
Body dimensions (L × W × H [mm])	20 × 29 × 29	21 × 29 × 29	26 × 29 × 29
Mass	40 g	40 g	40 g

<sup>1</sup>For details, see [Lens mounts and maximum protrusion](#).

Table 59: Housing dimensions and mass

## Technical drawings

Alvium CSI-2 cameras are available with the following housing options:

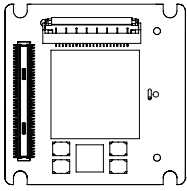
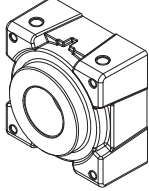
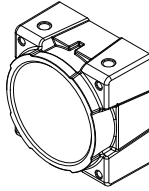
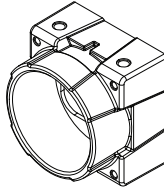
				
<b>Option</b>	Bare Board	Open Housing S-Mount	Open Housing CS-Mount	Open Housing C-Mount
<b>Page</b>	<a href="#">133</a>	<a href="#">135</a>	<a href="#">136</a>	<a href="#">137</a>

## Bare Board

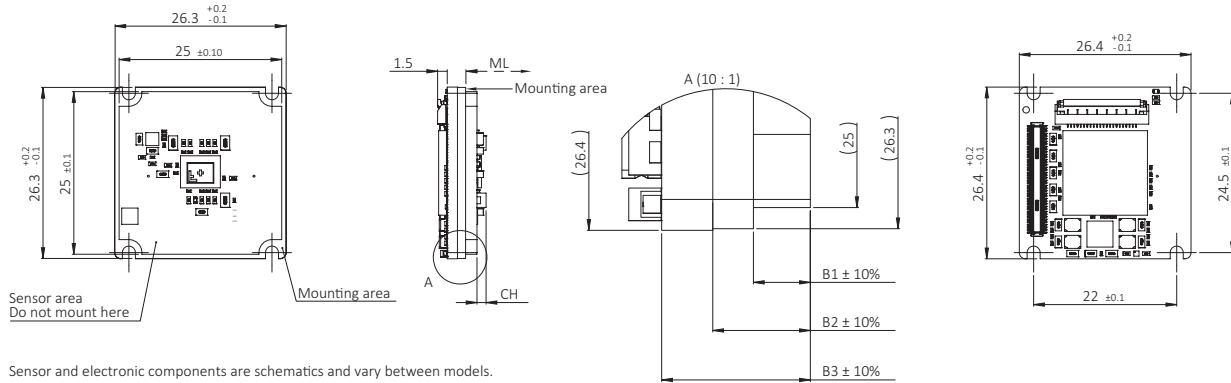

Figure 46: Bare Board dimensions

Dimensions that are common between different models are shown in [Figure 46](#), model specific dimensions are listed in [Table 60](#). **Mechanical length (ML)** defines the mechanical distance from the mounting area to the lens mount front flange, without optical filter. **Components height (CH)** relates to the electronic components with maximum height, sometimes the sensor.



### Mechanical length for S-Mount and CS-Mount

Mechanical length for other mounts is:

- CS-Mount: [C-Mount value] – 5 mm
- S-Mount: depending on your design.

Camera model	ML: Mechanical length* for C-Mount	CH: Components height, incl. the sensor	B1: Board thickness	B2: Board thickness	B3: Board thickness
Alvium 1500 C-050m/c	19.604 mm	1.40 mm	1.75 mm	3.00 mm	4.55 mm
Alvium 1500 C-120m/c	19.689 mm	1.44 mm	1.25 mm	2.40 mm	3.95 mm
Alvium 1500 C-210m/c	19.739 mm	1.67 mm	1.30 mm	2.40 mm	3.95 mm
Alvium 1500 C-500m/c	19.739 mm	1.67 mm	1.30 mm	2.40 mm	3.95 mm
Alvium 1500 C-501m/c NIR	19.739 mm	1.67 mm	1.30 mm	2.40 mm	3.95 mm
Alvium 1800 C-040m/c	19.897 mm	2.27 mm	1.20 mm	2.20 mm	3.75 mm
Alvium 1800 C-158m/c	19.897 mm	2.27 mm	1.20 mm	2.20 mm	3.75 mm
Alvium 1800 C-240m/c	19.929 mm	2.27 mm	1.25 mm	2.20 mm	3.75 mm
Alvium 1800 C-319m/c	19.929 mm	2.27 mm	1.25 mm	2.20 mm	3.75 mm
Alvium 1800 C-507m/c	19.929 mm	2.27 mm	1.25 mm	2.20 mm	3.75 mm
Alvium 1800 C-508m/c	19.929 mm	2.27 mm	1.25 mm	2.20 mm	3.75 mm
*Theoretical values					

Table 60: Bare Board model specific dimensions and nominal values (sheet 1 of 2)

Camera model	ML: Mechanical length* for C-Mount	CH: Components height, incl. the sensor	B1: Board thickness	B2: Board thickness	B3: Board thickness
Alvium 1800 C-511m/c	19.613 mm	2.88 mm	1.00 mm	2.20 mm	3.75 mm
Alvium 1800 C-811m/c	19.613 mm	2.88 mm	1.00 mm	2.20 mm	3.75 mm
Alvium 1800 C-1236m/c	19.829 mm	2.27 mm	1.15 mm	2.20 mm	3.75 mm
Alvium 1800 C-1240m/c	19.763 mm	2.20 mm	1.15 mm	2.20 mm	3.75 mm
Alvium 1800 C-1242m/c	19.613 mm	2.88 mm	1.00 mm	2.20 mm	3.75 mm
Alvium 1800 C-1620m/c	19.613 mm	2.88 mm	1.00 mm	2.20 mm	3.75 mm
Alvium 1800 C-2040m/c	19.613 mm	2.88 mm	1.00 mm	2.20 mm	3.75 mm
Alvium 1800 C-2050m/c	19.663 mm	2.87 mm	1.05 mm	2.20 mm	3.75 mm
Alvium 1800 C-2460m/c	19.613 mm	2.88 mm	1.00 mm	2.20 mm	3.75 mm
*Theoretical values					

Table 60: Bare Board model specific dimensions and nominal values (sheet 2 of 2)

## Open Housing S-Mount

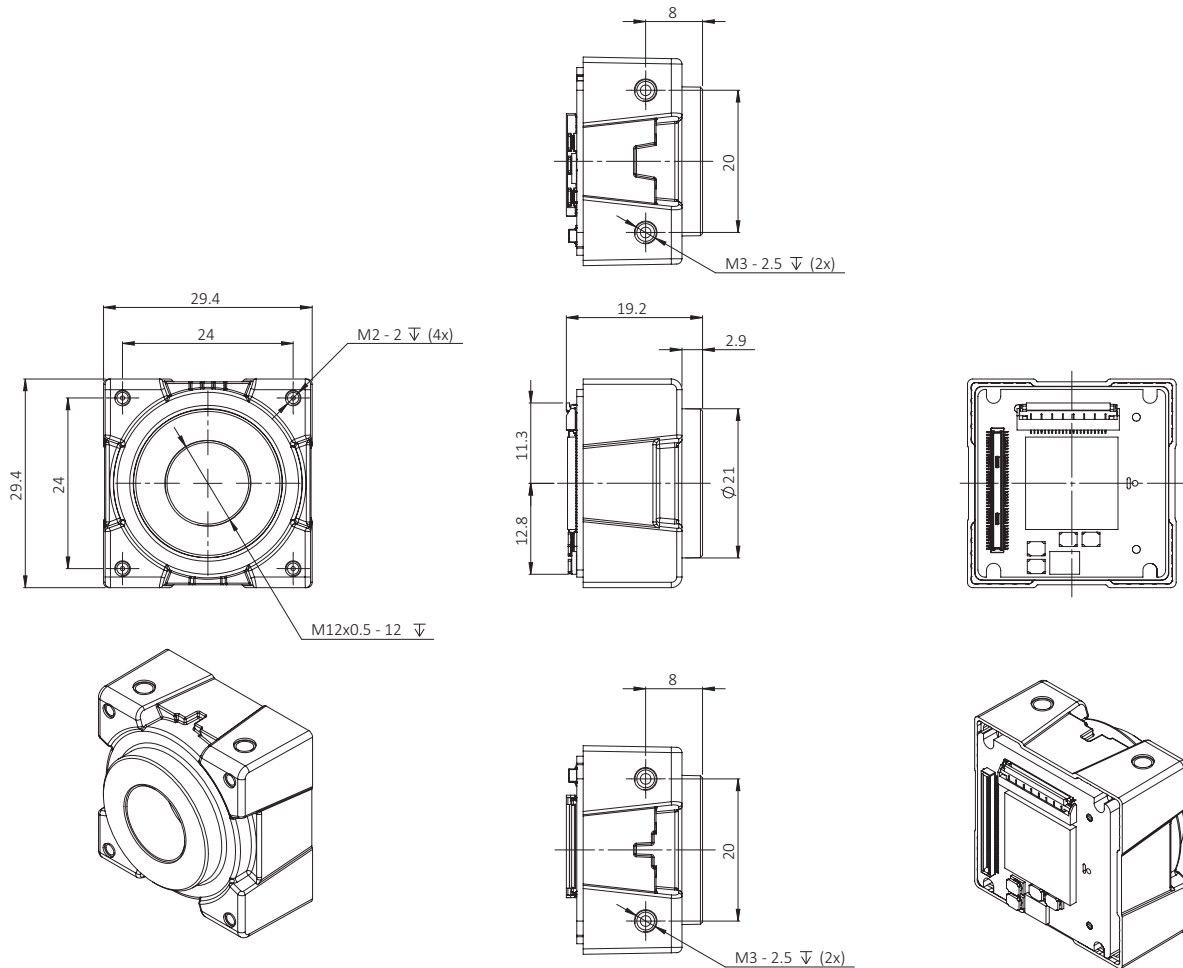

Figure 47: Open Housing S-Mount dimensions

## Open Housing CS-Mount

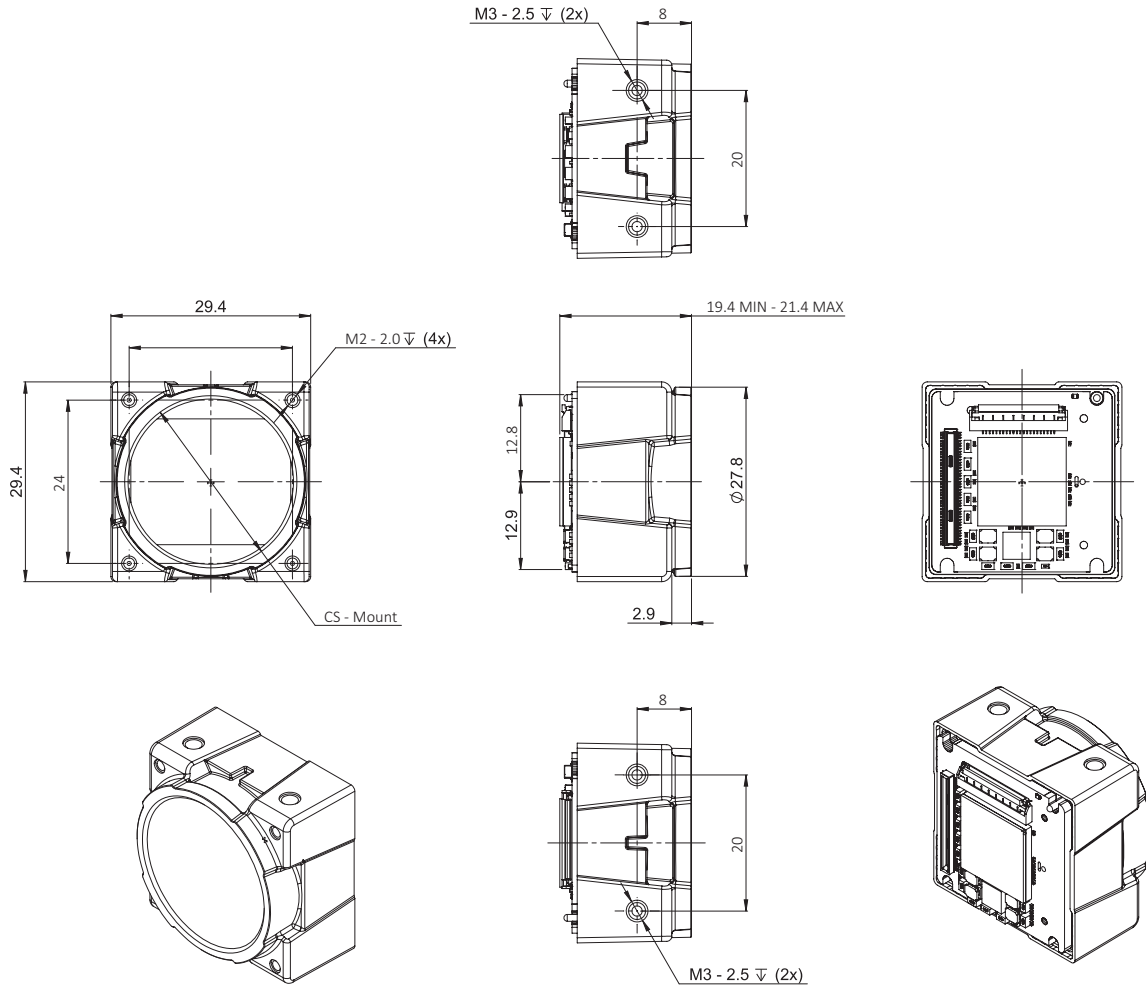

Figure 48: Open Housing CS-Mount dimensions



## Open Housing C-Mount

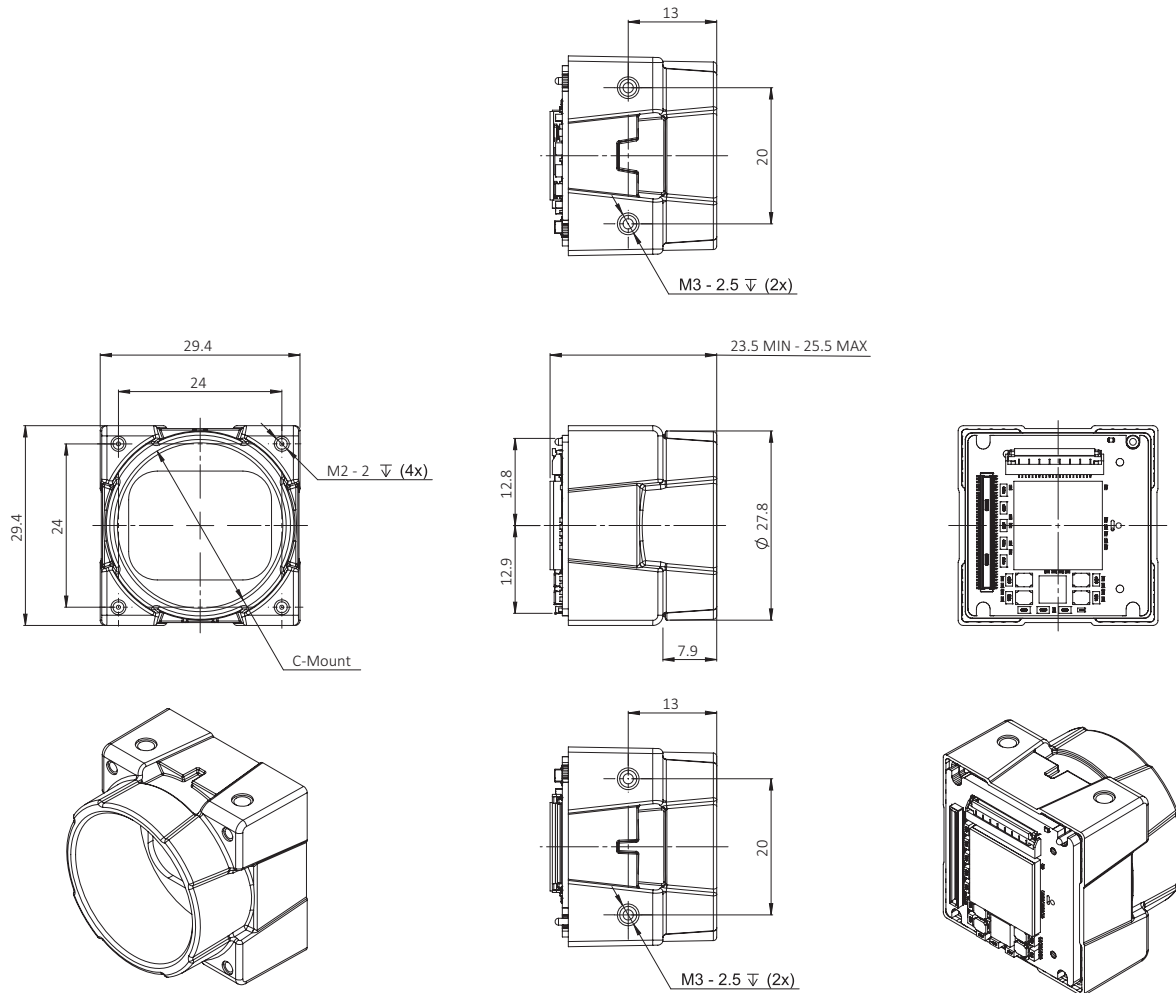

Figure 49: Open Housing C-Mount dimensions

# Lens mounts and maximum protrusion



## No need to readjust lens mounts

Alvium CSI-2 camera mounts are adjusted with high precision during manufacturing. Construction ensures permanent accuracy without need to readjust.

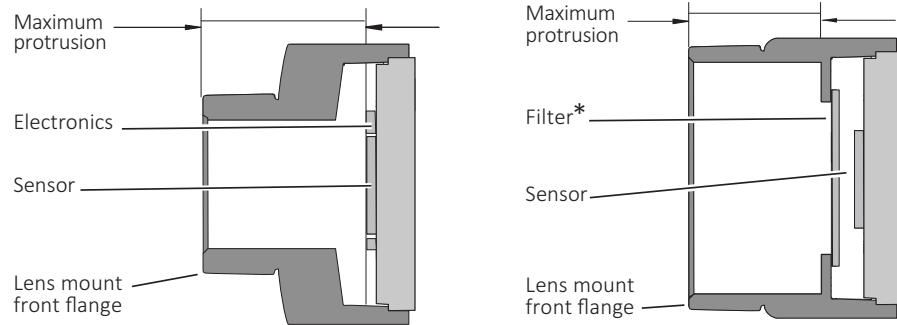

\*Only color models are equipped with an IR cut filter

Figure 50: Maximum protrusion S-Mount (left); CS-Mount and C-Mount (right)

Figure 50 shows schematics for maximum protrusion of lenses, Table 61 shows values for maximum protrusion.



### NOTICE

#### Damage to sensor, optics, or electronics by unsuitable lenses

The sensor, filter, lens, or electronics can be damaged if a lens exceeding maximum protrusion is mounted to the camera.

- Use lenses with less than the allowed maximum protrusion, see Table 61.
- See [Mounting the lens](#) on page 166.
- For S-Mount lenses, see [Mounting and focusing S-Mount lenses](#) on page 167.

Mount	Maximum protrusion
S-Mount	11.0 mm
CS-Mount	8.6 mm
C-Mount	13.6 mm

Table 61: Alvium CSI-2 cameras maximum protrusion

# IR cut filter

Table 62 shows which Alvium models are equipped with an IR cut filter. The filter is permanently installed and cannot be removed.

Color or monochrome model	Bare Board	S-Mount	CS-Mount	C-Mount
Color	No filter		Type Hoya C-5000 IR cut filter	
Monochrome	No filter			

Table 62: Optical filter availability

Cameras **without** IR cut filter have a higher sensitivity for low-light imaging. Moreover, spectral sensitivity is increased.

Cameras **with** IR cut filter are more accurate in reproduction of color, contrast, and sharpness, as the filter absorbs near-IR wavelengths. See Figure 51 for filter transmission.



### Spectral transmission values

The following curve shows typical transmission for type Hoya C-5000 IR cut filter. Values may vary slightly by filter lot.

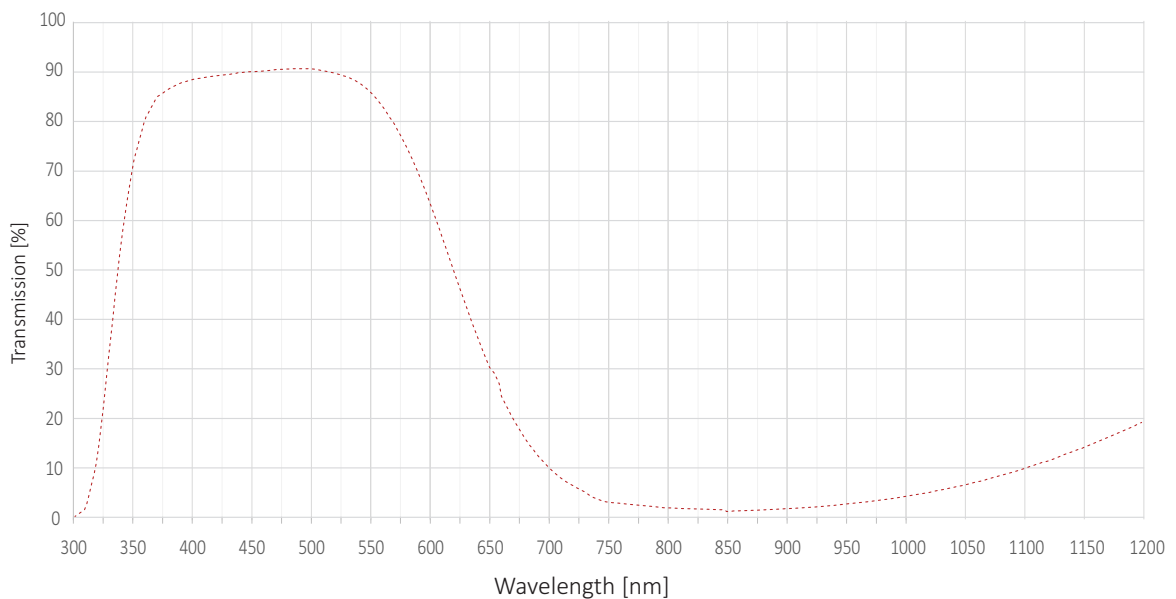

Figure 51: Type Hoya C-5000 IR cut filter spectral transmission



### S-Mount lenses with IR cut design

For improved image quality, we recommend using S-Mount lenses that are IR-optimized or that have IR cut coating. See the S-Mount Lenses User Guide at [www.alliedvision.com/fileadmin/content/documents/products/accessories/lenses/Allied\\_Vision/User\\_Guide/S-Mount-Lenses\\_User-Guide.pdf](http://www.alliedvision.com/fileadmin/content/documents/products/accessories/lenses/Allied_Vision/User_Guide/S-Mount-Lenses_User-Guide.pdf).

# Sensor position accuracy

## Sensor shift and rotation

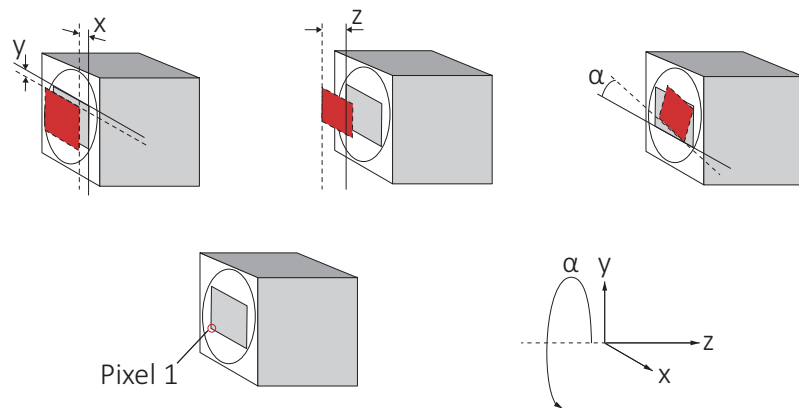

**Gray rectangle:** Reference sensor position    **Red rectangle:** Current position  
**Straight line:** Reference edge    **Dotted line:** Current reference edge

The orientation of the z-axis deviates from scientific conventions to define tolerances of the flange focal distance.

Figure 52: Sensor shift and rotation

The following table defines the manufacturing accuracy for sensor shift.

Criteria	Subject	Properties
Alignment method		Optical alignment of the photosensitive sensor area into the camera front module (lens mount front flange)
Reference Points	Sensor	Center of the pixel area (photo sensitive cells)
	Camera	Center of the lens mount
Accuracy	x/y-axis	$\pm 150 \mu\text{m}^1$ (sensor shift)
	z	0 to $-100 \mu\text{m}$ (optical back focal length)
	$\alpha$	$\pm 0.5 \text{ deg}$ (sensor rotation as the deviation from the parallel to the camera bottom)

<sup>1</sup>For Alvium 1800 C-2050 models, the complete offset is  $\pm 200 \mu\text{m}$ , common tolerances do not have to be added.

Table 63: Alvium CSI-2 cameras, criteria of sensor position accuracy

## Sensor tilt

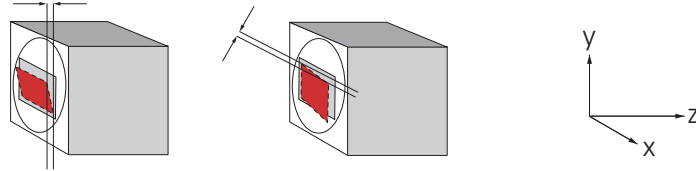

**Gray rectangle:** Reference sensor position    **Red rectangle:** Current position

Figure 53: Sensor tilt

The following table defines sensor tilt as the variance between highest and lowest pixel of a sensor along the z-axis, measured in micrometers.

Alvium model	Pixel size	Maximum tilt
Alvium 1500 C-050m/c	4.8 $\mu\text{m}$ $\times$ 4.8 $\mu\text{m}$	47 $\mu\text{m}$
Alvium 1500 C-120m/c	3.75 $\mu\text{m}$ $\times$ 3.75 $\mu\text{m}$	29 $\mu\text{m}$
Alvium 1500 C-210m/c	2.2 $\mu\text{m}$ $\times$ 2.2 $\mu\text{m}$	15 $\mu\text{m}$
Alvium 1500 C-500m/c	2.2 $\mu\text{m}$ $\times$ 2.2 $\mu\text{m}$	15 $\mu\text{m}$
Alvium 1500 C-501m/c NIR	2.2 $\mu\text{m}$ $\times$ 2.2 $\mu\text{m}$	15 $\mu\text{m}$
Alvium 1800 C-040m/c	6.9 $\mu\text{m}$ $\times$ 6.9 $\mu\text{m}$	95 $\mu\text{m}$
Alvium 1800 C-158m/c	3.45 $\mu\text{m}$ $\times$ 3.45 $\mu\text{m}$	24 $\mu\text{m}$
Alvium 1800 C-240m/c	3.45 $\mu\text{m}$ $\times$ 3.45 $\mu\text{m}$	24 $\mu\text{m}$
Alvium 1800 C-319m/c	3.45 $\mu\text{m}$ $\times$ 3.45 $\mu\text{m}$	24 $\mu\text{m}$
Alvium 1800 C-507m/c	3.45 $\mu\text{m}$ $\times$ 3.45 $\mu\text{m}$	24 $\mu\text{m}$
Alvium 1800 C-508m/c	3.45 $\mu\text{m}$ $\times$ 3.45 $\mu\text{m}$	24 $\mu\text{m}$
Alvium 1800 C-511m/c	2.74 $\mu\text{m}$ $\times$ 2.74 $\mu\text{m}$	18 $\mu\text{m}$
Alvium 1800 C-811m/c	2.74 $\mu\text{m}$ $\times$ 2.74 $\mu\text{m}$	18 $\mu\text{m}$
Alvium 1800 C-1236m/c	3.45 $\mu\text{m}$ $\times$ 3.45 $\mu\text{m}$	24 $\mu\text{m}$
Alvium 1800 C-1240m/c	2.74 $\mu\text{m}$ $\times$ 2.74 $\mu\text{m}$	18 $\mu\text{m}$
Alvium 1800 C-1242m/c	3.45 $\mu\text{m}$ $\times$ 3.45 $\mu\text{m}$	24 $\mu\text{m}$
Alvium 1800 C-1640m/c	2.74 $\mu\text{m}$ $\times$ 2.74 $\mu\text{m}$	18 $\mu\text{m}$
Alvium 1800 C-2040m/c	2.74 $\mu\text{m}$ $\times$ 2.74 $\mu\text{m}$	18 $\mu\text{m}$
Alvium 1800 C-2050m/c	2.4 $\mu\text{m}$ $\times$ 2.4 $\mu\text{m}$	12 $\mu\text{m}$
Alvium 1800 C-2460m/c	2.74 $\mu\text{m}$ $\times$ 2.74 $\mu\text{m}$	18 $\mu\text{m}$

Table 64: Sensor tilt

# Lenses: Focal length vs. field of view

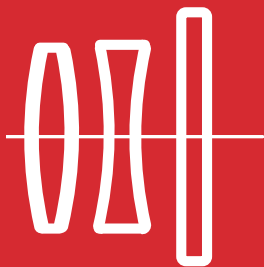

This chapter includes:

About this chapter .....	143
Optical vignetting with certain lenses .....	143
About S-Mount lenses .....	144
Focal length vs. field of view .....	144

## About this chapter

This section presents tables that list selected fields of view (FOV) depending on sensor size, distance, and focal length of the lens.

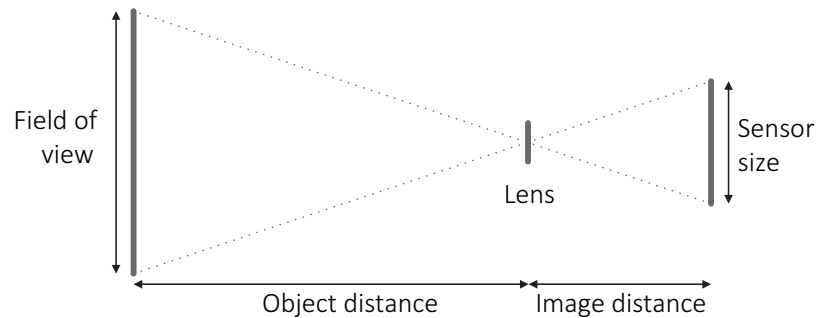

Figure 54: Parameters used in tables for focal length versus FOV



### Allied Vision S-Mount lenses

For technical data of Allied Vision S-Mount lenses with dedicated operating instructions, see the S-Mount Lenses User Guide at

[www.alliedvision.com/fileadmin/content/documents/products/accessories/lenses/Allied\\_Vision/User\\_Guide/S-Mount-Lenses\\_User-Guide.pdf](http://www.alliedvision.com/fileadmin/content/documents/products/accessories/lenses/Allied_Vision/User_Guide/S-Mount-Lenses_User-Guide.pdf).

## Parameters in tables

The distance to the object is measured from the first principal the plane of the lens to the object. For some lenses, manufacturers do not define the principal plane position. Production spread causes tolerances for all values, including actual focal lengths. Calculations apply for image reproduction without distortion. Therefore, values do not apply for fisheye lenses.

Please ask your Allied Vision Sales representative in case you need more information.

## Optical vignetting with certain lenses

Lenses with short focal lengths may show optical vignetting at the edges of the image. Microlenses on the sensor pixels can increase the effect.

For demanding applications, we suggest testing camera and lens to find a suitable setup. If you have questions, please contact your Allied Vision Sales representative.

## About S-Mount lenses

Alvium CSI-2 models with S-Mount have no filter. For typical applications, we recommend using S-Mount lenses with an integrated IR cut filter for a better image quality.

Read [Mounting and focusing S-Mount lenses](#) on page 167 to avoid damage when using S-Mount lenses.

## Focal length vs. field of view

### Alvium 1500 C-050m/c

Values apply to 1500 C-050m/c cameras (aspect ratio 1:1.34) with Type 1/3.6 (4.9 mm diagonal) sensors.

Focal length [mm]	Field of view (H × V [mm])	
	Object distance = 500 mm	Object distance = 1000 mm
2.8	689 × 517	1381 × 1036
3.6	535 × 401	1073 × 805
4.8	400 × 300	804 × 603
6	319 × 239	643 × 482
8	239 × 179	481 × 361
12	158 × 118	319 × 239
16	117 × 88	239 × 179
25	74 × 55	151 × 113

Table 65: Focal length versus field of view for Alvium 1500 C-050m/c



## Alvium 1500 C-120m/c

Values apply to 1500 C-120m/c cameras with Type 1/3 (6.0 mm diagonal) sensors.

Focal length [mm]	Field of view (H × V [mm])	
	Object distance = 500 mm	Object distance = 1000 mm
2.8	852 × 639	1709 × 1282
3.6	662 × 496	1329 × 996
4.8	495 × 371	995 × 746
6	395 × 296	795 × 596
8	295 × 221	595 × 446
12	195 × 146	395 × 296
16	145 × 109	295 × 221
25	91 × 68	187 × 140

Table 66: Focal length versus field of view for Alvium 1500 C-120m/c

## Alvium 1500 C-210m/c

Values apply to 1500 C-210m/c cameras (aspect ratio 1:1.75) with Type 1/3.6 (4.9 mm diagonal) sensors.

Focal length [mm]	Field of view (H × V in [mm])	
	Object distance = 500 mm	Object distance = 1000 mm
2.8	746 × 426	1496 × 855
3.6	579 × 331	1162 × 664
4.8	433 × 248	871 × 498
6	346 × 198	696 × 398
8	258 × 148	521 × 298
12	171 × 98	346 × 198
16	127 × 73	258 × 148
25	80 × 46	164 × 94

Table 67: Focal length versus field of view for Alvium 1500 C-210m/c

## Alvium 1500 C-500m/c, 1500 C-501m/c NIR

Values apply to 1500 C-500m/c and 1500 C-501m/c NIR cameras with Type 1/2.5 (7.1 mm diagonal) sensors.

Focal length [mm]	Field of view (H × V in [mm])	
	Object distance = 500 mm	Object distance = 1000 mm
2.8	1013 × 759	2031 × 1523
3.6	786 × 590	1578 × 1184
4.8	588 × 441	1182 × 887
6	469 × 352	945 × 709
8	351 × 263	707 × 530
12	232 × 174	469 × 352
16	172 × 129	351 × 263
25	108 × 81	222 × 167

Table 68: Focal length versus field of view for Alvium 1500 C-500m/c and 1500 C-501m/c NIR

## Alvium 1800 C-040m/c, 1800 C-158m/c

Values apply to 1800 C-040m/c and C-158m/c cameras with Type 1/2.9 (6.3 mm diagonal) sensors.

Focal length [mm]	Field of view (H × V [mm])	
	Object distance = 500 mm	Object distance = 1000 mm
2.8	892 × 667	1789 × 1337
3.6	693 × 518	1390 × 1039
4.8	518 × 387	1041 × 778
6	414 × 309	832 × 622
8	309 × 231	623 × 465
12	204 × 153	414 × 309
16	152 × 114	309 × 231
25	95 × 71	196 × 146

Table 69: Focal length versus field of view for Alvium 1800 C-040m/c and 1800 C-158m/c

## Alvium 1800 C-240m/c

Values apply to 1800 C-240m/c cameras with Type 1/2.3 (7.9 mm diagonal) sensors.

Focal length [mm]	Field of view (H × V in [mm])	
	Object distance = 500 mm	Object distance = 1000 mm
4.8	691 × 433	1389 × 871
6	552 × 346	1110 × 696
8	412 × 258	831 × 521
12	272 × 171	552 × 346
16	203 × 127	412 × 258
25	127 × 80	261 × 164
35	89 × 56	185 × 116
50	60 × 38	127 × 80

Table 70: Focal length versus field of view for Alvium 1800 C-240m/c

## Alvium 1800 C-319m/c

Values apply to 1800 C-319m/c cameras with Type 1/1.8 (8.9 mm diagonal) sensors.

Focal length [mm]	Field of view (H × V in [mm])	
	Object distance = 500 mm	Object distance = 1000 mm
4.8	735 × 550	1476 × 1104
6	586 × 439	1180 × 882
8	438 × 328	883 × 661
12	290 × 217	586 × 439
16	215 × 161	438 × 328
25	135 × 101	278 × 208
35	95 × 71	196 × 147
50	64 × 48	135 × 101

Table 71: Focal length versus field of view for Alvium 1800 C-319m/c

## Alvium 1800 C-507m/c, 1800 C-508m/c

Values apply to 1800 C-507m/c and 1800 C-508 cameras with Type 2/3 (11.1 mm diagonal) sensors.

Focal length [mm]	Field of view (H × V in [mm])	
	Object distance = 500 mm	Object distance = 1000 mm
6	700 × 584	1408 × 1175
8	523 × 436	1054 × 880
12	346 × 288	700 × 584
16	257 × 215	523 × 436
25	162 × 135	332 × 277
35	113 × 94	234 × 196
50	77 × 64	162 × 135

Table 72: Focal length versus field of view for Alvium 1800 C-507m/c and 1800 C-508m/c

## Alvium 1800 C-511m/c

Values apply to 1800 C-511m/c cameras with Type 1/1.8 (8.8 mm diagonal) sensors.

Focal length [mm]	Field of view (H × V in [mm])	
	Object distance = 500 mm	Object distance = 1000 mm
5	671 × 560	1348 × 1125
6	558 × 466	1122 × 937
8	417 × 348	840 × 701
12	275 × 230	558 × 466
16	205 × 171	417 × 348
25	129 × 107	264 × 221
35	90 × 75	187 × 156
50	61 × 51	129 × 107

Table 73: Focal length versus field of view for Alvium 1800 C-511m/c

## Alvium 1800 C-811m/c

Values apply to 1800 C-811m/c cameras Type 2/3 (11 mm diagonal) sensors.

Focal length [mm]	Field of view (H × V in [mm])	
	Object distance = 500 mm	Object distance = 1000 mm
5	773 × 773	1553 × 1553
6	642 × 642	1293 × 1293
8	480 × 480	968 × 968
12	317 × 317	642 × 642
16	236 × 236	480 × 480
25	148 × 148	304 × 304
35	104 × 104	215 × 215
50	70 × 70	148 × 148

Table 74: Focal length versus field of view for Alvium 1800 C-811m/c

## Alvium 1800 C-1236m/c

Values apply to 1800 C-1236m/c cameras with Type 1.1 (17.6 mm diagonal) sensors.

Focal length [mm]	Field of view (H × V in [mm])	
	Object distance = 500 mm	Object distance = 1000 mm
8	872 × 638	1759 × 1287
12	577 × 422	1168 × 854
16	429 × 314	872 × 638
25	270 × 197	553 × 405
35	188 × 138	391 × 286
50	128 × 93	270 × 197
75	80 × 59	175 × 128

Table 75: Focal length versus field of view for Alvium 1800 C-1236m/c

## Alvium 1800 C-1240m/c

Values apply to 1800 C-1240m/c cameras with Type 1/1.7 (9.33 mm diagonal) sensors.

Focal length [mm]	Field of view (H × V in [mm])	
	Object distance = 500 mm	Object distance = 1000 mm
4.8	763 × 578	1534 × 1161
6	609 × 461	1226 × 928
8	455 × 344	918 × 694
12	301 × 228	609 × 461
16	224 × 169	455 × 344
25	141 × 106	289 × 218
35	98 × 74	204 × 154
50	67 × 50	141 × 106

Table 76: Focal length versus field of view for Alvium 1800 C-1240m/c

## Alvium 1800 C-1242m/c

Values apply to 1800 C-1242m/c cameras with Type 1/1.1 (14 mm diagonal) sensors.

Focal length [mm]	Field of view (H × V in [mm])	
	Object distance = 500 mm	Object distance = 1000 mm
6	931 × 679	1874 × 1365
8	696 × 507	1403 × 1022
12	460 × 335	931 × 679
16	342 × 249	696 × 507
25	215 × 157	441 × 321
35	150 × 109	312 × 227
50	102 × 74	215 × 157
75	64 × 47	139 × 102

Table 77: Focal length versus field of view for Alvium 1800 C-1242m/c

## Alvium 1800 C-1620m/c

Values apply to 1800 C-1620m/c cameras with Type 1.1 (16.8mm diagonal) sensors.

Focal length [mm]	Field of view (H × V in [mm])	
	Object distance = 500 mm	Object distance = 1000 mm
5	1445 × 825	2905 × 1658
6	1202 × 686	2419 × 1380
8	898 × 512	1810 × 1033
12	594 × 339	1202 × 686
16	442 × 252	898 × 512
25	277 × 158	569 × 325
35	194 × 111	403 × 230
50	131 × 75	277 × 158
75	83 × 47	180 × 103

Table 78: Focal length versus field of view for Alvium 1800 C-1620m/c

## Alvium 1800 C-2040m/c

Values apply to 1800 C-2040m/c cameras with Type 1.1 (17.5 mm diagonal) sensors.

Focal length [mm]	Field of view (H × V in [mm])	
	Object distance = 500 mm	Object distance = 1000 mm
6	1018 × 1018	2048 × 2048
8	760 × 760	1533 × 1533
12	503 × 503	1018 × 1018
16	374 × 374	760 × 760
25	235 × 235	482 × 482
35	164 × 164	341 × 341
50	111 × 111	235 × 235
75	70 × 70	152 × 152
85	60 × 60	133 × 133

Table 79: Focal length versus field of view for Alvium 1800 C-2040m/c

## Alvium 1800 C-2050m/c

Values apply to 1800 C-2050m/c cameras with Type 1 (15.8 mm diagonal) sensors.

Focal length [mm]	Field of view (H × V in [mm])	
	Object distance = 500 mm	Object distance = 1000 mm
8	811 × 542	1636 × 1093
12	536 × 358	1086 × 726
16	399 × 267	811 × 542
25	251 × 167	514 × 344
35	175 × 117	364 × 243
50	119 × 79	251 × 167
75	75 × 50	163 × 109
85	64 × 43	142 × 95
100	53 × 35	119 × 79

Table 80: Focal length versus field of view for Alvium 1800 C-2050m/c

## Alvium 1800 C-2460m/c

Values apply to 1800 C-2460m/c cameras with Type 1.2 (19.3 mm diagonal) sensors.

Focal length [mm]	Field of view (H × V in [mm])	
	Object distance = 500 mm	Object distance = 1000 mm
8	898 × 776	1810 × 1566
12	594 × 513	1202 × 1040
16	442 × 382	898 × 776
25	277 × 240	569 × 492
35	194 × 168	403 × 348
50	131 × 114	277 × 240
75	83 × 72	180 × 156

Table 81: Focal length versus field of view for Alvium 1800 C-2460m/c



# Camera control





This chapter includes:

Access modes .....	154
V4L2 controls and register controls .....	156

## Access modes

The driver for Alvium CSI-2 cameras supports two different access modes to suit the various requirements of individual applications:

CSI-2 access mode	Description
Direct Register Access 	Controls the camera by reading from and writing to registers, using an embedded board or an FPGA. See the Direct Register Access Controls Reference document at <a href="http://www.alliedvision.com/en/support/technical-documentation/alvium-csi-2-documentation">www.alliedvision.com/en/support/technical-documentation/alvium-csi-2-documentation</a> .
Video4Linux Access 	Controls the camera by V4L2 controls, using the Allied Vision driver for CSI-2 cameras directly.  Existing PC-based machine vision applications can be scaled down to V4L2 on lean embedded systems, reducing power consumption and costs.

*Table 82: Access modes overview*

[Figure 55](#) on page 155 shows how cameras are controlled using the different access modes.

## Access modes data flow

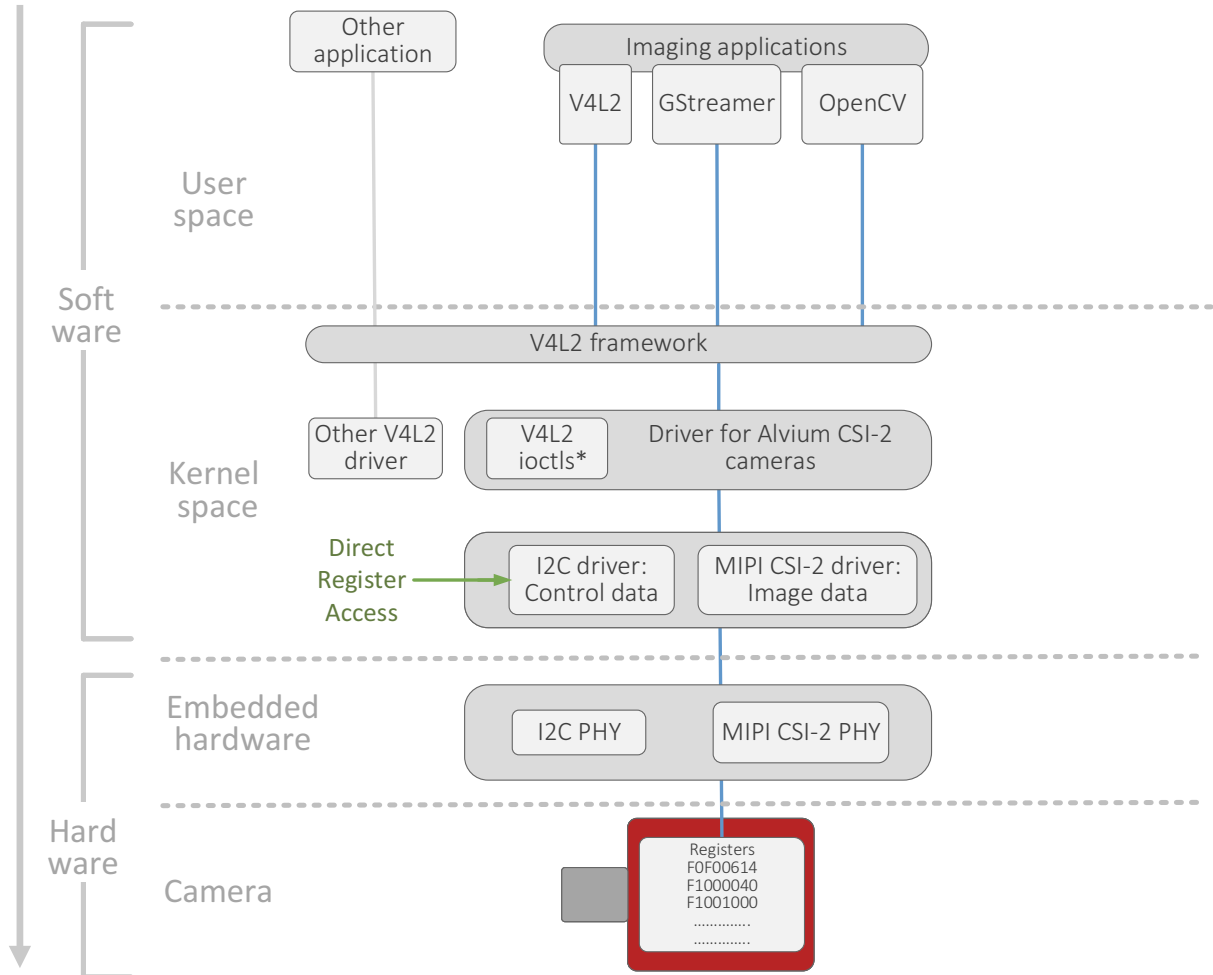

Figure 55: Camera control using the different access modes

**Direct Register Access:** Data is read from and written to registers directly.

**Video4Linux Access:** V4L2 controls registers.

## V4L2 controls and register controls

**Embedded applications** often use V4L2 controls provided with the Linux kernel to operate and configure the camera. **Machine vision applications** typically use GenICam SFNC features enabled by a transport layer communicating between a software development kit (SDK) and the interface driver. Current Alvium CSI-2 cameras do not support GenICam.



### V4L2 controls

Consider that V4L2 controls change through the Linux kernel development. The driver for Alvium CSI-2 cameras currently supports kernel 4.9.140. For embedded board adapters, see CSI-2 accessories at

[www.alliedvision.com/en/support/technical-documentation/alvium-csi-2-documentation](http://www.alliedvision.com/en/support/technical-documentation/alvium-csi-2-documentation).

For a description of V4L2 controls related to the **current kernel version**, see <https://linuxtv.org>.



### Reference for camera specific information

Almost every register control has an equivalent V4L2 control. For applications based on V4L2 Access, we recommend using the Direct Register Access Reference for camera specific information.

[www.alliedvision.com/en/support/technical-documentation/alvium-csi-2-documentation](http://www.alliedvision.com/en/support/technical-documentation/alvium-csi-2-documentation).

# Installing the hardware



This chapter includes:

Touching hot cameras .....	158
Scope of instructions .....	158
Bare board cameras .....	158
Connecting FPC cable and FPC connectors .....	160
Mounting the heat sink.....	162
Mounting the camera .....	163
Mounting the lens.....	166

## Touching hot cameras



### CAUTION

#### Risk of burns

A camera in operation can reach temperature levels which could cause burns.

- Wear protective gloves when you touch a camera that is heated up.
- Ensure proper cooling of the camera.

## Scope of instructions

### Software installation



#### Software downloads and documentation

This chapter describes hardware installation only. For information on supported Linux distributions and embedded boards, drivers, libraries, and programming examples, see [www.alliedvision.com/en/products/software/embedded-software-and-drivers](http://www.alliedvision.com/en/products/software/embedded-software-and-drivers).

### Hardware installation

This chapter instructs on using Alvim CSI-2 cameras safely and effectively. However, we cannot provide complete information. The MIPI CSI-2 standard does not specify electrical connections as extensively as USB or GigE standard. Therefore, instructions on camera connections can be general only.

## Bare board cameras

If you intend to design an application using bare board cameras, please consider:

- Aligning the sensor to the lens is extremely difficult and expensive. Therefore, we recommend you to do evaluation with housed cameras first.
- Bare board cameras are specialized components. We cannot give all data needed for any application in advance.
- Please let us partner with you for bare board camera applications to ensure a successful design.

## Serial numbers of Alvium® chips and bare board cameras

Bare board cameras do not have enough space for a label with all the required information. Therefore, they are shipped with a 25 mm × 25 mm sandwich label on the blister pack. This label shows, for example:

- Product code: 11500 for a 1500 C-210c Bare Board camera
- Alvium® chip SN (serial number): 183603543
- Camera SN (serial number): R7QW5 as digits and 2D code.

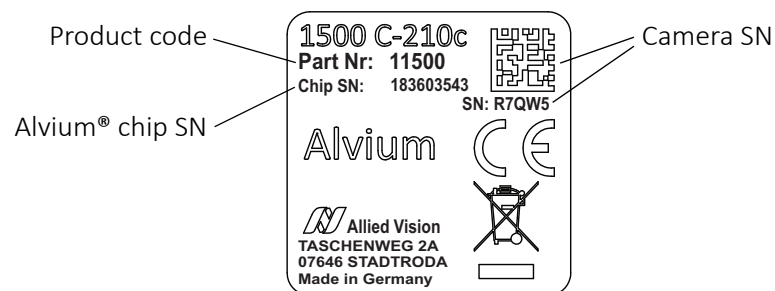

Figure 56: Sandwich label on blister packs shipped for bare board cameras

Before operating the camera, we recommend you to pull the sandwich label off the blister pack and stick it close to the camera.

If the label is lost, please read out with your smart phone the serial number of the Alvium® chip from the 2D code (a). With this number, we can look up the serial number of the camera in our database.

If your smart phone cannot read the 2D code: Combine the four digits (b) with the five digits (c). In the example, the serial number is 183603543.

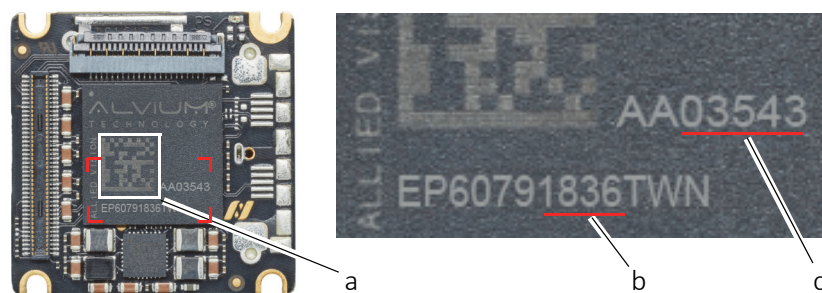

Figure 57: Alvium® chip imprint version 1 with detail view (right)

Future bare board cameras follow the convention shown in Figure 58. String (d) is the serial number, in the example, it is 205203543.

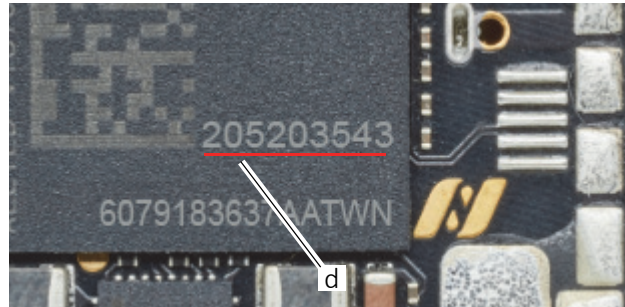

Figure 58: Alvimium® chip imprint version 2

## Connecting FPC cable and FPC connectors



### Connecting Alvimium CSI-2 cameras to embedded boards

- For evaluation, Allied Vision offers components to connect Alvimium CSI-2 cameras to embedded boards. **Adapter boards** provide common pinning and voltage for connections to the camera using **FPC cables**. See the Alvimium Cameras Accessory Guide at [www.alliedvision.com/en/support/technical-documentation/alvimium-csi-2-documentation](http://www.alliedvision.com/en/support/technical-documentation/alvimium-csi-2-documentation).
- If you want to design your own components to connect Alvimium CSI-2 cameras to embedded boards, contact your Allied Vision Sales representative or visit [www.alliedvision.com/en/support](http://www.alliedvision.com/en/support).

Figure 59 shows how the FPC cable connects to the FPC connector.

Follow the instructions to connect the FPC cable to the camera and to the embedded board.

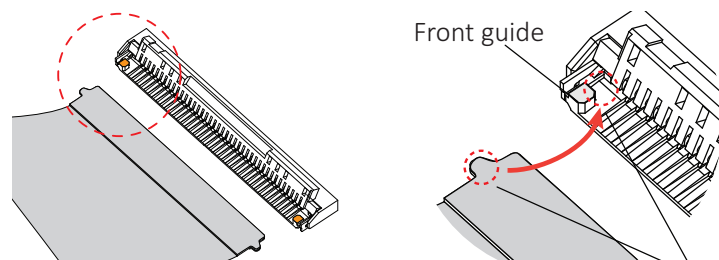

Figure 59: FPC cable and FPC connector (open position)

1. Opening the FPC connector:  
With your fingernail\*, flip the actuator to open position at 105 degrees to the PCB surface, see Figure 60.

\*Or a plastic tool, because metal tools can damage the actuator.

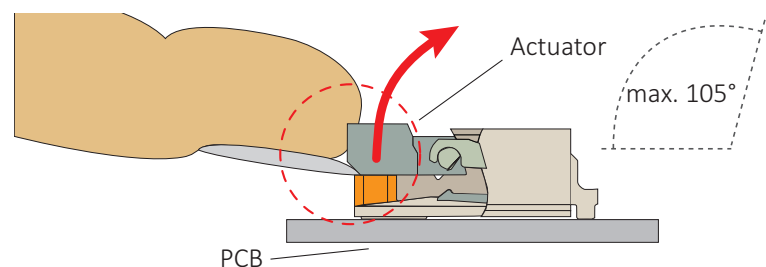

Figure 60: Opening the FPC connector



**NOTICE**
**Damage to the camera by reverse polarity**

If Alvium CSI-2 cameras are powered with reverse polarity, camera electronics is damaged.

- Before connecting camera power and I/O power, carefully read [FPC connector pin assignment](#) on page 172.
- Connect the cable as shown in this section.

Embedded  
board or  
adapter board

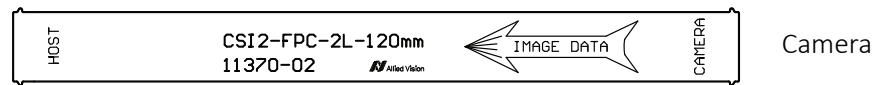

Figure 61: FPC cable and image data direction

2. **Ensuring proper cable direction between host and camera**, take the FPC cable with conductors facing the FPC connector conductors (see [Figure 62](#)).

3. Inserting the FPC cable:  
At a horizontal angle of 90 degrees to the connector's rear (see [Figure 62](#)) and at a vertical angle of 12 degrees to the PCB (see [Figure 63](#)), slowly insert the FPC cable into the actuator...

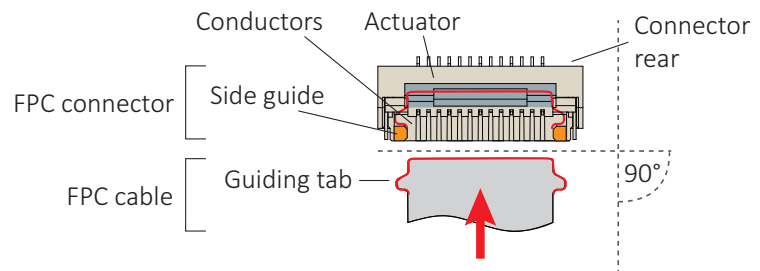

Figure 62: FPC cable and FPC connector

4. ...until cable guiding tabs are caught between connector rear and side guides (see [Figure 62](#)). Pull the cable slightly to ensure guiding tabs are properly engaged.
5. Holding the FPC cable in position, flap down the actuator to closed position (see [Figure 63](#)).

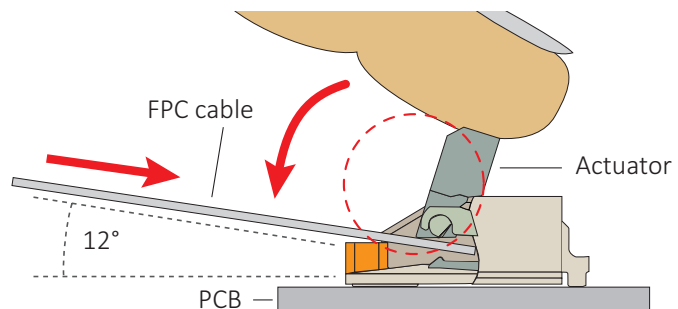

Figure 63: Engaging the FPC cable in the FPC connector

**NOTICE**
**Damage to FPC connectors**

A bended FPC cable can break the FPC connector's actuator.  
Provide sufficient strain relief at both ends of the cable.

# Mounting the heat sink

Keep the operating temperature in the specified range to enable best image quality and to protect the camera from damage. We recommend you to equip Alvium bare board and open housing cameras with heat sinks.



## Optimizing heat dissipation

For details, see the Optimum Heat Dissipation for Housed Alvium Cameras application note at [www.alliedvision.com/en/support/technical-documentation/alvium-csi-2-documentation](http://www.alliedvision.com/en/support/technical-documentation/alvium-csi-2-documentation).



### NOTICE

#### Damage to the camera by heat sinks mounted improperly

- Allow mechanical contact only at the cooling areas.
- Avoid any mechanical stress to the sensor and electronics area.
- Avoid short circuits of the electronics components.



### NOTICE

#### Damage to the sensor, filter, and lens by corrosive substances

Some conductive media for heat sinks contain corrosive substances that can damage optical surfaces of the sensor, filter, and lens.

- Cover the optical path of the camera when you apply heat sink compound or adhesive to prevent substances and fumes from damaging optical surfaces.
- Adhere to the instructions and safety notes provided by the manufacturer of the conductive media.



### NOTICE

#### Damage to camera electronics

Heat sinks can cause short circuits if they are not electrically isolated.

Avoid electrical contact between electronic components by unsuitable heat sinks and thermal conductive media.

Connect components in the **cooling areas** (blue areas in [Figure 64](#)) to a heat sink, following the instructions of the manufacturer of the heat sink and the thermal conductive media.

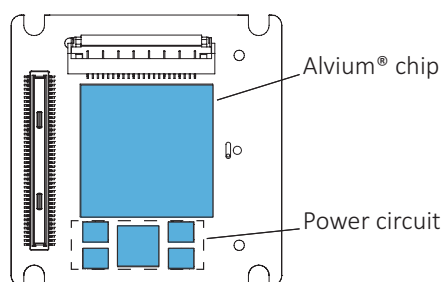

Figure 64: Cooling areas for Alvium CSI-2 bare board cameras

# Mounting the camera



## CAUTION

### Injury by falling cameras or lenses

A falling camera or lens can cause injury.

- Ensure proper mounting of cameras and lenses, especially for dynamic applications.
- Mount cameras as described in the instructions.
- Always make sure the mounting threads are intact.
- Fasten screws with maximum torque, using the entire thread engagement. For less thread engagement, see [Adapting maximum torque values](#) on page 165.
- We recommend you to apply thread locking.
- Use a lens support for heavy lenses.

## Mounting bare board cameras



### Heat dissipation and electromagnetic compatibility for bare board cameras

For heat dissipation, see the Optimum Heat Dissipation for Housed Alvium Cameras application note.

For electromagnetic compatibility, see the Electromagnetic Compatibility for Open Housing Alvium Cameras application note.

See [www.alliedvision.com/en/support/technical-documentation/alvium-csi-2-documentation](http://www.alliedvision.com/en/support/technical-documentation/alvium-csi-2-documentation).



## NOTICE

### Damage to the camera by improper mounting

- Allow mechanical contact only at the mounting area.
- Avoid any mechanical stress to the sensor and the electronics area.
- Avoid short circuits of the electronics components.
- Give 2 mm minimum clearance above board components.
- Tighten screws at 0.1 Nm maximum torque.

Schematic drawings in [Figure 65](#) show the Alvium CSI-2 bare board camera. Only the mounting area (gray) can be used for mounting. The sensor and electronics area (red) must not be touched nor put at mechanical stress.

a = Mounting hole | b = Mounting hole and chassis ground

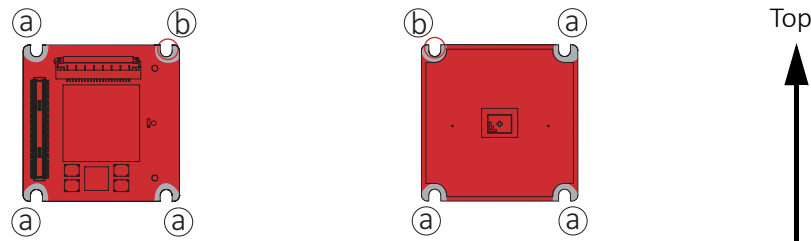
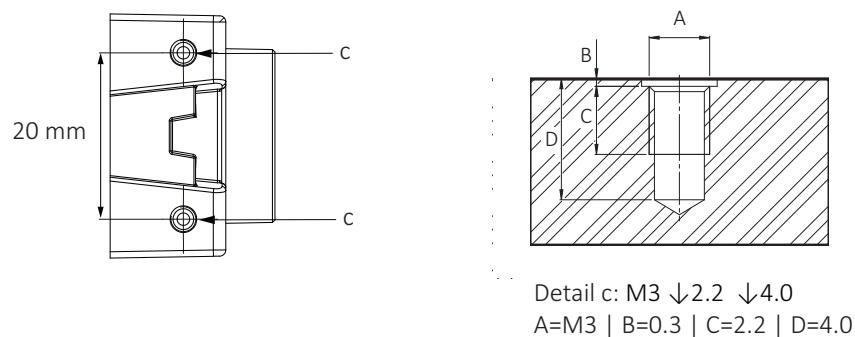

*Figure 65: Mounting area of Alvium CSI-2 bare board cameras connector side (left); sensor side (right)*

Mount the bare board with four M2 screws at 0.1 Nm maximum torque.

## Mounting open housing cameras

### Bottom or top mounting



*Figure 66: Top and bottom and mounting threads (c)*

**The maximum torque value applies only if the entire thread engagement is used.** For other values, see [Adapting maximum torque values](#) on page 165.

1. Mount the camera to the base using suitable M3 screws at 0.51 Nm maximum torque for a thread engagement (C) of 2.2 mm between screws and mounting threads, see [Figure 66](#). For technical drawings, see [Dimensions and mass](#) on page 132.
2. Continue with [Mounting the lens](#) on page 166.

## Front mounting

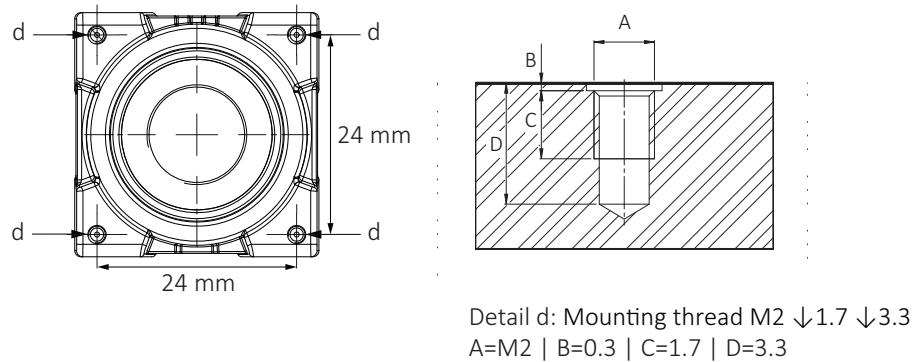

Figure 67: Camera front with mounting threads (d)

**The maximum torque value applies only if the entire thread engagement is used.** For other values, see [Adapting maximum torque values](#) on page 165.

1. Mount the camera to the base using suitable M2 screws at 0.17 Nm maximum torque for a thread engagement (C) of 1.7 mm between screws and mounting threads, see [Figure 67](#). For technical drawings, see [Dimensions and mass](#) on page 132.  
 We recommend you to additionally use bottom and top mounting threads for a more solid connection.
2. Continue with [Mounting the lens](#) on page 166.

## Adapting maximum torque values

The total bolt length composes of the mounting holes length and the height of your mounting base.

For using less than the stated length of thread engagement, calculate maximum torque as follows:

$$\frac{\text{Current length of thread engagement}}{\text{Length of thread engagement in table}} \times \text{Torque in table} = \text{Current torque}$$

Example for a length of thread engagement of **1.4 mm** instead of 1.7 mm:

$$\mathbf{1.4\ mm / 1.7\ mm \times 0.17\ Nm = 0.14\ Nm}$$

Thread group	Thread position	Thread type	Total protrusion	Length of thread engagement	Maximum torque
d	Front mounting	M2	2 mm	1.7 mm	0.17 Nm
d	Front mounting	M2	2 mm	<b>1.4 mm</b>	<b>0.14 Nm</b>

Table 83: Adjusting maximum torque values

To ensure that the bolts do not become loose over time, we recommend you to use means for securing bolts, such as screw locking varnish.



#### Tripod adapter

For more information, see the Alvium Cameras Accessory Guide at [www.alliedvision.com/en/support/technical-documentation/alvium-csi-2-documentation](http://www.alliedvision.com/en/support/technical-documentation/alvium-csi-2-documentation).

## Mounting the lens

Observe the following notes before you mount lenses to Alvium CSI-2 cameras.



### CAUTION

#### Injury by falling cameras or lenses

A falling camera or lens can cause injury.

- Ensure proper mounting of cameras and lenses, especially for dynamic applications.
- Mount cameras as described in the instructions.
- Use a lens support for heavy lenses.



### CAUTION

#### Risk of cuts by sharp edges of lens mounts

The threads of the lens mount can have sharp edges.

Be careful when mounting or unmounting lenses.



### NOTICE

#### Damage to sensor, optics, or electronics by unsuitable lenses

The sensor, filter, lens, or electronics can be damaged if a lens exceeding maximum protrusion is mounted to the camera.

- Use lenses only up to the specified maximum protrusion, see [Lens mounts and maximum protrusion](#) on page 138.
- S-Mount lenses must be screwed into the camera at less than maximum protrusion (11.0 mm), see [Mounting and focusing S-Mount lenses](#) on page 167.
- Avoid short S-Mount lenses falling into the camera.

## Mounting and focusing S-Mount lenses



### Allied Vision S-Mount lenses

For technical data of Allied Vision S-Mount lenses with dedicated operating instructions, see the S-Mount Lenses User Guide at [www.alliedvision.com/fileadmin/content/documents/products/accessories/lenses/Allied\\_Vision/User\\_Guide/S-Mount-Lenses\\_User-Guide.pdf](http://www.alliedvision.com/fileadmin/content/documents/products/accessories/lenses/Allied_Vision/User_Guide/S-Mount-Lenses_User-Guide.pdf).

This section instructs how to use S-Mount lenses with your camera safely.

S-Mount lenses are screwed into the mount to adjust focus. Vibration moves lenses out of position. Several techniques can be used to fasten S-Mount lenses in focus. We recommend using fixing nuts. See instructions in this section.



### Drawings and fixing nuts

Drawings in the instructions are schematic.

Several manufacturers offer various types of S-Mount fixing nuts. The type shown in the instructions drawings is an example.

We recommend using pinch nose pliers to tighten fixing nuts.

Figure 68 shows how fixing nuts lock S-Mount lenses.  
Follow the instructions to lock the lens in focus position.

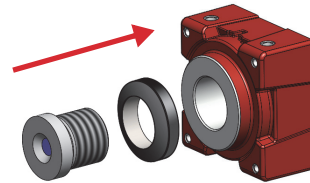

Figure 68: Fixing nut locking an S-Mount lens

**NOTICE**
**Damage to sensor, optics, or electronics by improper handling**

If an S-Mount lens is screwed against the sensor or electronics, sensor, lens, or electronics can be damaged.

- Screw in the lens at less than 11.0 mm maximum protrusion.
- Follow the instructions carefully.

**Determining the allowed range for the position of the lens**

1. Measure the length of the lens.
2. Calculate:  $a = c - b$   
 a: length of the mounted lens, measured from lens mount front flange  
 b: maximum protrusion (11.0mm)  
 c: length of the lens

See [Lens mounts and maximum protrusion](#) on page 138.

3. Set a gauge to the length of (a).

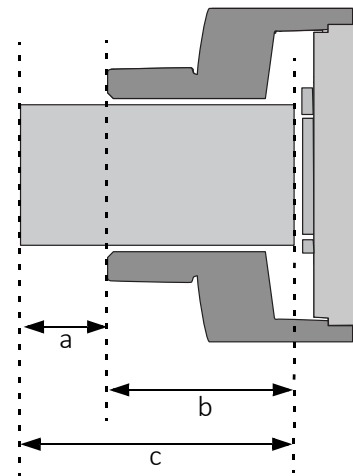

Figure 69: S-Mount lens and protrusion

**Mounting the fixing nut to the lens**

4. Screw the fixing nut clockwise onto the lens until you can hold the front part (d) of the lens with your finger tips.

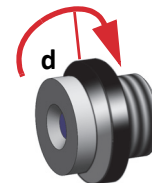

Figure 70: Lens and fixing nut

**Focusing the lens**

5. **Checking (a) with a gauge**, slowly screw the lens clockwise into the lens mount until the image is roughly in focus.
6. Slowly screw in and unscrew the lens until you have found the most accurate focus.

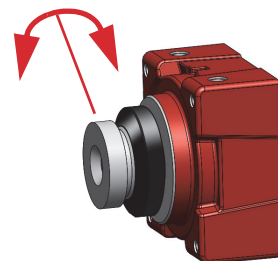

Figure 71: Adjusting focus



**NOTICE**
**Damage to lens threads and fixing nut by excessive force**

If the fixing nut is screwed with too much force, threads are worn out and the lens cannot be locked anymore.

Screw fixing nuts hand tight to keep the lens in a fixed position.

**Locking focus**

Pinch nose pliers are used to screw the fixing nut:

7. Holding the lens in position with one hand, screw the fixing nut clockwise against the lens mount until you feel the lens is locked.

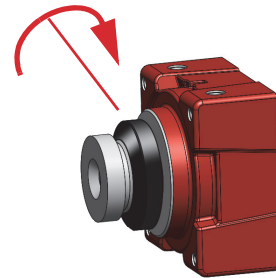

Figure 72: Tightening the fixing nut

**Checking focus is set and locked properly**

8. Check No.1: Try to rotate the lens with little force in both directions to ensure the lens is safely locked in position.

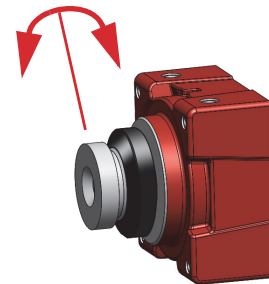

Figure 73: Checking lens is safely locked

9. Check No. 2: S-Mount thread allows a slightly tilted lens position. In this case, focus for a common object plane varies over the image plane.

**If focus is constant** over the image plane, you are done.

**If focus varies** over the image plane, the lens is tilted. Continue with 10.

10. Loosen the fixing nut.

11. Continue with 6.

The lens is locked in focus and ready for operation.

# Camera interfaces

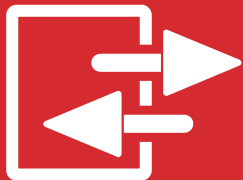

This chapter includes:

Recommended accessories .....	171
Back panel .....	171
FPC connector pin assignment .....	172
Non-isolated, programmable GPIOs .....	174
Status LED.....	176

## Recommended accessories



### Compatible electronics accessories

For more information, see the Alvium Cameras Accessory Guide at [www.alliedvision.com/en/support/technical-documentation/alvium-csi-2-documentation](http://www.alliedvision.com/en/support/technical-documentation/alvium-csi-2-documentation).

## Back panel

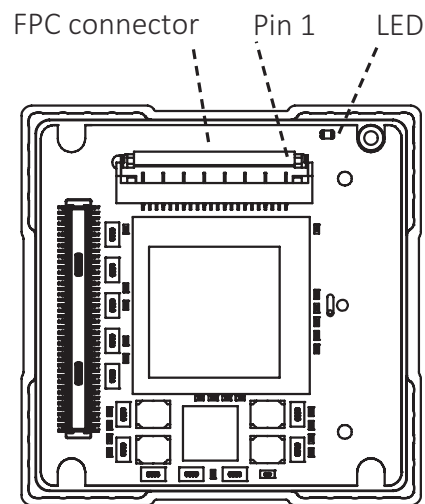

Figure 74: Camera back panel

For connector pin assignment, see [FPC connector pin assignment](#) on page 172.

# FPC connector pin assignment

Alvium CSI-2 cameras have a 22-pin Hirose FH55-22S-0.5SH connector.



## NOTICE

### Damage to the camera by reverse polarity

If Alvium CSI-2 cameras or camera I/Os are powered with reverse polarity, camera electronics can be damaged.

Observe polarity for camera and I/O power.



### More information on Hirose FH55-22S-0.5SH connector

For technical data and more instructions on the Hirose FH55-22S-0.5SH connector, see the manufacturer data sheet at [www.hirose.com](http://www.hirose.com).

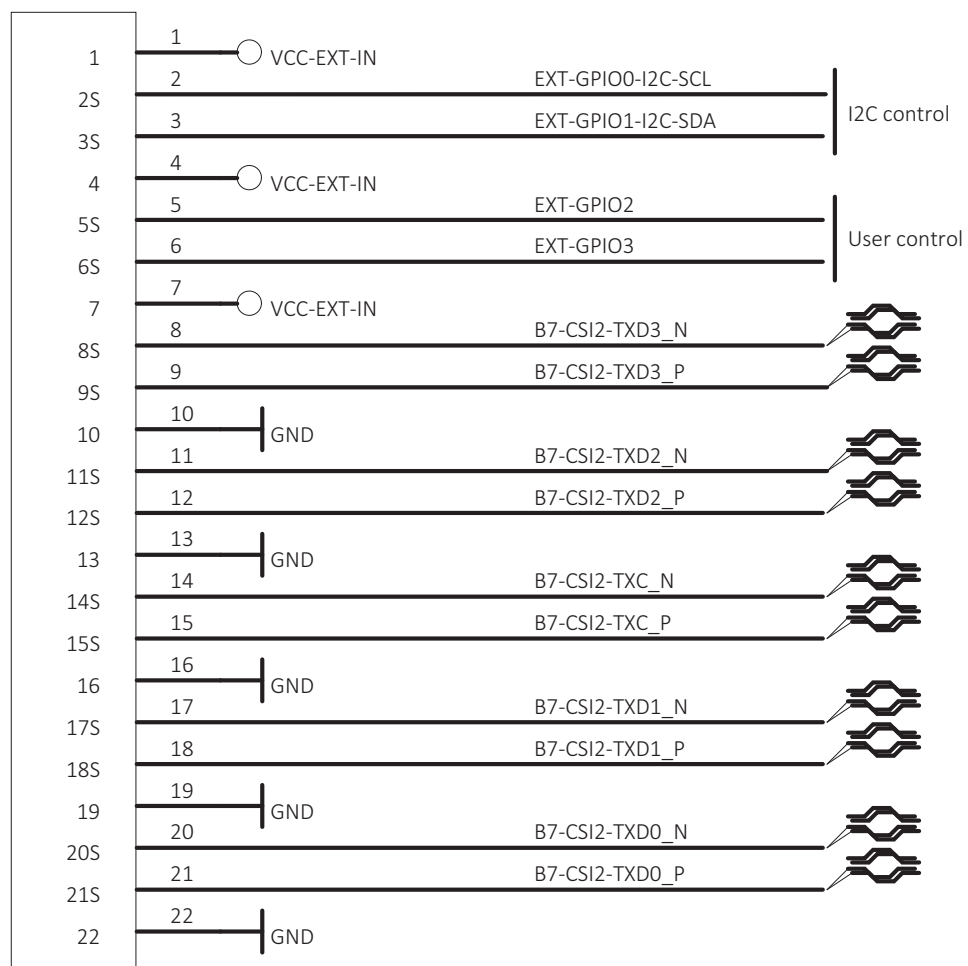

Figure 75: Camera Hirose FH55-22S-0.5SH connector pin assignment

Pin	Signal	Direction	Level	Description
1	VCC-EXT-IN	PWR IN	4.5 to 5.5 VDC	Power supply voltage Maximum input current: 1.5 A
2	EXT-GPIO 0	IN/OUT	U <sub>in</sub> (low) = -0.3 to 0.8 VDC U <sub>in</sub> (high) = 2.0 to 5.5 VDC U <sub>out</sub> (low) = 0 to 0.4 VDC U <sub>out</sub> (high) = 2.4 to 3.3 VDC at 12 mA	I2C Control Internal pull-up resistor: 33 to 63 kΩ
3	EXT-GPIO 1	IN/OUT	See Pin 2, EXT-GPIO 0	
4	VCC-EXT-IN	PWR IN	4.5 to 5.5 VDC	Power supply voltage Maximum input current: 1.5 A
5	EXT-GPIO 2	IN/OUT	U <sub>in</sub> (low) = -0.3 to 0.8 VDC U <sub>in</sub> (high) = 2.0 to 5.5 VDC U <sub>out</sub> (low) = 0 to 0.4 VDC U <sub>out</sub> (high) = 2.4 to 3.3 VDC at 12 mA	GPIO Internal pull-up resistor: 33 to 63 kΩ
6	EXT-GPIO 3	IN/OUT	See Pin 5, EXT-GPIO 2	
7	VCC-EXT-IN	PWR IN	4.5 to 5.5 VDC	Power supply voltage Maximum input current: 1.5 A
8	CSI2-TXD3_N	OUT	According to MIPI CSI-2 D-PHY V1.1	CSI-2 TX data lane 3 negative rail
9	CSI2-TXD3_P	OUT	According to MIPI CSI-2 D-PHY V1.1	CSI-2 TX data lane 3 positive rail
10	GND	PWR	0 VDC	Power supply ground
11	CSI2-TXD2_N	OUT	According to MIPI CSI-2 D-PHY V1.1	CSI-2 TX data lane 2 negative rail
12	CSI2-TXD2_P	OUT	According to MIPI CSI-2 D-PHY V1.1	CSI-2 TX data lane 2 positive rail
13	GND	PWR	0 VDC	Power supply ground
14	CSI2-TXC_N	OUT	According to MIPI CSI-2 D-PHY V1.1	CSI-2 TX clock lane negative rail
15	CSI2-TXC_P	OUT	According to MIPI CSI-2 D-PHY V1.1	CSI-2 TX clock lane positive rail
16	GND	PWR	0 VDC	Power supply ground
17	CSI2-TXD1_N	OUT	According to MIPI CSI-2 D-PHY V1.1	CSI-2 TX data lane 1 negative rail
18	CSI2-TXD1_P	OUT	According to MIPI CSI-2 D-PHY V1.1	CSI-2 TX data lane 1 positive rail
19	GND	PWR	0 VDC	Power supply ground
20	CSI2-TXD0_N	OUT	According to MIPI CSI-2 D-PHY V1.1	CSI-2 TX data lane 0 negative rail
21	CSI2-TXD0_P	OUT	According to MIPI CSI-2 D-PHY V1.1	CSI-2 TX data lane 0 positive rail
22	GND	PWR	0 VDC	Power supply ground

Table 84: Camera FPC connector pin assignment

# Non-isolated, programmable GPIOs



### Available GPIOs

From four GPIOs, I2C uses two GPIOs for control traffic. Therefore, only two GPIOs are available for user control of the camera.



### I/O cables maximum length

The maximum length for I/O cables must not exceed 30 m.

## GPIOs description

The camera has four non-isolated GPIOs that can be configured by software to act as inputs or outputs.

Alvium GPIOs use the push-pull technology to switch the signal level between low and high. For low levels, the signal is "pulled" down towards ground level. For high levels, the signal is "pushed" up towards VCC level.

Alvium GPIOs feature the CMOS push-pull output drivers and Schmitt trigger inputs with an internal pull-up resistor and a filter circuit, shown in [Figure 76](#). The push-pull GPIOs are able to source or sink current from an external pin.

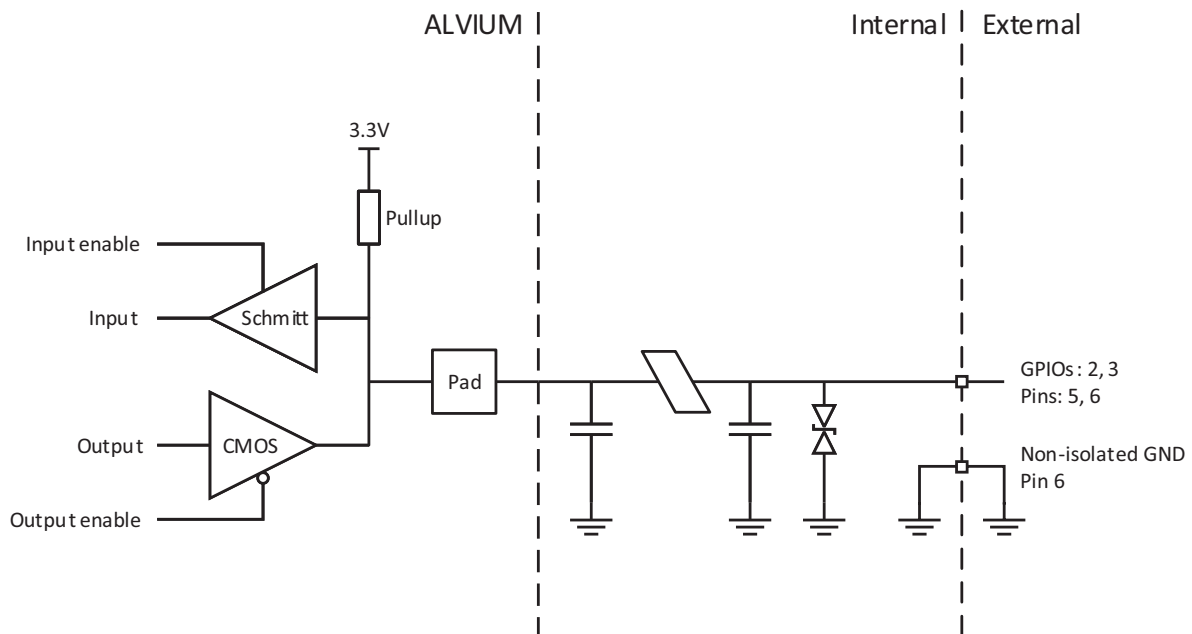

Figure 76: GPIOs block diagram

## Input levels

The GPIOs can be connected directly to the system controlling the camera for voltages up to 5.5 VDC. An external resistor is not necessary.



### NOTICE

#### Damage to the camera by high input voltage

Exceeding maximum input voltage can damage the camera.

Keep maximum input voltage below 5.5 VDC.

Parameter	Value
$U_{in}$ (low)	-0.3 to 0.8 VDC
$U_{in}$ (high)	2.0 to 5.5 VDC
Undefined levels	0.8 to 2.0 VDC

Table 85: GPIOs as input, voltage levels

## Output levels



### NOTICE

#### Damage to the camera by high output current or voltage

The camera can be damaged when connected to a device that exceeds the specified maximum current or voltage. Consider maximum values:

- Max. current = 12 mA per output
- Max. Out VCC = 3.3 VDC

Parameter	Value
External output voltage $U_{out}$ (low)	0 to 0.4 VDC
External output voltage $U_{out}$ (high)	2.4 to 3.3 VDC
Undefined levels	0.4 to 2.4 VDC
Maximum external output voltage	3.3 VDC
Maximum output current	12 mA

Table 86: GPIOs as output, current and voltage levels



#### Output voltage for $U_{Out}$ (high) = On state

The voltage level in the On state depends on the load current. Higher currents yield lower voltage.

## Status LED

Alvium CSI-2 cameras have a green status LED. The following table describes the flashing pattern indicating different events. Inverse flashing: If the LED is already on, it is switched off for a short time.

### Normal operation



LED codes	Behavior	Status
	Continuously active	Power on or idle state
	Irregular flashing	Command or image traffic, such as for camera startup
	Four short flashes and code sequence	Error state

Table 87: LED codes for normal operation

### Error conditions

Four short flashes followed by another sequence indicate errors. In this case, try the following to get the camera back to normal operation:

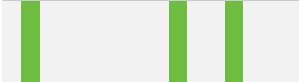
1. Restart the camera.
2. If the LED again indicates error state after restart, please visit [www.alliedvision.com/en/support](http://www.alliedvision.com/en/support).



# Triggering



This chapter includes:

Availability of triggering controls .....	178
Trigger signal flow .....	178
Trigger latency .....	179
Triggering with rolling shutter cameras .....	179

# Availability of triggering controls

Alvium CSI-2 cameras can be triggered by the following boards:

- NVIDIA Jetson AGX Xavier Developer Kit
- NVIDIA Jetson Nano Developer Kit
- NVIDIA Jetson TX2 Developer Kit
- NVIDIA Jetson Xavier NX Developer Kit.



### Downloads

Some boards have restrictions. For more information, go to the examples repository on <https://github.com/alliedvision>.

Use the NVIDIA Jetson driver provided at [https://github.com/alliedvision/linux\\_nvidia\\_jetson](https://github.com/alliedvision/linux_nvidia_jetson)



### Trigger controls description

For more information on triggering controls, see the Direct Register Access Controls Reference at [www.alliedvision.com/en/support/technical-documentation/alvium-csi-2-documentation](http://www.alliedvision.com/en/support/technical-documentation/alvium-csi-2-documentation).

The current firmware supports Frame Start Trigger controls by software or external line signals. Other trigger controls known from GenICam features are not supported.

Some controls may not be supported by all camera models.

# Trigger signal flow

Figure 77 shows an ideal diagram for the trigger signal flow for Alvium CSI-2 cameras. The external signal can be a physical source, such as light barrier as hardware trigger or a software trigger. This external signal starts the exposure of a frame. The end of exposure starts the readout. High levels show the active state of a signal. The different **signals display the workflow**, not user controls.

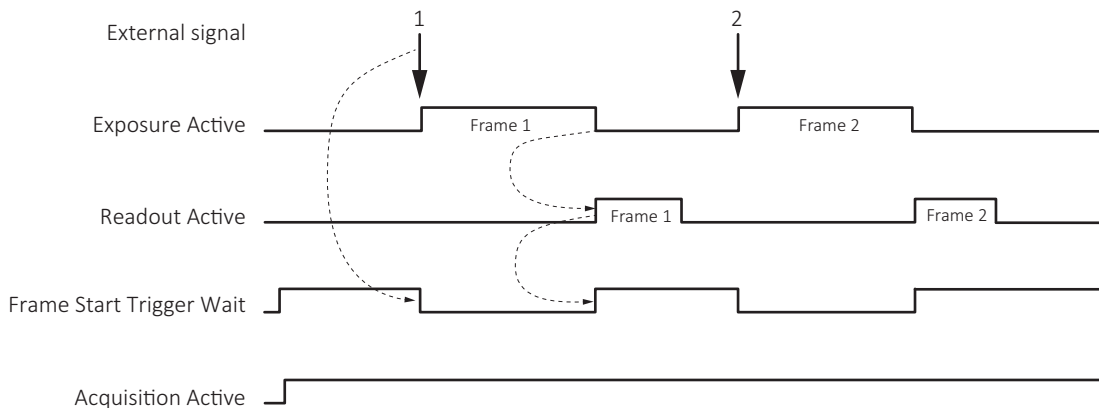

Figure 77: Trigger signal flow

Term	Description
External signal	Electrical trigger signal starting the signal flow
<i>Exposure Active</i>	Exposing a frame
Readout Active	Reading out a frame
<i>Frame Start Trigger Wait</i>	Waiting for a trigger
<i>Acquisition Active</i>	Enables frame acquisition: Expose, read out data, or wait for triggers.

Table 88: Trigger signal flow, legend

## Trigger latency

In theory, a trigger creates an immediate response of the camera, depending on the cable length. In practice, the computer may add a delay that is mostly unpredictable. In addition, camera electronics and sensors have a delay.

Rolling shutter (RS) cameras in this document also have exposure delay, depending on camera settings, see [Triggering with rolling shutter cameras](#) on page 179.

## Triggering with rolling shutter cameras

This section describes triggering behavior for **1500 C-210m/c** and **C-500m/c**, and for **1800 C-1240m/c** and **C-2050m/c**. [Figure 78](#) shows how an external signal triggers exposure and readout for cameras with rolling shutter (RS) sensors. Like for global shutter (GS) sensors, readout has a constant duration, acquisition must be active to enable exposure, the end of exposure starts readout.

Rolling shutter (RS) sensors run in cycles where [readout area](#) equals [exposure area](#). Overlapping triggering is not supported. If exposure time is shorter than readout time, exposure starts with a delay:

**Exposure start delay** = [exposure area](#) – exposure time.



### Signals and controls

The signals displayed in [Figure 78](#) represent logical states, not user controls.

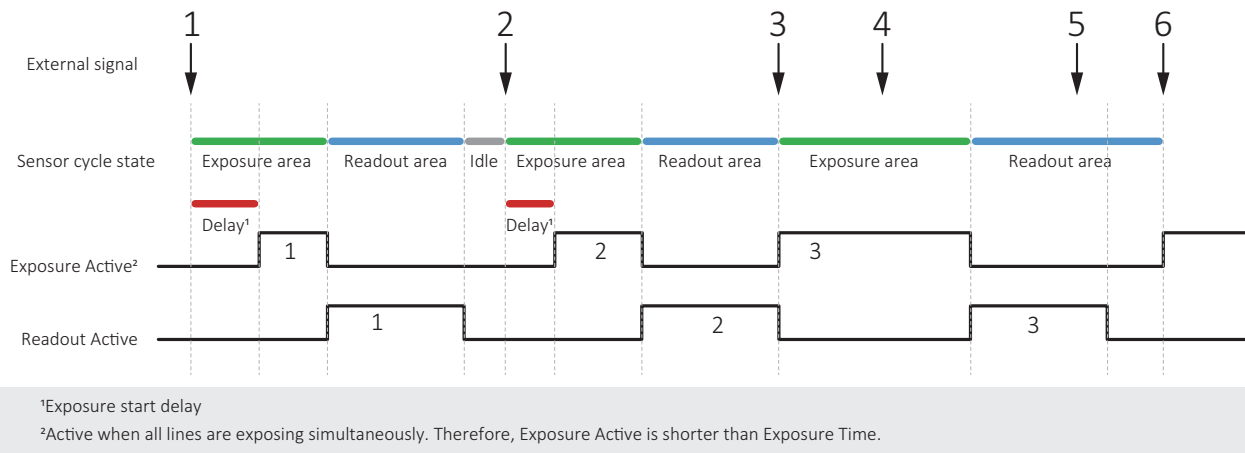

Figure 78: Triggering rolling shutter (RS) cameras

No	Conditions	Results
1	Exposure time is shorter than readout time.	Trigger 1 starts exposure 1 with a delay
2	Exposure time is shorter than readout time, but <b>longer</b> than for exposure 1.	Trigger 2 starts exposure 2 with a delay <b>shorter</b> than for exposure 1.
3	Exposure time is longer than readout time	Trigger 3 starts exposure time without a delay. Because the <b>exposure area</b> is longer, also the <b>readout area</b> is longer than for triggers 1 and 2
4	<b>Exposure area</b> is ongoing.	Trigger 4 is ignored.
5	<b>Readout area</b> is ongoing	Trigger 5 is ignored.
6	<b>Readout area</b> is finished. Exposure time is longer than readout time.	Trigger 6 starts exposure 6 without a delay

Table 89: Triggering conditions and results



#### Frame rates in triggered mode

When rolling shutter cameras are operated in triggered mode, the values for maximum frame rate reached in free run mode are cut in half.

## Trigger delay with 1500 C-120 cameras

If sensor related parameters are changed **directly before** sending an external trigger, the trigger delay can be increased. This relates to [Frame rate jitter](#) on page 184.

# Image data flow

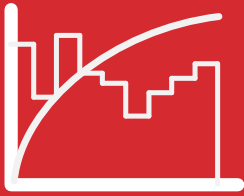

This chapter includes an image data flow of Alvium CSI-2 cameras.

Figure 79 shows image data processing in Alvim CSI-2 cameras in general.

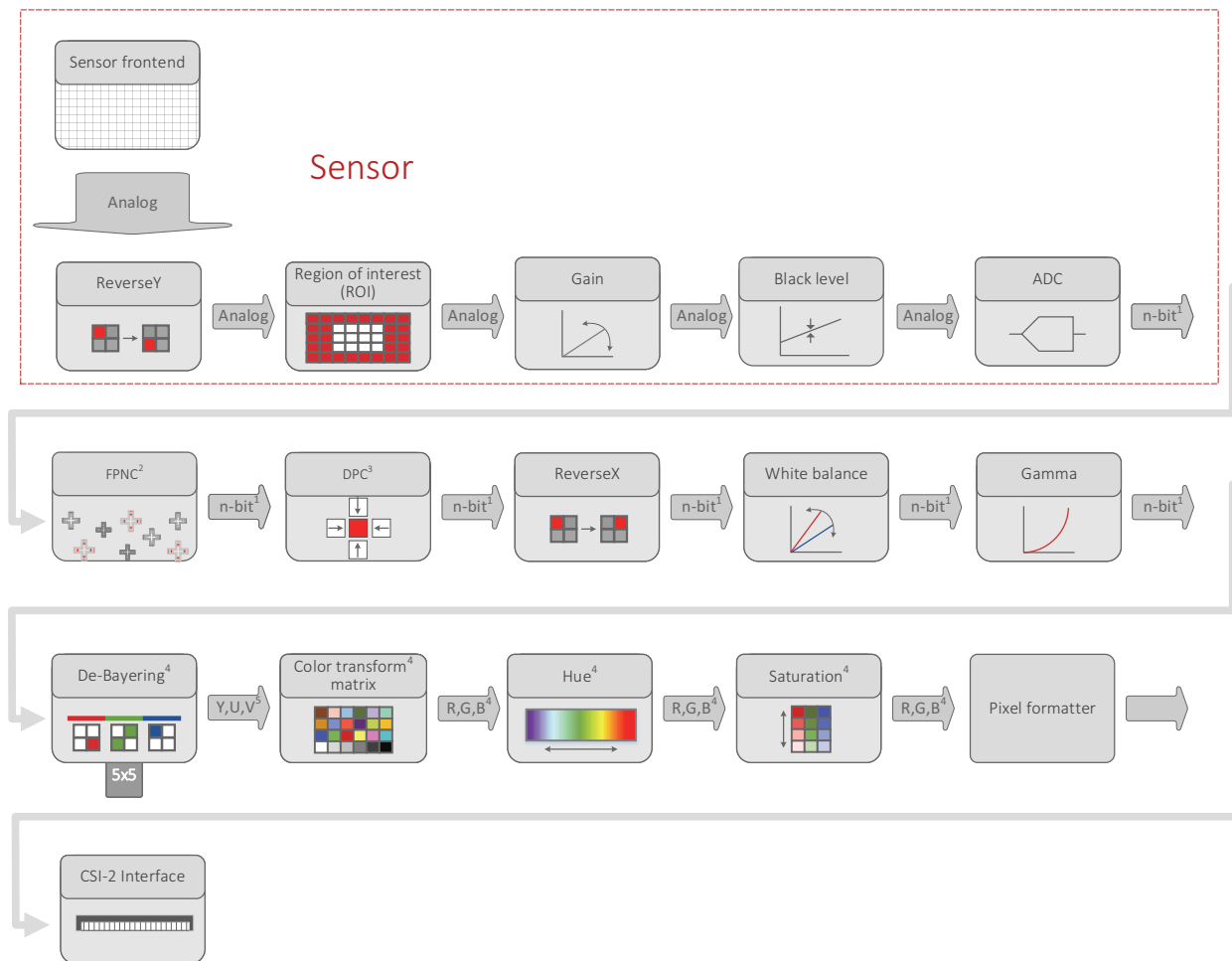

<sup>1</sup> Model dependent: See ADC bit depths in [Specifications](#) on page 43.

<sup>2</sup> Factory preset for FPNC = Fixed pattern noise correction  
The current firmware version does not support FPNC for Alvim 1800 C-2050.

<sup>3</sup> Factory preset for DPC = Defect pixel correction

<sup>4</sup> Color models only

<sup>5</sup> For monochrome models: Y only

Figure 79: Image data flow of Alvim CSI-2 cameras



### Control descriptions

The shown functionalities represent controls or groups of controls:

- For V4L2 controls, see [www.linuxtv.org](http://www.linuxtv.org).
- For register controls, see the Direct Register Access Controls Reference. See [www.alliedvision.com/en/support/technical-documentation/alvim-csi-2-documentation](http://www.alliedvision.com/en/support/technical-documentation/alvim-csi-2-documentation) for details.

# Performance



This chapter includes:

Image transfer with rolling shutter cameras .....	184
Frame rate jitter .....	184
Feature value changes on a streaming camera .....	184
Value changes by control interdependencies.....	185
Dark current compensation .....	187
Shutter types affecting image readout .....	189
Limitations for available resolutions.....	190

# Image transfer with rolling shutter cameras

Affected models: **Alvium 1500 C-210m/c, C-500m/c, 1800 C-1240m/c, and 1800 C-2050m/c**

If acquisition is started and stopped in a short sequence, no image is transferred to the host. The duration cannot be predicted, because it depends on various factors.

## Frame rate jitter

Affected models: **Alvium 1500 C-120m/c, C-210m/c, C-500m/c, 1800 C-1240m/c, and 1800 C-2050m/c**

Generally, some parameters can be changed during exposure without affecting the timing. When the camera is operated in freerun mode, changing parameters during exposure leads to a frame rate jitter.

When parameters are entered, the next frame starts only after readout and sensor reconfiguration delay are finished. When the camera is run in **Exposure Auto** mode, the actual frame rate is less than the calculated value for the corresponding exposure time. Consider frame rate jitter for your application, including a gap between **Exposure Active** signals.

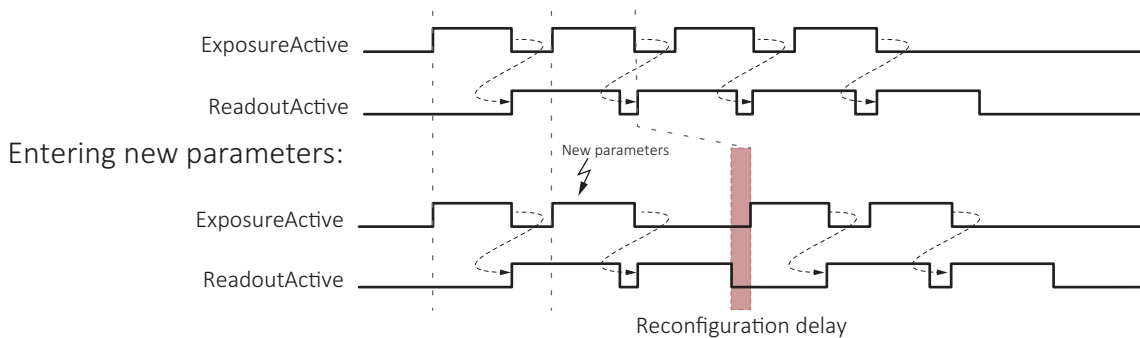

Figure 80: Delayed exposure due to parameter changes

## Feature value changes on a streaming camera

Only some controls can be adjusted while the camera is streaming, these include:

Black Level	Gain	OffsetY
Exposure Auto	Gain Auto	White Balance Auto
Exposure Time	OffsetX	

This list is not complete and will be updated in future document versions.



### Latencies

Consider that value changes become effective with latencies based on the sensor and its operation mode (triggered or free run, frame rate).



# Value changes by control interdependencies

The conversion between time and clock cycles affects control values. Controls for pixel format, bandwidth, cropping (ROI), and exposure time are related to each other. Changing values for one control can change values for another control. For example, frame rates can be reduced when MIPI Data Format is changed subsequently. [Figure 81](#) shows the interdependencies.

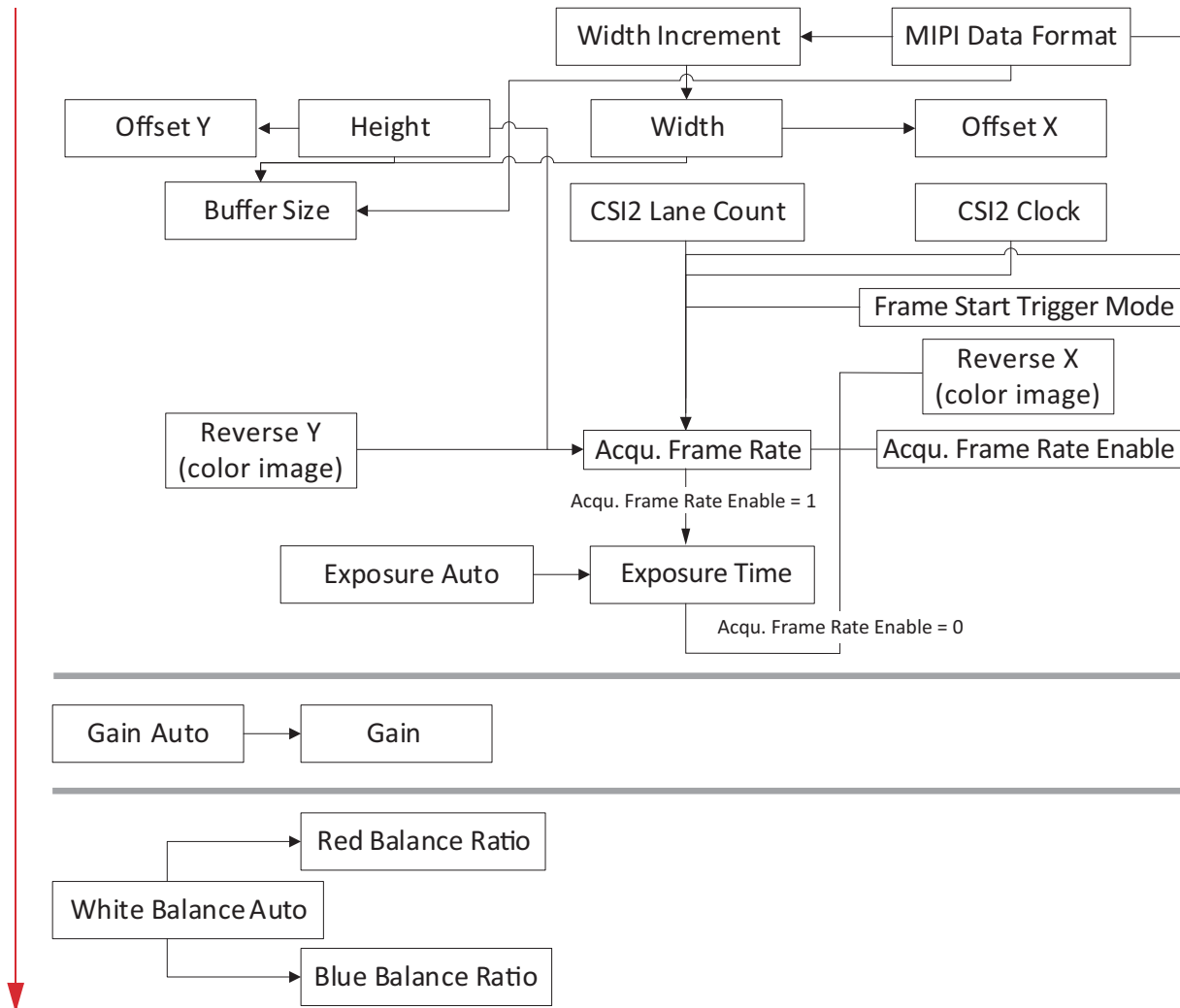

Figure 81: Interdependencies between controls

## Effects for the interdependent controls

Changing one control's value affects other control's values, such as:

If: **Height** value is changed.

Then: Other values may be affected, such as for **Exposure Time**.

We recommend you to consider:

- The more controls you adjust, the more current values deviate from previously set values.
- The same effects that apply to **Exposure Time**, also apply to **Exposure Auto**.
- To avoid readjustments, apply settings in the order shown in [Figure 81](#).

## Impact by other controls

Input	Output	
	Exposure time values	Frame rate
Exposure Time	Affected as expected	Affected
CSI-2 Lane Count	Affected	Affected
Height	Not affected	Affected
Width	May be affected	May be affected

*Table 90: Impact by other controls*

## Exposure times and frame rates with rolling shutter cameras

Affected models: **Alvium 1800 C-1240 m/c and C-2050m/c**

Generally, long exposure times result in low frame rates because one is roughly the inverse of the other. With Alvium IMX RS cameras

- The range of available frame rates depends on the exposure time.
- The exposure time must be increased when low frame rates are used.
- The available range for frame rate values depends on the exposure time. If by changing the exposure time, the previous frame rate is moved out of the available range, the frame rate is adjusted automatically.

# Dark current compensation

All sensors accumulate dark current in the pixels. Dark current increases the signal level and black level. Most sensors in Alvim CSI-2 cameras compensate for this.

For **Alvim 1500 C-050m/c** with the ON Semi PYTHON 480 sensor, see [Black level compensation for 1500 C-050m/c](#) on page 188.

If cameras are operated at high temperatures or exposure times, compensation reaches its limits. The typical compensation mechanism uses a **margin** to compensate for dark current. This works only until dark current reaches the size of the margin. The following table shows the relation of the margin and accumulated dark current for a pixel in 8-bit mode with a maximum value of 255.

Effective signal versus noise	Description
	<p>The pixel has accumulated no dark current, the margin has maximum size.</p>
	<p>The pixel has accumulated some dark current, reducing the size of the margin.</p>
<p>The following images show a pixel that has accumulated a higher dark current than the margin.</p>	
	<p>The pixel has accumulated dark current, the margin reduces to 0.</p> <p><b>Type 1 compensation</b></p> <ul style="list-style-type: none"> <li>• Dark current compensation is stopped.</li> <li>• Dark current increases the black level.</li> <li>• Fixed pattern noise increases.</li> </ul>
	<p>The pixel has accumulated dark current, the margin reduces to 0.</p> <p><b>Type 2 compensation</b> (Typically used for sensor-internal compensation, often in the analog domain.)</p> <ul style="list-style-type: none"> <li>• Dark current compensation stays active.</li> <li>• Maximum saturation signal decreases.</li> <li>• Fixed pattern noise increases.</li> </ul>

Table 91: Accumulated dark current affecting the effective image signal

## Additional compensation

If compensation limits are reached and you cannot decrease operating temperature or exposure time, what can you do to keep signal quality high?

### Measures for type 1 compensation

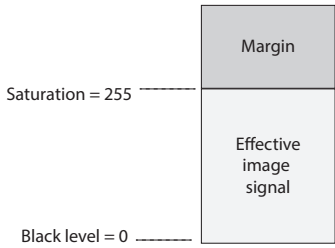
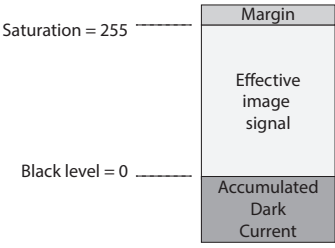
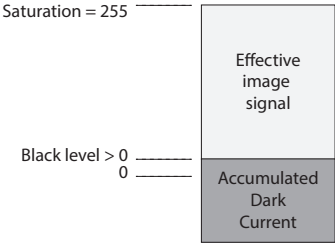
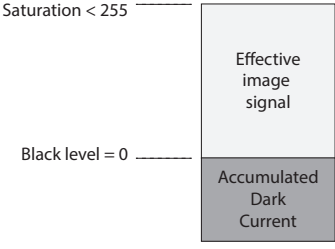
**Alvium 1500 C-050m/c** supports compensation type 1. For additional compensation, see [Black level compensation for 1500 C-050m/c](#) on page 188.

Typically, there is no measure to improve the image signal. The rising black level shifts black and dark gray values to gray.

### Measures for type 2 compensation

All other Alvium camera models support compensation type 2.

You can increase the margin size by using gain, with the following side effects:

- To give space to a larger margin, the effective pixel capacity decreases.
- White and light gray values are shifted down to gray.

## Black level compensation for 1500 C-050m/c

Because the ON Semi PYTHON 480 sensor does not have a dark current compensation, **Alvium 1500 C-050m/c** cameras have a typical black level value drift, depending on exposure time and **Device Temperature** (measured at the mainboard). [Table 92](#) shows the effect of the black level compensation.

Temperature [°C]	ExposureTime [ms]							
	1	10	50	100	250	500	750	1,000
35	Full	Full	Full	Full	Full	Full	Full	Full
40	Full	Full	Full	Full	Full	Full	Full	Full
45	Full	Full	Full	Full	Full	Full	Full	Full
50	Full	Full	Full	Full	Full	Full	Full	Full
55	Full	Full	Full	Full	Full	Full	Full	Full
60	Full	Full	Full	Full	Partial	Partial	Partial	Partial
65	Full	Full	Full	Partial	Partial	Partial	Partial	Partial
70	Full	Full	Partial	Partial	Partial	Partial	Partial	Partial
75	Full	Partial	Partial	Partial	Partial	Partial	Partial	Partial
Full compensation	Full compensation							
Partial compensation	Partial compensation							

Table 92: Exposure time and temperature affecting black level compensation

Should additional compensation be needed, we recommend cooling the camera.

# Shutter types affecting image readout

Some Alvium CSI-2 camera models are operated using global shutter (GS), other models use rolling shutter (RS):

Property	Rolling shutter (RS)	Global shutter (GS)
Line readout		
Line exposure start	Deferred from line to line	Common for all lines
Image acquisition of moving objects		
Moving objects	Distorted shape	Shape without distortion
Typical application	Static objects	Moving objects
Compensation	Use an additional mechanical or use a strobe light in the Strobe area: 	No compensation required.

Table 93: Shutter types affecting image readout

## Limitations for available resolutions

Resolutions stated in this manual refer to camera output. However, the individual setup affects the available minimum and maximum values and increments of your vision system.

The embedded board CSI-2 receiver chip is subject to certain restrictions, limiting the values for:

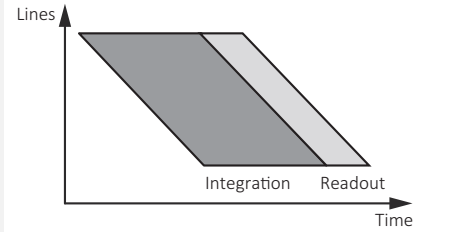
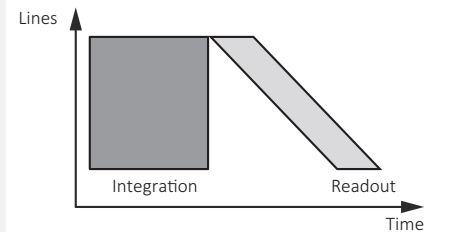
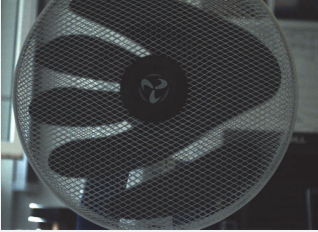
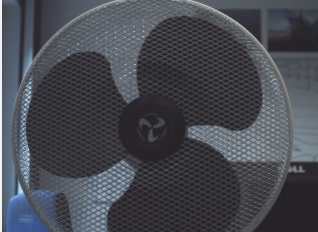
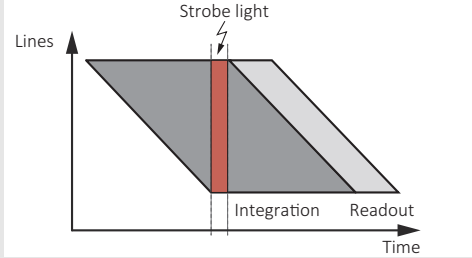
- Packet size minimum
- Packet size maximum
- Packet size increment
- Packets per image.

[Table 94](#) defines limitations for NXP i.MX6 and NVIDIA Tegra boards. For other boards, see the manufacturer's manual.

Specification	NXP i.MX 6	NVIDIA Tegra
Min. packet size [Bytes]	16	32
Max. packet size [Bytes]	8192	32768
Packet size increment [Bytes]	16	1
Min. number of packets	16	32
Max. number of packets	4096	32768
Packet number increment	16	1
Max. frame size [Bytes]	33,554,432	1,073,741,824

*Table 94: Limitations for NXP i.MX 6 and NVIDIA Tegra*

## Dependencies between camera and host

The resulting minimum value is defined as:

$$\text{minimum} = \max(\text{camera\_minimum}, \text{host\_minimum})$$

The resulting maximum value is defined as:

$$\text{maximum} = \min(\text{camera\_maximum}, \text{host\_maximum})$$

The resulting increment value is defined as:

$$\text{increment} = \max(\text{camera\_increment}, \text{host\_increment})$$

## Example

The following example shows how values from [Table 94](#) on page 190 are applied to define available resolutions depending on the camera model and the pixel format. How do host restrictions affect the available maximum resolution?

Specification	Value
Camera model	Alvium 1800 C-2050m/c
Sensor model	Sony IMX183
Camera resolution	19,740,672 pixels
Max. frame size NXP i.MX6	33,554,432 Bytes
Bytes per pixel for RAW8 (GREY)	1
Bytes per pixel for RGB888 (RGB3)	3
RAW8 (GREY) maximum image size [Bytes]	19,740,672--> image transfer is possible
RGB888 (RGB3) maximum image size [Bytes]	59,222,016--> image transfer is not possible

*Table 95: Example values for maximum resolution for a camera-host setup*

# Index

<b>A</b>	
access modes .....	154
Allied Vision contact .....	17
<b>B</b>	
bandwidth .....	48
black level compensation .....	188
<b>C</b>	
compliance .....	33
connectors .....	170
<b>D</b>	
dark current compensation .....	187
Direct Register Access .....	154
document	
conventions .....	28
history .....	25
overview .....	14
<b>E</b>	
ESD .....	37
exposure delay .....	184
<b>F</b>	
FPC connectors, pin assignment .....	172
<b>G</b>	
global shutter (GS) .....	189
GPIOs	
input levels .....	175
output levels .....	175
ground .....	172
ground loops .....	38
<b>H</b>	
hardware assembly	
camera mounting .....	163
FPC cable and FPC connectors .....	160
heat sink mounting .....	162
lens mounting .....	166
heat dissipation .....	35
<b>I</b>	
image data flow .....	182
intended use .....	34
interfaces .....	170
IR cut filter .....	139
<b>L</b>	
lanes .....	172
LED .....	176
lens mounts .....	138
lenses .....	142
maximum protrusion .....	42
mounting .....	166
<b>M</b>	
MIPI CSI-2 .....	44
<b>P</b>	
performance .....	184
pin assignment .....	172
power consumption .....	50
<b>Q</b>	
quantum efficiency .....	46
<b>R</b>	
rolling shutter (RS) .....	189
<b>S</b>	
safety .....	2, 35
bare board cameras .....	40
camera power .....	38
electrical connections .....	37
embedded systems .....	37
FPC cables .....	39
FPC connectors .....	39
ground loops .....	38
heat dissipation .....	35
lens mounts .....	35
maximum protrusion .....	42
optical components .....	41
PCBAs .....	38
sensor .....	41
sensor handling .....	41
sensor position accuracy .....	140
shock and vibration .....	44
S-Mount lenses	
focal length versus FOV .....	144
mounting .....	167
specifications .....	43
support .....	17
<b>T</b>	
triggering .....	177
troubleshooting .....	183
typical operation .....	50
<b>V</b>	
Video4Linux Access .....	154