

LS2E30-150Q8

Light Screen for Machine Safety Applications – Emitter

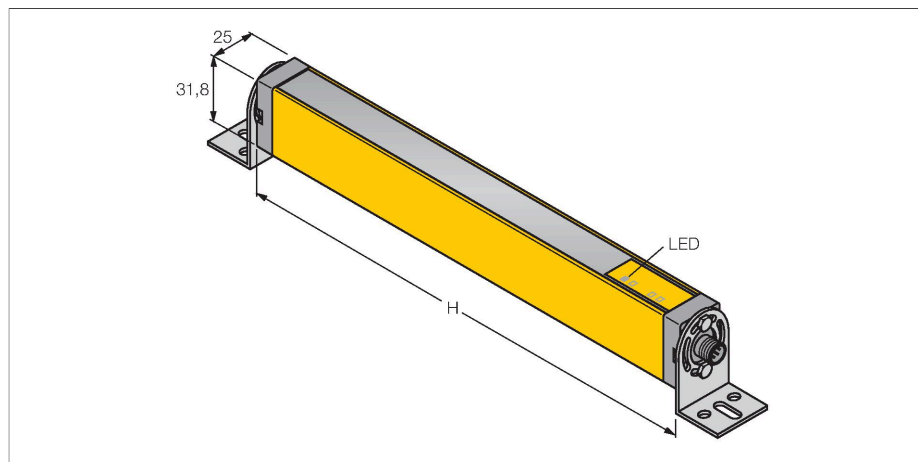

Features

- Male M12 × 1, 8-pin
- Protection class IP65
- Scan field 150 mm
- Resolution 30 mm
- Internal testing in 500 ms cycle
- Range 15 m
- Operating voltage 24 VDC ±15 %
- Type 2 acc. to IEC 61496-1,-2; category 2
PLd acc. to EN ISO 13849-1; SIL2 acc. to IEC 61508

Wiring diagram

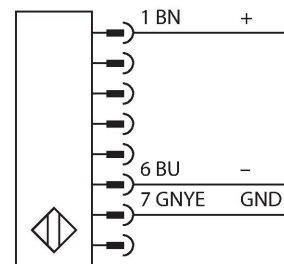

Technical data

Type	LS2E30-150Q8
ID	3073524
Optical data	
Function	Light screen
Light type	IR
Wavelength	950 nm
Optical resolution	30 mm
Range	200...15000 mm
Scan field	150 mm
Number of beams	8
With muting function	no
Scan Code	None
Electrical data	
Operating voltage	20...28 VDC
Residual ripple	< 15 % U _{ss}
DC rated operational current	≤ 50 mA
No-load current	≤ 50 mA
Response time typical	< 11 ms
Blanking function	no
Mechanical data	
Design	Rectangular, EZ-Screen
Dimensions	31.8 x 25.2 x 215 mm
Housing material	Metal, AL, Yellow polyester
Lens	plastic, Acrylic
Cascadable	No
Electrical connection	Connector, M12 × 1
Number of cores	8

Functional principle

The safety light curtain consists of an emitter and a receiver. The system is optically synchronized, making the wiring between emitter and receiver redundant. The receiver's safety switching outputs are directly connected to a load relay and trigger an immediate stop of the dangerous machine cycle. Due to the dual-channel design of the switching device, personal safety degree type 2 acc. to IEC 61496 and category 2 acc. to EN 9541 are fulfilled.

Technical data

Ambient temperature	0...+55 °C
Protection class	IP65
Power-on indication	LED, Green
Tests/approvals	
Vibration resistance	10-55 Hz at 0.35 mm
Shock test	10 g at 16 ms (6000 cycles)
Approvals	CE, cULus listed