

TN-EM30WD-H1147-EX

HF Read/Write Device – For Explosion Hazardous Areas

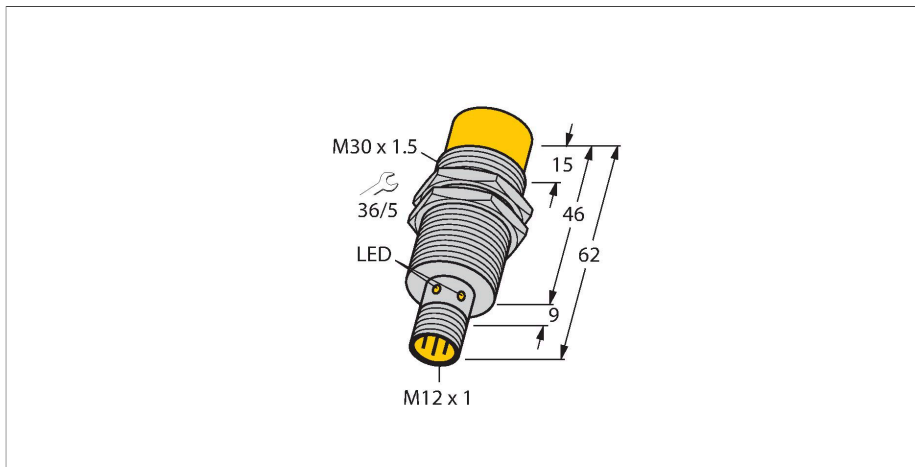

Technical data

Type	TN-EM30WD-H1147-EX
ID	7030386
Remark to product	ATEX
Approvals	CE FCC UL IC FDA ATEX
Device marking	Ⓔ II 3G Ex nA II T4 Gc II 3D Ex t IIIB T135°C Dc
Approval acc. to	TURCK Ex-10005M X
Electrical data	
Operating voltage	10...30 VDC
DC rated operational current	≤ 75 mA
inrush current	700 mA For: 1 ms
Data transfer	Inductive coupling
Technology	HF RFID
Operating frequency	13.56 MHz
Radio communication and protocol standards	ISO 15693 NFC Typ 5
Read/Write distance max.	77 mm
Output function	4-wire, Read/Write
Mechanical data	
Mounting conditions	Non-flush
Ambient temperature	-25...+70 °C
	For explosion hazardous areas see instruction leaflet
Design	Threaded barrel, M30 × 1.5
Dimensions	62 mm
Housing diameter	Ø 30 mm

Features

- M30 × 1.5 threaded tube
- Stainless steel 1.4404
- Front cap made of liquid crystal polymer
- High protection class IP69K for harsh environments
- Special double-lip seal
- Protection against all common acidic and alkaline cleaning agents
- Suitable for applications in the food industry
- Laser-engraved label, permanently legible
- ATEX category II 3 G, Ex zone 2
- ATEX category II 3 D, Ex zone 22

.../S2503 Connectors



.../S2500 Connectors

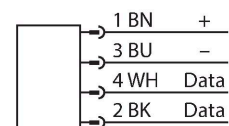

.../S2501 Connectors

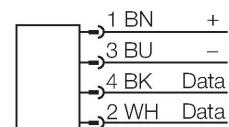

Technical data

Housing material	Stainless steel, 1.4404 (AISI 316L)
Active area material	Plastic, LCP
Vibration resistance	55 Hz (1 mm)
Shock resistance	30 g (11 ms)
Protection class	IP68 IP69K
Electrical connection	M12 × 1
MTTF	391 years acc. to SN 29500 (Ed. 99) 20 °C
Power-on indication	LED, Green
Included in delivery	SC-M12/3GD
Packaging unit	1

Functional principle

The HF read/write devices operating at a frequency of 13.56 MHz form a transmission zone, the size of which (0...500 mm) varies depending on the combination of read/write device and tag used.

The read/write distances mentioned here only represent standard values measured under laboratory conditions, free from any influences caused by surrounding materials.

The read/write distances of the tags for mounting in metal TW-R**-(MF) were determined in metal.

Attainable distances may vary by up to 30 % due to component tolerances, mounting conditions, ambient conditions and material qualities (especially when mounted in metal).

Testing of the application under real operating conditions is therefore essential, especially with on-the-fly reading and writing!

Mounting instructions/Description

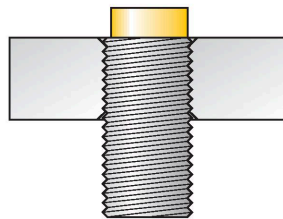

Diameter active area B	Ø 30 mm
------------------------	---------

Width active area B	30 mm
---------------------	-------

non-flush mounting

Dimensions	Type designation	Read-write distance		Transfer zone		Minimum distance between two read-write heads [mm]
		Ident - no.	Recommended (mm)	max. [mm]	length max. [mm]	
	IN TAG 200 SLIX2 100037960	22	40	34	17	90
	IN TAG 200 2K FRAM 100002358	17	31	32	16	90
	IN TAG 300 SLIX2 100002356	22	43	56	28	90
	IN TAG 300 2K FRAM 100002359	23	42	50	25	90
	IN TAG 500 SLIX 100027728	40	72	76	38	90
	IN TAG 500 2K FRAM 100002360	30	58	76	38	90

Accessories

PN-M30

6905308

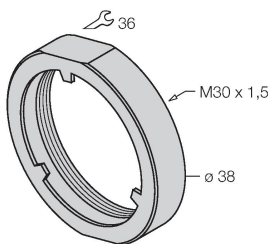

Protective nut for M30 x 1 threaded barrel devices; material: Stainless steel A2 1.4305 (AISI 303)

MW-30

6945005

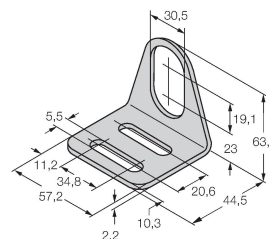

Mounting bracket for threaded barrel sensors; material: Stainless steel A2 1.4301 (AISI 304)

BSS-30

6901319

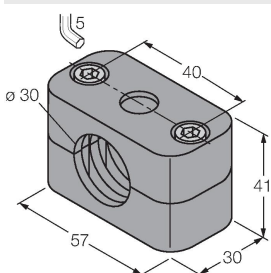

Mounting clamp for smooth and threaded barrel sensors; material: Polypropylene