



## Installation Guide

IG 001 / Rev. 1.9

## eWON 2005CD

This installation guide describes the hardware of the eWON 2005CD and explains how to get started with it.





# Table of Contents

- 1. Product description ..... 4**
  - 1.1. Introduction ..... 4
  - 1.2. General specification of the hardware platform ..... 4
  - 1.3. Functions of the eWON2005CD™ ..... 5
    - 1.3.1. General ..... 5
    - 1.3.2. Virtual Private Network ..... 5
    - 1.3.3. Remote Access Server functions ..... 5
    - 1.3.4. Ethernet to Serial Gateways ..... 5
    - 1.3.5. Programmable Industrial Router functions ..... 5
  - 1.4. Typical applications ..... 6
  - 1.5. Part Numbers and internal options ..... 6
- 2. eWON technical documentation ..... 7**
- 3. Housing & markings ..... 8**
  - 3.1. Housing interfaces ..... 8
  - 3.2. Markings ..... 9
  - 3.3. Safety, Environmental & Regulatory Information ..... 10
    - 3.3.1. Scope ..... 10
    - 3.3.2. Applicable European Directives ..... 10
    - 3.3.3. Applicable Safety Standards ..... 10
      - Battery ..... 10
    - 3.3.4. FCC Compliance ..... 10
    - 3.3.5. Certifications ..... 11
  - 3.4. Equipment information & versions ..... 11
  - 3.5. Mechanical Outline ..... 12
  - 3.6. Mounting & environmental conditions ..... 13
  - 3.7. Preparing the installation ..... 13
  - 3.8. Specification for external Power Supply selection ..... 14
    - 3.8.1. Auto-fuse ..... 14
- 4. Front panel control LED's ..... 15**
- 5. Specifications of communication & I/Os Interfaces ..... 16**
  - 5.1. Ethernet Ports ..... 16
  - 5.2. Embedded PSTN Modem (optional) ..... 16
  - 5.3. Embedded ISDN Modem (optional) ..... 16
  - 5.4. Embedded GPRS-EDGE Quad-band Modem (optional) ..... 17
  - 5.5. Embedded GPRS-EDGE Quad-band Modem (optional) ..... 17
  - 5.6. Embedded UMTS Modem (optional) ..... 18
  - 5.7. Embedded HSUPA Tri-band Modem (optional) ..... 18
  - 5.8. Embedded HSUPA Penta-band Modem EW2620B [Since S/N 1537-0108-xx included](optional) ..... 18
  - 5.9. SIM-Card installation ..... 19
  - 5.10. Configurable serial port ..... 20
  - 5.11. MPI port ..... 21
  - 5.12. Digital input ..... 21
  - 5.13. Digital output ..... 22
- 6. IP parameters configuration ..... 23**
  - 6.1. Resets ..... 24



**Chapter 1**  
Endnotes

- 6.1.1. User Reset ..... 24
- 6.1.2. Factory Reset ..... 24
- Appendix A - Pin-outs & connections ..... 26**
  - A.1 - Power Supply ..... 26
  - A.2 - Ethernet ..... 26
    - A.2.1 - Ethernet LAN ..... 26
    - A.2.2 - Ethernet WAN ..... 27
  - A.3 - Direct connection ..... 28
  - A.4 - Connection over Hub/Switch/Router ..... 29
  - A.5 - RJ-45 Connector ..... 29
  - A.6 - Inputs/Outputs ..... 30
  - A.7 - Serial Port ..... 31
  - A.8 - MPI Port ..... 32
  - A.9 - PSTN/ISDN Phone line connector ..... 33
  - A.10 - Antenna ..... 34
  - A.11 - Antenna for HSUPA EW2620B [Since S/N 1537-0108-xx included] ..... 35
- Revision ..... 36**
  - Revision History ..... 36

## 1. Product description

### 1.1. Introduction

The eWON2005CD™ is the **C**ompact **D**esign evolution of the eWON2005™.

The eWON2005CD™ is the *Industrial LAN/Modem Router* version of a complete range of Ethernet/Internet gateways also known as “Programmable Industrial Routers” (PIR). See our web site <http://www.ewon.biz> to get further information about the eWON range. The eWON is a terminal that enables access to technical data, whatever their format is. It is configurable by web pages. It is secure because it meets the toughest industrial standards and has restricted access features (required in open networks).

The eWON2005CD™ can optionally embed a modem (PSTN, ISDN, GPRS-EDGE or HSUPA).

The eWON range supports the TCP/IP and PPP protocols. This brings you all the benefits of an universally recognized standard network. It also allows you to use popular software tools like Internet Explorer, FTP client, SNMP Manager, Mail Recipient ... and so to reduce significantly your costs (implementation and ownership).

### 1.2. General specification of the hardware platform

- Processor ARM clocked @ 75Mhz, 16Mb SDRAM, 32Mb Flash
- Backed up real time clock (RTC) with 24 Hours autonomy
- Battery with 10 years life expectancy (for RTC)
- External 12-24 VDC +/- 20%, consumption: 10W max
- 1 Ethernet port 10/100Mb BaseTx
- 1 Ethernet switch with 4 ports 10/100Mb BaseTx
- 1 Serial port configurable in RS232/RS422/RS485 OR 1 MPI port (up to 12 Mbits/sec)
- 1 digital input (DI)
- 1 digital output (DO)
- DIN rail mounting compliant with EN50022 (latch)
- Environmental conditions (operating):

Ambient T°: from -20°C to +70°C for eWON with GPRS-EDGE or HSUPA modem

Ambient T°: from 0°C to +50°C for eWON with PSTN or ISDN modem

Humidity: from 0 to 80% non-condensing

## **1.3. Functions of the eWON2005CD™**

### **1.3.1. General**

- Ethernet Gateway to serial protocols
- Web server – fully customizable web pages
- Programmable by BASIC scripts and Java
- Alarm management
- Report generation

### **1.3.2. Virtual Private Network**

Allow to build your own Virtual Private Network (VPN) thanks to OpenVPN technology

### **1.3.3. Remote Access Server functions**

- Remote Access Server (RAS) and TCP/IP Server
- PAP/CHAP Authentication
- Login/password
- Remote network access
- User access control
- Security: NAT, IP filtering
- Conventional and internet callback

### **1.3.4. Ethernet to Serial Gateways**

- MODBUS TCP to MODBUS RTU
- XIP to UNITELWAY
- Ethernet/IP™ to DF1
- FINS TCP to FINS Host link
- ISOTCP to PPI (optionally MPI)
- VCOM / ASCII

### **1.3.5. Programmable Industrial Router functions**

- Automatic routing of protocols
- Programmable routing from I/O and Tag names (BASIC)

## 1.4. Typical applications

- Alarm management
- Sending alarms by network, phone, Email and/or SMS
- Remote measurements, loop back, control and monitoring
- Predictive and operational maintenance
- Diagnosis and machinery status control
- Process and machinery activity logs
- Commissioning support
- Remote programming
- Interface for Application Service Providers (ASP)

## 1.5. Part Numbers and internal options

Part Number structure of the eWON product range:

EWaabzm	
<b>aa = Type of hardware platform</b>	26 = eWON2005CD™
<b>b = Power Supply</b>	2 = Low voltage 12-24DC
<b>z = Serial Port type</b>	0 = RS232 / RS422 / RS485 6 = MPI
<b>m= Modem</b>	1 = No modem (Ethernet only) 3 = ISDN EU modem 4 = PSTN 56k modem 7 = GPRS-EDGE Quad-band A = HSUPA Tri-band modem B = UMTS Global modem [Before S/N 1537-0108-xx *Not included] B = HSUPA Penta-band modem [Since S/N 1537-0108-xx *included]

Type/Description	Part Number
eWON2005CD™/Ethernet only (No modem)	EW26201
eWON2005CD™/ISDN (ISDN modem)	EW26203
eWON2005CD™/PSTN 56 (PSTN 56 modem)	EW26204
eWON2005CD™/GPRS-EDGE (GPRS-EDGE modem)	EW26207
eWON2005CD™/HSUPA (HSUPA Tri-band modem)	EW2620A
eWON2005CD™/UMTS/HSUPA (HSUPA Penta-band modem)	EW2620B
eWON2005CD™-MPI/PSTN 56 (PSTN 56 modem)	EW26264

Examples of Part Numbers for the eWON2005CD™ platform.

## 2. eWON technical documentation

The eWON technical documentation is structured in 4 different levels:

Level	Title	Contents
1	<b>Installation Guide</b> Hardware (present document)	Detailed description of the hardware platform, of its interfaces, available options. Hardware specifications, conformity to standards. Installation recommendations and pin-out of the connectors. <i>Exists for each eWON type</i>
2	<b>Reference Guides</b> Software	Exhaustive reference guides to use all advanced functions of the eWON: <ul style="list-style-type: none"> <li>• General Reference Guide (RG-001)</li> <li>• Programming Guide (RG-002)</li> <li>• Web reference guide (RG-003)</li> </ul>
3	<b>Application User Guides</b>	Guides covering one application topic. For examples: <ul style="list-style-type: none"> <li>• eWON Getting Started</li> <li>• eWON MPI-Teleservice</li> <li>• Unitelway topology Gateway XIP</li> <li>• ...</li> </ul>
4	<b>Knowledge Base</b>	Small document about one technical topic. For examples: <ul style="list-style-type: none"> <li>• How to do a PING function with Basic</li> <li>• eWON serial number structure</li> <li>• eWON modem type</li> <li>• ...</li> </ul>

All those manuals are available for download in PDF format on the eWON website:

<http://support.ewon.biz>.



### 3. Housing & markings

#### 3.1. Housing interfaces

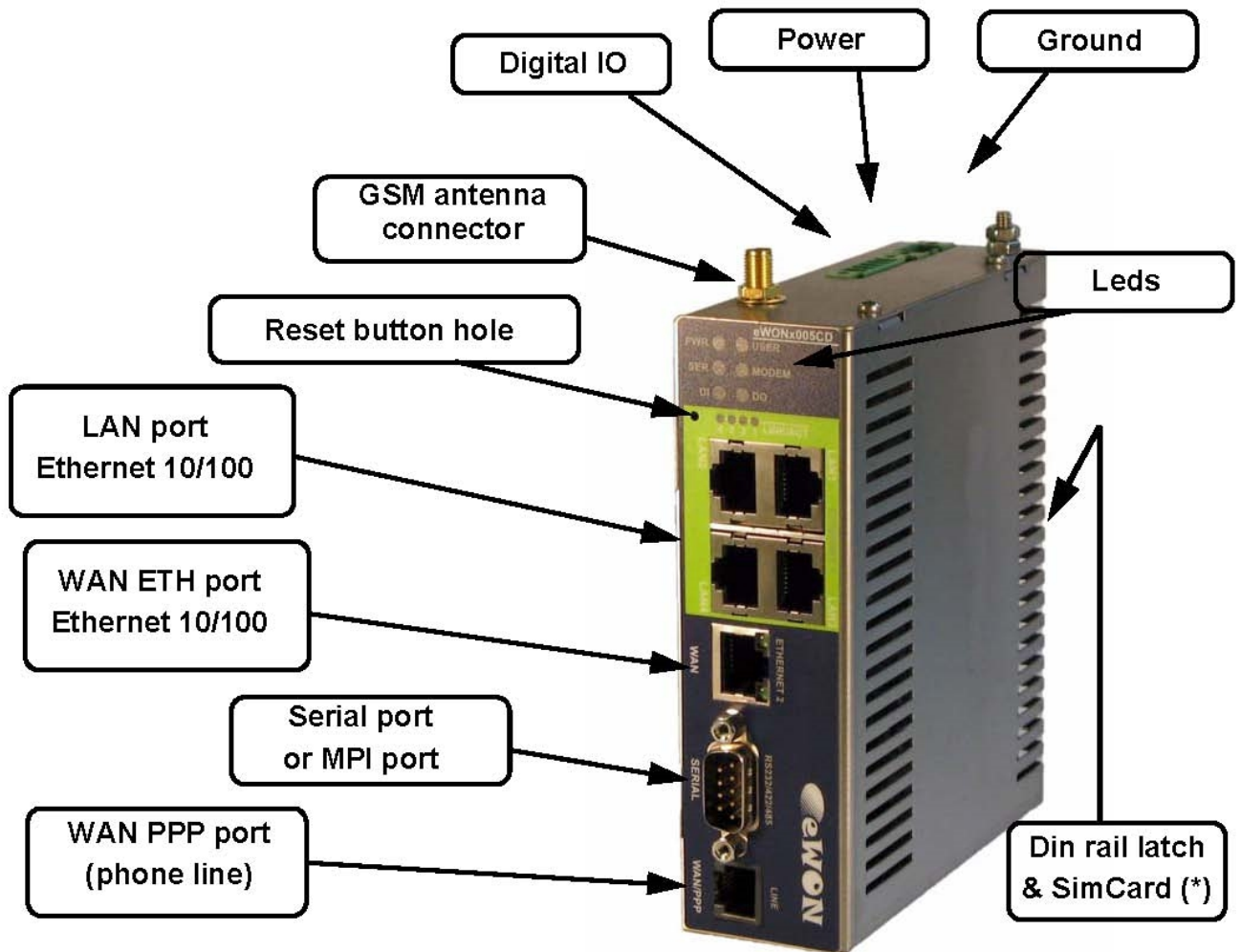

(\*) For HSUPA modem with part number EW2620A only, the SIM card drawer is located on eWON top side.

[See Embedded HSUPA modem](#)



### 3.2. Markings

The identification label of the eWON is placed at the left hand side of the housing. The label is composed of the following fields:

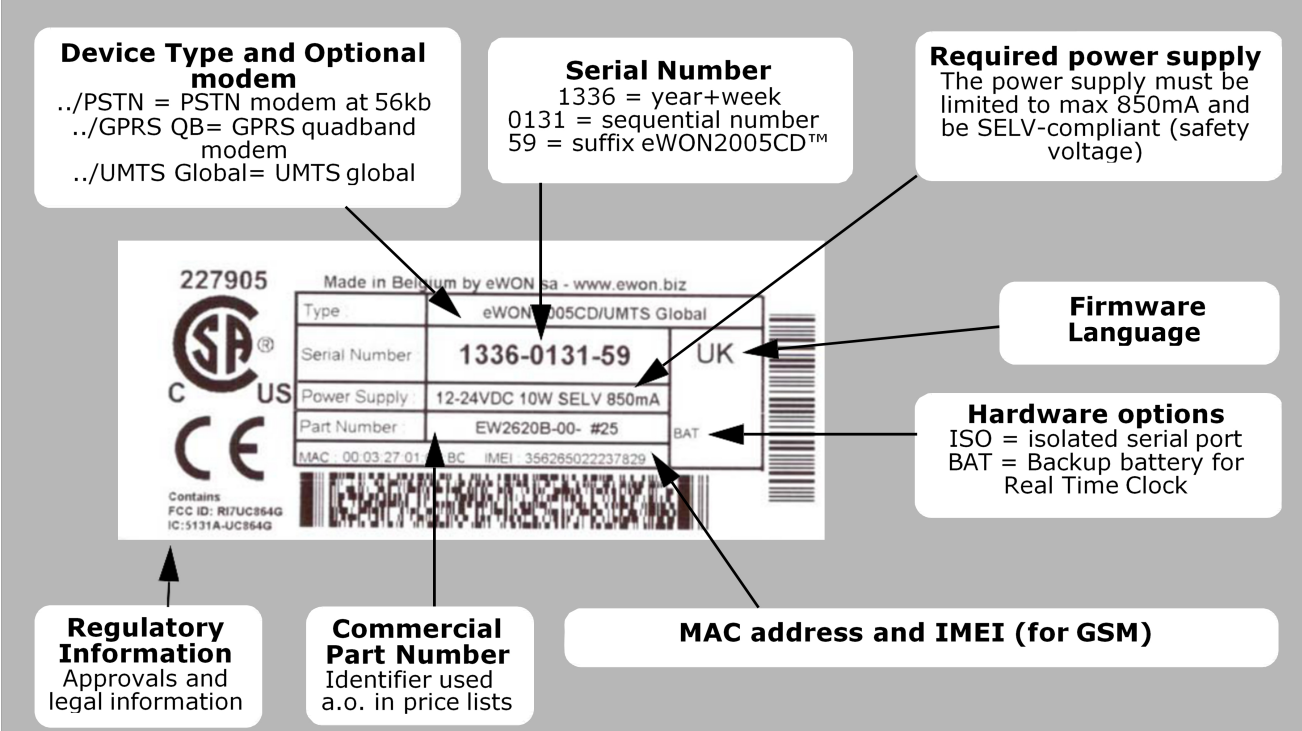

**Device Type and Optional modem**  
 ../PSTN = PSTN modem at 56kb  
 ../GPRS QB= GPRS quadband modem  
 ../UMTS Global= UMTS global

**Serial Number**  
 1336 = year+week  
 0131 = sequential number  
 59 = suffix eWON2005CD™

**Required power supply**  
 The power supply must be limited to max 850mA and be SELV-compliant (safety voltage)

**Firmware Language**  
 UK

**Hardware options**  
 ISO = isolated serial port  
 BAT = Backup battery for Real Time Clock

**Regulatory Information**  
 Approvals and legal information

**Commercial Part Number**  
 Identifier used a.o. in price lists

**MAC address and IMEI (for GSM)**

227905		Made in Belgium by eWON sa - www.ewon.biz	
Type	eWON 2005CD/UMTS Global		
Serial Number	1336-0131-59		
Power Supply	12-24VDC 10W SELV 850mA		
Part Number	EW2620B-00- #25		
MAC	00.03.27.01	BC	IMEI 358285022237829

Contains  
 FCC ID: R17UC864G  
 IC: 5131A-UC864G

The eWON Serial Number (SN) is an important traceability tool both for the user and for the manufacturer. Therefore, next to the product label, each eWON has its serial number stored in the flash memory. This SN is also used in order to scan the network for eWONs and to assign its IP address, subnet mask and gateway.

For more details, [See Equipment information & versions.](#)

### 3.3. Safety, Environmental & Regulatory Information

#### 3.3.1. Scope

The present heading addresses Safety, Environmental & Regulatory Information for the eWON2005CD.

The eWON2005CD range including its optional modems belongs to class A Information Technology Equipment (ITE). In a domestic environment this product may cause radio interference in which case the user may be required to take appropriate measures.

#### 3.3.2. Applicable European Directives

The eWON2005CD range is in conformity with the following directives:

- EMC Directive 2014/30/EU
- RoHS Directive 2002/95/EsC

When applicable\*, the product conform to the corresponding articles:

- RE directive 2014/53/EU

\* Applies to eWONs with embedded wireless modem.

#### 3.3.3. Applicable Safety Standards

The eWON2005CD range including optional modems is in conformity with the following safety standards:

- **IEC/EN 60950-1**
- **UL 60950-1**
- **CSA-C22.2 No 60950-1-07**

#### Battery

**- CAUTION -**

*Risk of explosion if battery is replaced by an incorrect type. Dispose of used battery according to the instructions. Do not disassemble, crush or puncture battery. Do not attempt to open or service battery. Do not dispose of batteries in a fire or with household waste.*

#### 3.3.4. FCC Compliance

The eWON2005CD range including optional modems complies with Part 15 of the FCC Rules. Operating is subject to the following two conditions:

1. This device may not cause harmful interference
2. This device must accept any interference received\*

(\*including interference that may cause undesired operation)

The telecommunication modules used into the eWON routers meets regulatory requirements.

They have been granted modular approval for mobile applications. Integrators may use eWON with telecommunication modules in their host application that can be categorized as mobile devices without additional FCC or R&TTE certification approvals if the following conditions are met (otherwise, additional FCC approvals must be obtained):

- At least 20 cm (7.88") separation distance between the antenna and the user's body must be maintained at all times.
- The eWON and its antenna must not be collocated or operating in conjunction with any other transmitter or antenna.
- To comply with regulations limiting both maximum RF output power and human exposure to RF radiation, the maximum antenna gain, including cable loss, are given in the § 8.8.2 Antenna Specification
- No modifications can be made by the user that can be of influence on the EMC behavior of the device.

### 3.3.5. Certifications

Please check our <http://support.ewon.biz> page to get the current versions of:

- Declaration of Conformity (DoC)
- Other official documents including certificates

### 3.4. Equipment information & versions

The eWON hardware and software revisions can be checked with a web browser on the eWON server.

Once logged onto the eWON, clicking on the eWON logo shows these revisions.

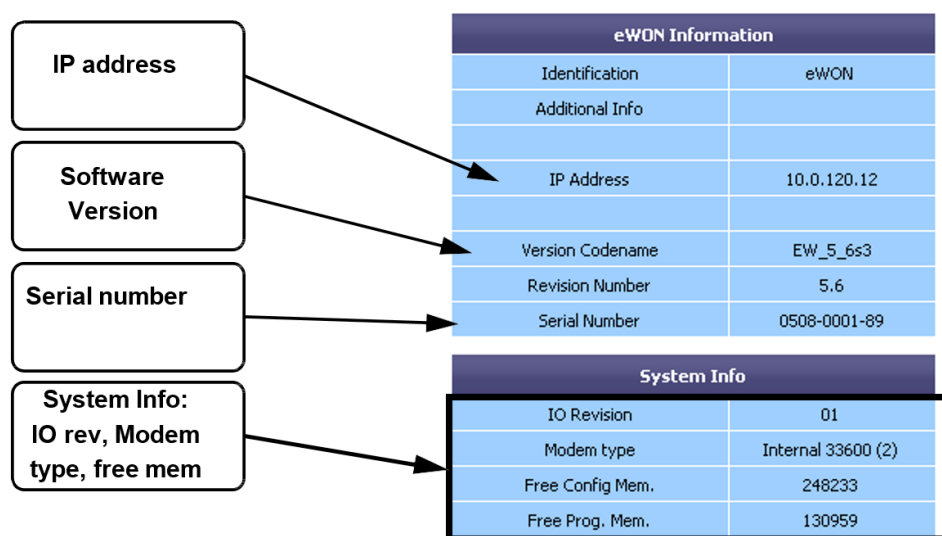

eWON info page details

### 3.5. Mechanical Outline

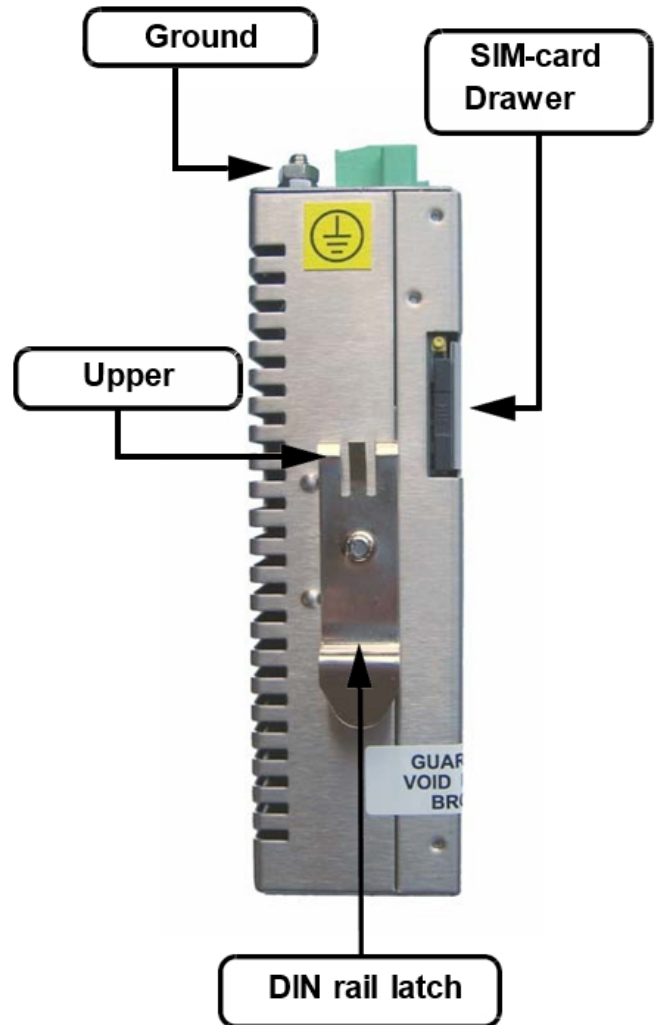
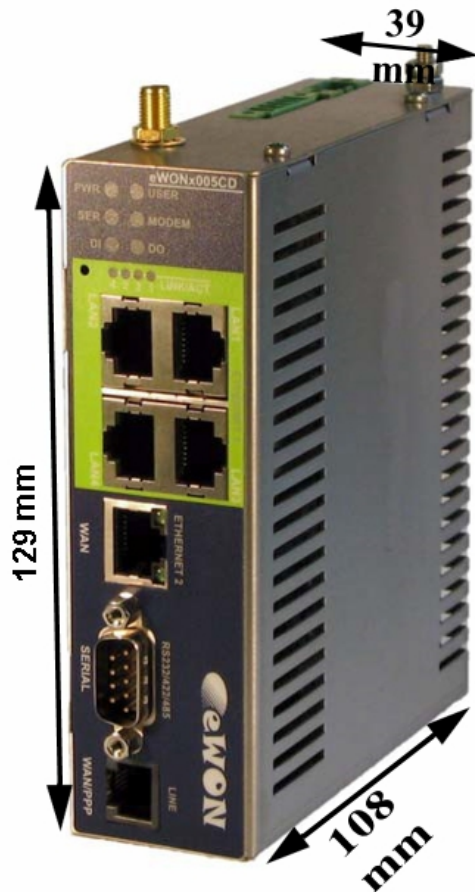

The eWON must be fastened on a 35mm DIN rail compliant with EN50022.

To put the unit in place, insert the upper slider into the upper part of the rail, with the eWON™ tilted around 20°. Then push and rotate the eWON™ downward to put the unit right.

The eWON2005CD™ is now safely fastened.

(\* ) For HSUPA modem with part number EW2620A only,  
the SIM card drawer is located on eWON top side.

[See Embedded HSUPA Modem](#)

### 3.6. Mounting & environmental conditions

The eWON unit has an IP31 protection grade.

It is therefore not suited for outdoor mounting.

The design of the unit is such that it has to be integrated in an enclosed electrical cabinet, protected from excessive heat, humidity and dust. The eWON2005CD™ is complying to the CE-marking requirements regarding electromagnetic compatibility (EMC) within an industrial environment.

The normal mounting position is wall mounted on Omega-type DIN-rail (EN 50022).

The unit is suited to work in any other position.

The equipment will operate within specified tolerances only if the following environmental conditions are respected:

Environment	Conditions
<b>Ambient temperature range</b>	-20°C to +70°C for eWON with GPRS-EDGE-HSUPA modem
	0°C to +50°C for eWON with PSTN or ISDN modem
<b>Ambient humidity</b>	0-80% non-condensing

### 3.7. Preparing the installation

The recommended free space in the cabinet for the eWON should be at least:

**80-mm wide x 200-mm high x 160-mm deep (terminal block excluded).**

A piece of rigid DIN-rail profile (flat 35mm wide) of suitable length should be firmly fastened, horizontally, in the middle of the area.

Grounding the eWON is necessary to eliminate unwanted transients (lightning protection) and to conform to the EMC requirements. Therefore, a ground screw is available at the top of the unit. Connect this screw directly to a low impedance ground.

### 3.8. Specification for external Power Supply selection

The eWON2005CD™ has to be supplied by an external voltage source ranging from 12 to 24 VDC.

The power supplied must be a Class 2 or Level 3, SELV-compliant (Safety Extra Low Voltage) and limited in current to a max of 850mA.

The safety voltage power supply is not part of the delivery.

The data given below is intended to allow correct selection of the external power supply:

Specification	Value
<b>Secondary PS voltage</b>	from 12 to 24 VDC +/-20% (SELV-compliant)
<b>Max secondary PS current</b>	850 mA max.
<b>eWON current protection</b>	2A by auto fuse
<b>eWON voltage protection</b>	30V by transil
<b>eWON EMI filter</b>	Common mode filter <sup>1</sup>
<b>Power absorbed</b>	10 Watts
<b>Input Protection</b>	Protected against polarity inversion

Equipment Supplied by Class 2 or Level 3 Power Supply.

#### 3.8.1. Auto-fuse

An auto fuse placed just after the power input protects the eWON devices against short circuits. This component returns by itself to its normal state when the short circuit has disappeared and after the component has been cooling down.

Would this fuse happen to operate, please check the device for presence of loose metal parts inside likely to generate a short circuit.

If the problem recurs even after such a verification, then return the device to the vendor for further investigation.

---

<sup>1</sup>Properly ground the unit with the earth screw at the top of the unit. This is mandatory to ensure the security and the electromagnetic compatibility (EMC) of the device.

## 4. Front panel control LED's

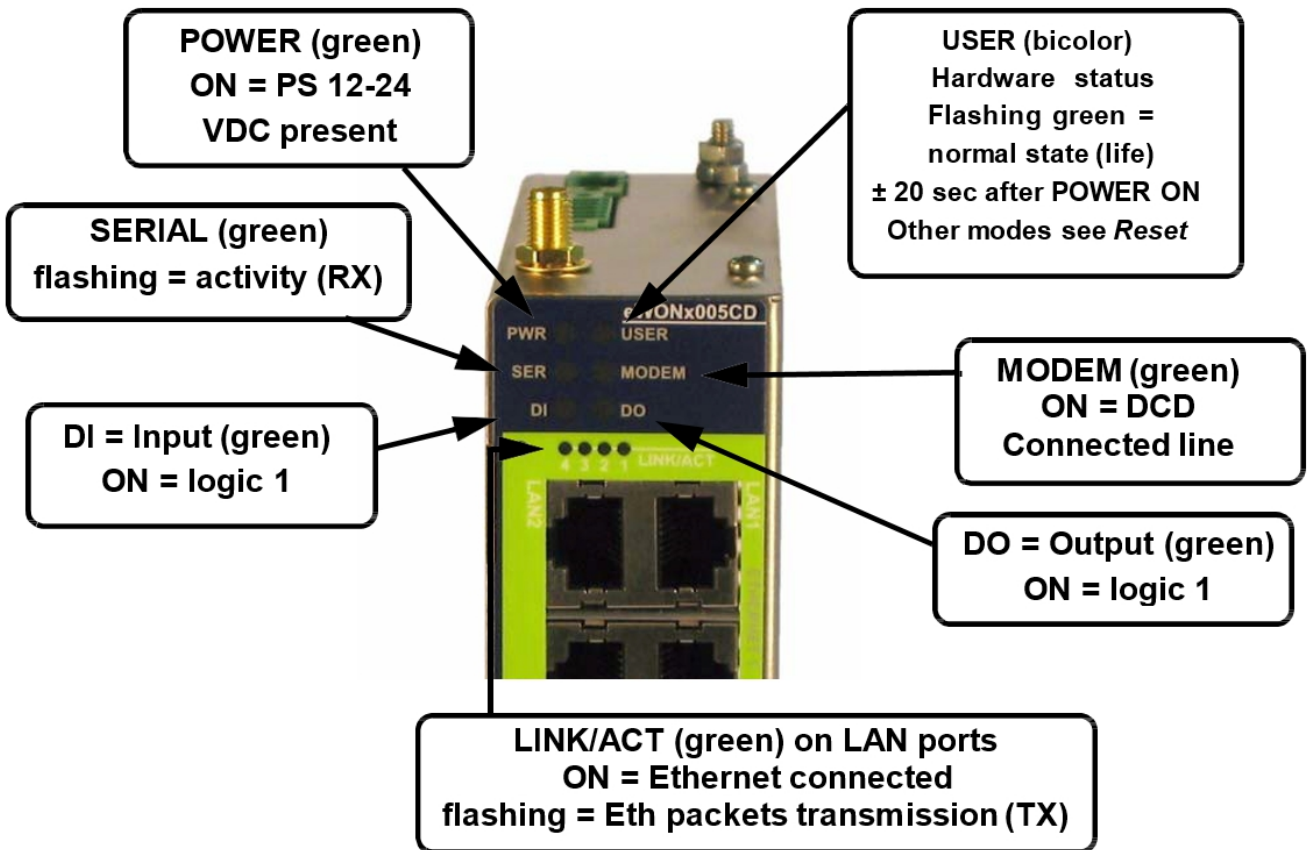

Front panel LED's description



## 5. Specifications of communication & I/Os Interfaces

### 5.1. Ethernet Ports

The eWON2005CD™ has 2 Ethernet interfaces:

- a LAN (Local Area Network) with an integrated 4 ports switch
- a WAN (Wide Area Network) with one port

Specification	Value
Applicable standard	10/100BaseTX
Isolation	1,5 kV
Pin-out RJ45 connector	<a href="#">See RJ45 connector</a>

Please refer to the appendix ([Direct connection](#) and [Connection over Hub/Switch/Router](#)) for information on the different Ethernet connection modes (straight and crossed cables).

### 5.2. Embedded PSTN Modem (optional)

Specification	PSTN 56k
Max baud rate	(V92) 56.000 bps
Pin-out phone line connector	<a href="#">See PSTN/ISDN Phone Line</a>
Leased Line mode	No

### 5.3. Embedded ISDN Modem (optional)

Specification	PSTN 56k
ISDN specification	ISDN BRI S0.I.430
Type	1B+D
Max baud rate	64 Kb
Certification	---

### 5.4. Embedded GPRS-EDGE Quad-band Modem (optional)

Specification	GPRS-EDGE
<b>Bands</b>	Quad band EDGE 850/900/1800/1900 MHz
<b>E-GPRS Class</b>	Class 10
<b>Max baud rate</b>	115 kbps (theoretical)
<b>Compliant to standards</b>	R&TTE, CE, FCC
<b>Certificate number</b>	- - -
<b>Antenna connector<sup>2</sup></b>	Type SMA-F

### 5.5. Embedded GPRS-EDGE Quad-band Modem (optional)

Specification	GPRS QB
<b>Bands</b>	Quad band EGSM 850/900/1800/1900 MHz
<b>Class</b>	GPRS Class 10
<b>Max baud rate</b>	40 kbps (theoretical)
<b>Compliant to standards</b>	R&TTE, CE, FCC
<b>Certificate number</b>	- - -
<b>Antenna connector<sup>3</sup></b>	Type SMA-F

<sup>2</sup> Tightening torque for SMA antenna connector: MAX 0.5N.m (manual tightening should be used as a reference) [See Antenna](#).

<sup>3</sup> Tightening torque for SMA antenna connector: MAX 0.5N.m (manual tightening should be used as a reference) [See Antenna](#).

### 5.6. Embedded UMTS Modem (optional)

Specification	UMTS Global
<b>Bands</b>	Quad band EGSM (850/900/1800/1900 MHz) Tri band UMTS/HSDPA (850/1900/2100 MHz)
<b>Class</b>	GPRS Multi-slot Class 12 EDGE Multi-slot class 12
<b>Max baud rate</b>	230 kbps (theoretical)
<b>Compliant to standards</b>	R&TTE, CE, FCC
<b>Certificate number</b>	---
<b>Antenna connector (*)</b>	Type SMA-F

(\*) Tightening torque for SMA antenna connector: MAX 0.5N.m (manual tightening should be used as a reference) [See Antenna](#).

### 5.7. Embedded HSUPA Tri-band Modem (optional)

Specification	HSUPA
<b>Bands</b>	Quad band EGSM (850/900/1800/1900 MHz) Tri band UMTS/HSUPA (850/1900/2100 MHz)
<b>Class</b>	GPRS Multi-slot Class 12 EDGE Multi-slot class 12
<b>Max baud rate</b>	921 kbps (theoretical)
<b>Compliant to standards</b>	R&TTE, CE, FCC
<b>Certificate number</b>	---
<b>Antenna connector (*)</b>	Type SMA-F

(\*) Tightening torque for SMA antenna connector: MAX 0.5N.m (manual tightening should be used as a reference) [See Antenna](#).

### 5.8. Embedded HSUPA Penta-band Modem EW2620B [Since S/N 1537-0108-xx included] (optional)

Specification	HSUPA
<b>Bands</b>	Quad band EGSM (850/900/1800/1900 MHz) Penta band HSUPA (850/900/1700/1900/2100 MHz)
<b>Class</b>	GPRS Multi-slot Class 33 EDGE Multi-slot class 33
<b>Max baud rate</b>	921 kbps (theoretical)
<b>Compliant to standards</b>	R&TTE, CE, FCC
<b>Certificate number</b>	---
<b>Antenna connector (*)</b>	Type SMA-F

(\*) Tightening torque for SMA antenna connector: MAX 0.5N.m (manual tightening should be used as a reference) [See Antenna](#).

### 5.9. SIM-Card installation

Sim card installation is common to:

- GPRS-EDGE Modem
- GPRS quad band Modem
- UMTS Modem
- UMTS/HSUPA Modem with part number EW2620B

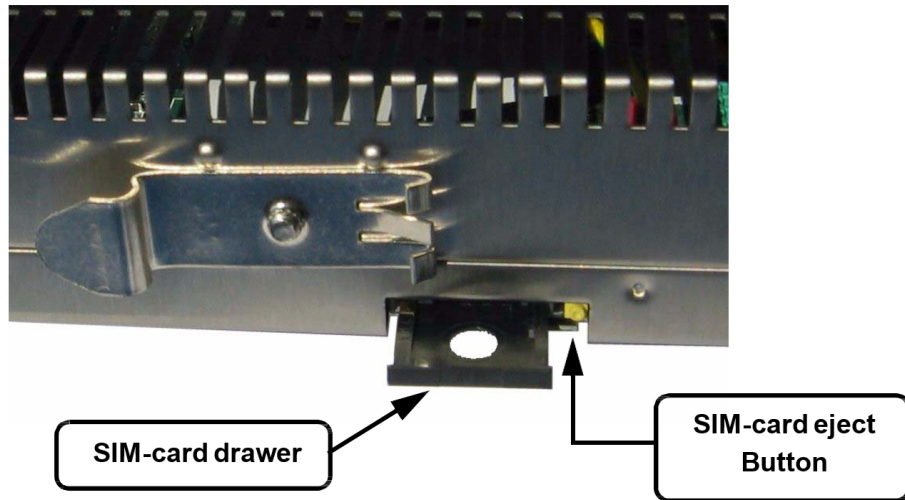

For HSUPA modem with part number EW26206B **only**, the SIM-card drawer is located on the top of the eWON.





### 5.10. Configurable serial port

Specification	Value
Physical modes (configurable)	RS232/RS485/RS422
Isolation	Not isolated
Pin-out connector	<a href="#">See Serial Port</a>

The configuration of the physical serial mode is done by a set of 4 dip switches located on left side of the unit.

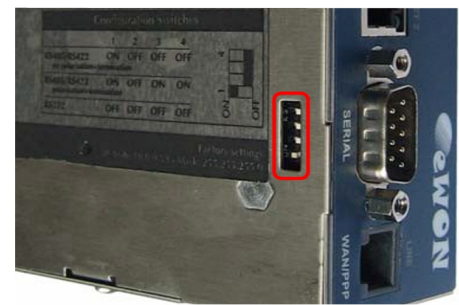
The settings of the switches are shown in the table below (note: switch 1 is the right one)

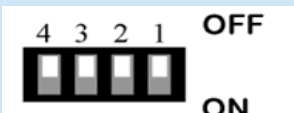
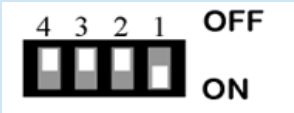

Position	Mode
	RS232
	RS422, RS485 <b>WITHOUT</b> polarization and termination resistor
	RS422, RS485 <b>WITH</b> polarization and termination resistor

**- Note -**

*The 3 switch configurations shown here above are the sole configurations giving satisfactory results. That switch 3 & 4 need to have the same position (both ON or both OFF). When they are ON, it connects the internal polarization (typ 680 Ohms) and termination (typ 120 Ohms) resistors. This configuration applies only to RS485/RS422 lines conforming to good practices.*

**- WARNING -**

*The switch 2 is reserved and must stay OFF.*

### 5.11. MPI port

The MPI port is easily identifiable with its light blue square (surrounding a female DB9 connector)

Specification	Value
Physical mode	MPI
Speed	9.6/19.2/45.45/93.75/187.5 kBauds 1.5/3.0/6.0/12.0 MBauds
Polarization	100kOhms
Termination	-
Pin-out connector	See MPI port

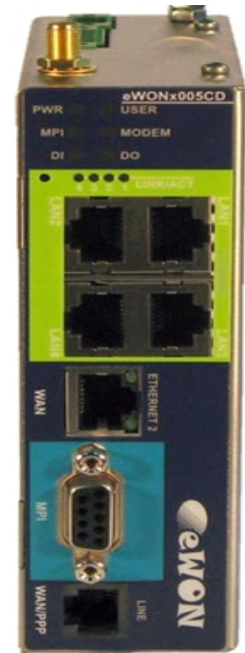

### 5.12. Digital input

Specification	Value
Input voltage range	0 to 24 VDC
Input voltage absolute max (varistor protection)	33 VDC
Zero state max input voltage (OFF)	5 VDC
One state voltage range (ON)	10 to 30 VDC
One state currents (ON)	3.8mA @ 12VDC 8.2mA @ 24VDC
Isolation	3,5 kV
Pin-out connector	See Input/Outputs

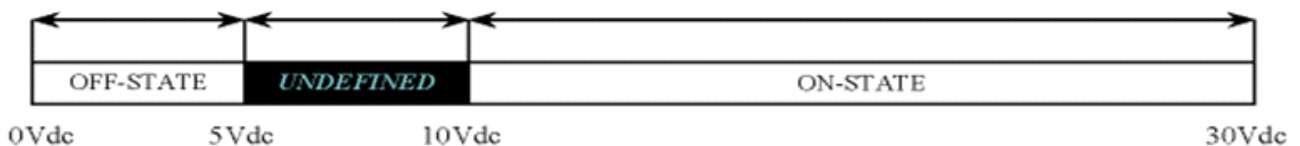

The input range extends from 0 to 24VDC (30VDC max). A zero logic (OFF) state is detected when the input level is below 5Vdc. A one logic (ON) state is detected when the input level is above 10Vdc.

**- WARNING -**

*The logic level is undefined when the input is ranging between 5 and 10VDC.*

### 5.13. Digital output

Specification	Value
Type of output	Open drain (MOSFET)
Max current (external source)	200mA @ 30 VDC
Isolation	3,5 kV
Pin-out connector	<a href="#">See Input/Outputs</a>

This digital output is activated by an open drain MOSFET transistor driven by an optocoupler. The maximum current flow into this transistor has a characteristic above the value specified in the eWON, in order to cope with the switching power losses. The transistor used is in an open drain type with pre drive. This means the relay power supply has to be supplied from an external source to the pre drive electronics.

The diagram below shows the external wiring needed for correct operation of the digital output. A relay has been chosen for this sample application but any load within the specifications can be used instead.

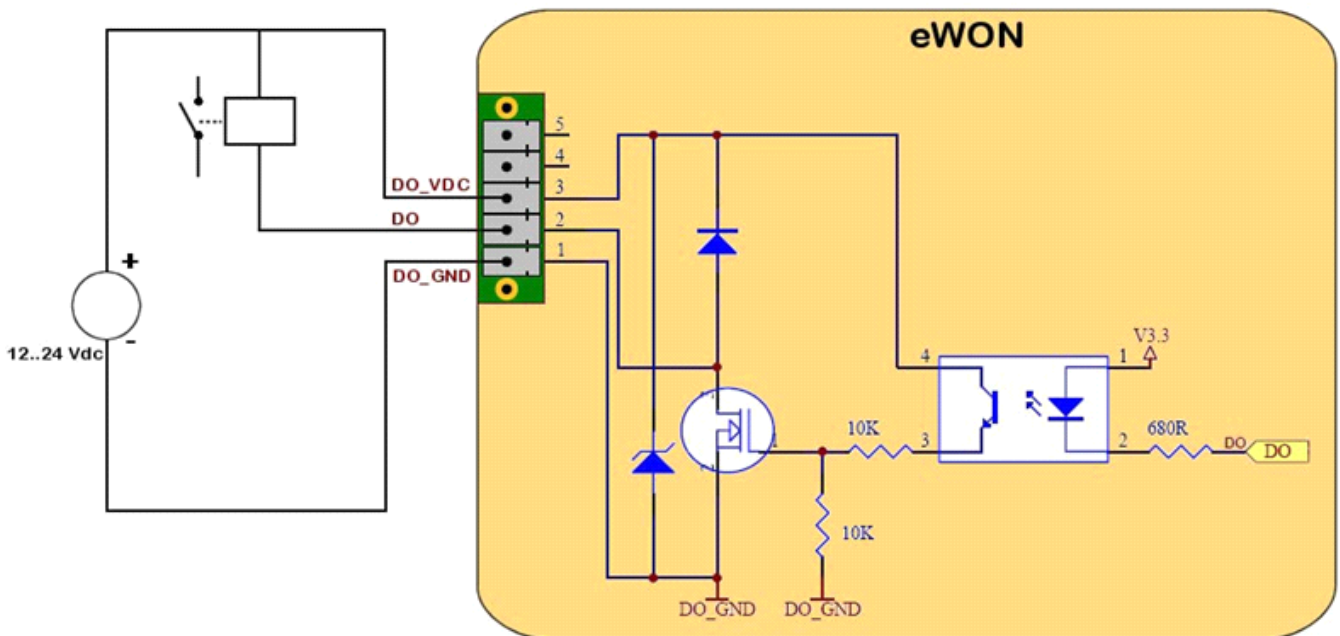

**- WARNING -**

*Note that this is a sink only output to ground (the transistor acts like a switch to ground).*



## 6. IP parameters configuration

**- WARNING -**

Normally you cannot communicate with a device of which you don't know the IP parameters. Therefore, there is a special tool (called "eBuddy") you can download from the eWON Internet site <http://www.ewon.biz>.

Start this application once you have connected your eWON to the network. The application will scan the whole network and will identify all eWONs that are connected, including their IP parameters (Address and subnet mask) and their serial number. The utility allows also to edit the IP parameters. IP parameters always have to be defined in full agreement with network policies applicable within your organization (ask your network administrator).

Default IP settings:

LAN Interface factory configuration	
IP address	10.0.0.53
Subnet mask	255.255.255.0

WAN Interface factory configuration	
IP address	10.1.0.53
Subnet mask	255.255.255.0
Gateway	0.0.0.0

**- WARNING -**

By default, the WAN interface is disabled. Then, first connection must be done by the LAN.

Modem Interface (incoming PPP) factory configuration	
IP address	202.0.0.240
Subnet mask	255.255.255.0

**- Note -**

By default, the incoming PPP connection is allowed.

## 6.1. Resets

### - WARNING -

*You should not reset your eWON unless you have been told to do so by someone of our technical support. The concerned files (differs depending on reset type) are totally lost and unrecoverable after being formatted.*

To press the reset button:  
you will need a propelling pencil  
(or an unfold paper clip)  
to pass through the hole in the front panel.

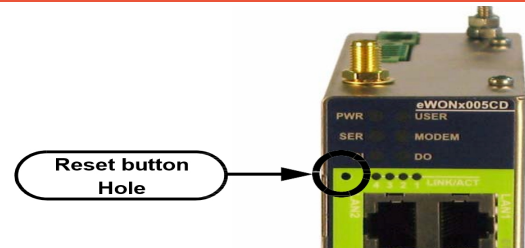

### 6.1.1. User Reset

This is the first level and most usual level of reset. It consists in formatting only the « user file » part of the non-volatile memory. The Tag configuration and the customer web site are part of the formatted files.

You generate this first level reset by pressing and maintaining the reset button during approximately 4 seconds after powering the eWON up until the “USER” LED flashes in red 1x per second.

When this state is reached, release the button and wait approximately 30 secs until the procedure is completed. The eWON restarts automatically and is ready to communicate. This type of reset does not modify the communication parameters.

### 6.1.2. Factory Reset

This second level reset is used only exceptionally because it formats all non volatile memories and make the eWON returning to its factory defaults. This operation consists in 3 stages:

- Formatting of all non volatile memories, including all COM parameters and IP addresses
- Return to ex-factory configuration (default configuration)
- Full hardware auto test with result shown by the “USER” LED

You generate this second level reset by pressing and maintaining the reset button during approximately 20 secs after powering up the eWON until the “USER” LED remains RED continuously. When this state is reached, release the button and wait approximately during 90 seconds until the procedure is completed.

The procedure finishes with the result of the auto test on the “USER” LED. If the auto test is completed successfully, then the “USER” LED will blink in RED with a pattern of 200ms ON and 1,5 sec OFF.

Any other pattern will start with 200ms ON (opening of the pattern) followed by OFF and a certain number of times 1 sec ON that allows to identify the nature of the detected problem. Please call the technical support if you are confronted with an error pattern on the “USER” LED.

**- WARNING -**

*You absolutely have to wait until the full auto test procedure is completed without interrupting it. If the auto test is interrupted, the flash memory of the eWON will contain random data likely to make it unstable. In such a case you have to redo the full reset procedure from scratch and wait until it is totally completed.*

When performing a full reset, the eWON does NOT restart in normal mode by itself and remains running in diagnose mode. Power the eWON OFF and ON again to restart in normal mode. As described before, the eWON returns to its default COM parameters and IP addresses after this level 2 reset is performed.

## Appendix A - Pin-outs & connections

### A.1 - Power Supply

Manufacturer :

Phoenix Contact GmbH,

<http://www.phoenixcontact.com>

Part Number: GMSTB 2,5/2-STF-5.08

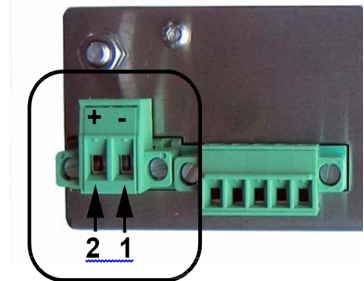

PIN	Description
1	Ground
2	Positive (+)

### A.2 - Ethernet

By default, only the LAN Ethernet interface of the eWON2005CDTM can be used to access the internal Web Site

#### A.2.1 - Ethernet LAN

The Ethernet LAN is a four ports auto-sense Ethernet switch (10/100 Mb). Auto-sense means that you can use both direct and crossed cables.

Color & Activity	Description
OFF	No LINK
GREEN Fixed	LINK
GREEN Blinking	Activity (RX or TX)



### A.2.2 - Ethernet WAN

The eWON can be accessed by a 10/100BaseTX Ethernet connection. This connection can be made with two different cables (straight or crossed). These cables have 8 copper conductors and are known as UTP Class 5 with RJ45 terminations at both ends.

The type of cable (straight or crossed) depends on the equipment the eWON will be connected to. The most current cases are the direct connection with a PC (crossed) and the connection through a hub/router (straight).

The WAN port have 2 LEDs showing the state and activity on the port.

Position	Color & Activity	Description
Upper LED	OFF	No LINK
	GREEN Fixed	LINK
Lower LED	GREEN Blinking	Activity (RX or TX)



**- WARNING -**

*By default, the WAN interface is disabled.*

### A.3 - Direct connection

If the eWON is connected directly to a PC, then use the crossover cable:

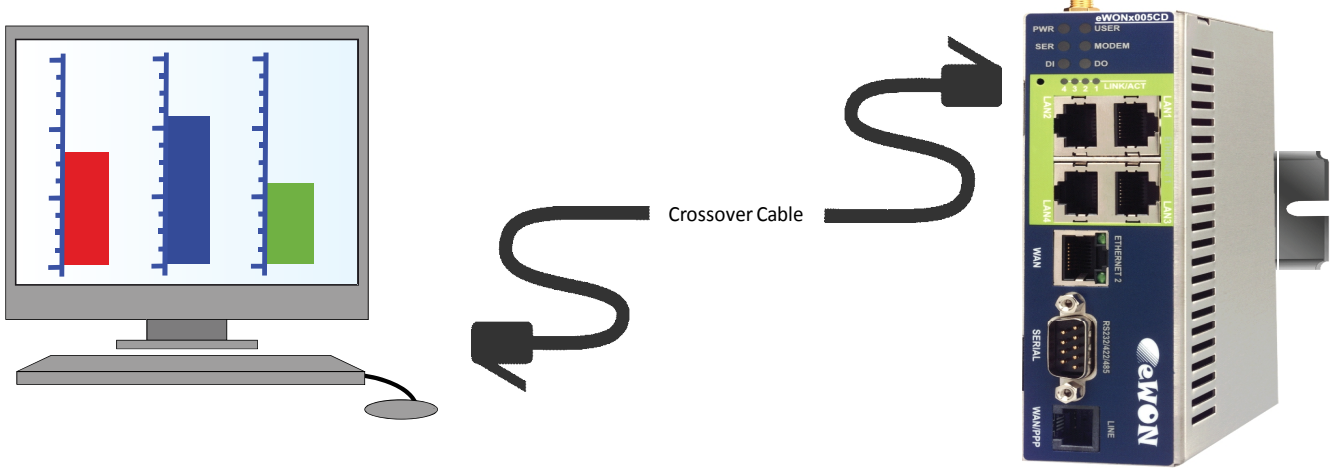

As the LAN interface is “auto sense”, you can use a crossover or straight Ethernet cable, but generally, a direct connection is done with a crossed cable.

The WAN interface is not “auto sense”, then you must use a crossover Ethernet cable to make a direct WAN connection.

When cabling over long distance, you have to take care of the twisted pairs.

This means that along with the above cabling conventions, the emission (TX+/TX-) and reception (RX+/RX-) signals have to be connected on the same twisted pair:

Pin Position	Description
<b>TX+: pin3, TX-: pin6</b>	Twisted pair 1
<b>RX+: pin1, RX-: pin2</b>	Twisted pair 2

Pins 4, 5, 7 and 8 do not have to be connected.  
The following picture shows the twisted pair connections:

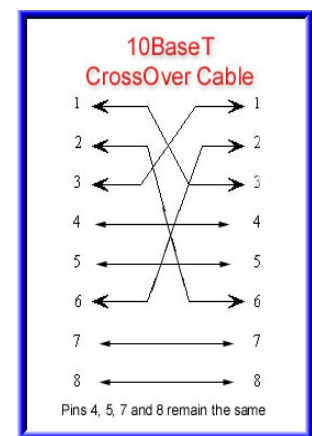
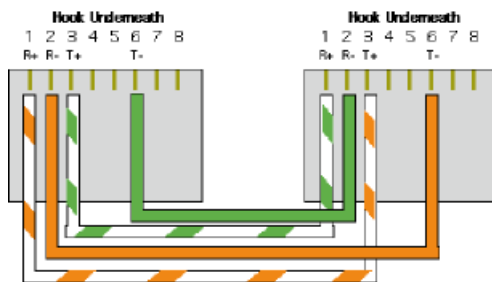

### A.4 - Connection over Hub/Switch/Router

If the eWON is connected to a Hub/Switch, it has to be connected like any other device, with a straight cable.

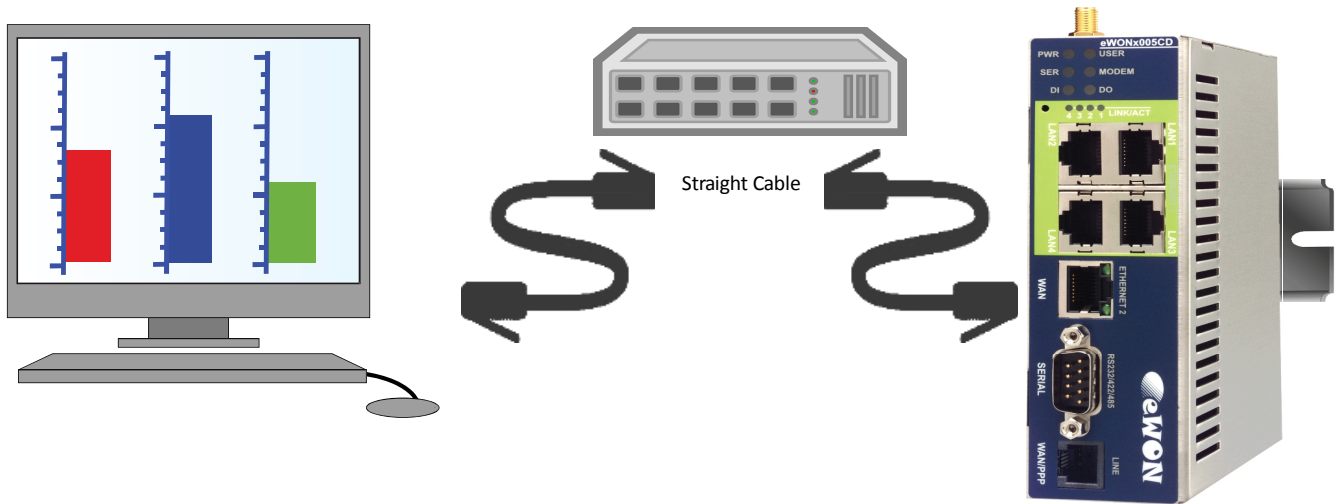

Again, the wiring is as shown on the following picture, and care should be taken to keep the RX and TX signals on twisted pairs

### A.5 - RJ-45 Connector

The RJ45 connector has got the following pins numbering, as it can be seen on the following picture, showing it from different angles:

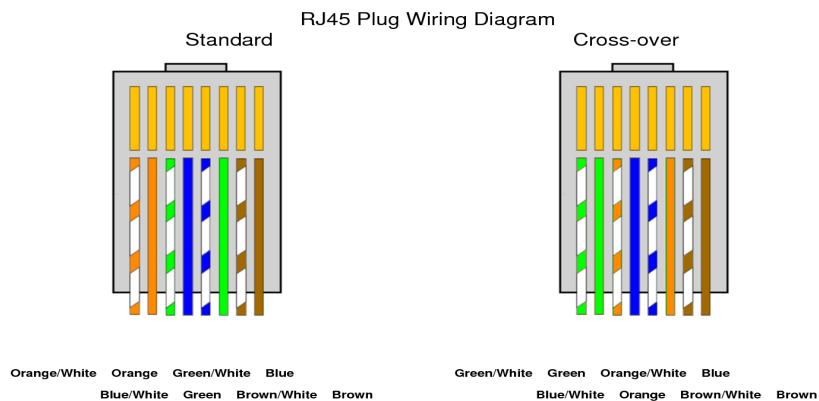



## A.6 - Inputs/Outputs

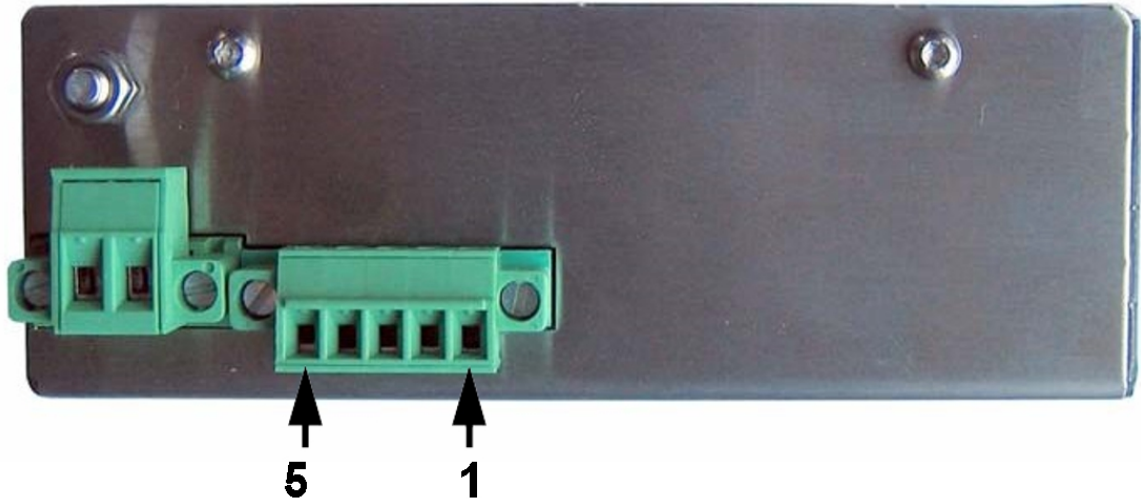

Mating female connector (included):

Manufacturer :  
Sauro  
<http://www.sauro.net/>  
Part Number: CTF050VT

Pin Position	REF	Description
1	DO-GND	Output digital signal (0V ground) connected to the emitter of the transistor
2	DO	Output digital signal connected to the drain of the MOSFET transistor
3	DO-VDC	Common of the external predrive Power Supply Between +12 & +24 VDC
4	DI_GND	Ground of the input "Isolated"
5	DI	Input digital signal

### A.7 - Serial Port

Mating female connector (not included):

Type:  
Female DB9 with 4/40 blocking screws



Pin-out Serial port (according to mode):

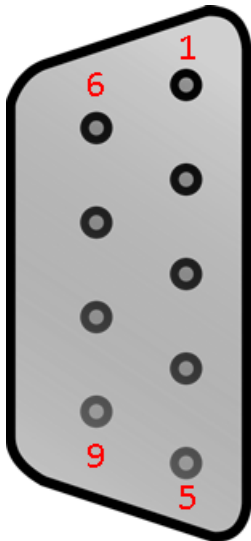

PIN	RS232	RS485	RS422
1	-	-	-
2	RXD	-	RX +
3	TXD	A +	TX +
4	-	-	-
5	GND	GND	GND
6	-	-	-
7	RTS	-	RX -
8	CTS	B -	TX -
9	-	-	-

### A.8 - MPI Port

Mating male connector (not included):

Type:  
Male DB9 with 4/40 blocking screws



MPI port pin-out (DB9 female):

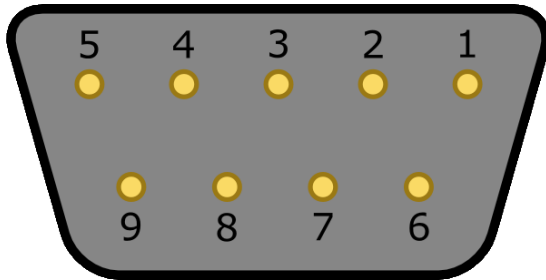

PIN	MPI
1	-
2	-
3	B (+)
4	-
5	GND
6	-
7	-
8	A (-)
9	-

### A.9 - PSTN/ISDN Phone line connector

Mating male connector (not included):

Type:  
RJ11 type "6P2C" without shield



PIN-out PSTN	
PIN	Description
1	-
2	-
3	TIP
4	RING
5	-
6	-

PIN-out ISDN	
PIN	Description
1	-
2	TX +
3	RX +
4	RX -
5	TX -
6	-

The ISDN modem in the appliance shall be connected to the telephone line via an ISDN adapter with adequate insulation from TNV3.

## A.10 - Antenna

Connector specifications:

For eWON with GSM/GPRS/EDGE/HSUPA modem, the antenna connector is placed on the top of eWON.

Specification	Value
Type	SMA-F
Tightening Torque	MAX 0.5N.m (manual tightening should be used as a reference)



Antenna specifications:

For eWON with GSM/GPRS/EDGE/HSUPA modem, the antenna specification is as follows:

Specification	Value
Type	Quad-band 850/900/1800/1900 MHz
Impedance	50 Ohms

Devices conformity has been assessed with the reference antenna : Kinsun 6602G01081.

eWON reference for the antenna is **EW40923** or **EW40922** for the antenna with a 2 meters length extension cable.

The use of different antenna may affect the compliance of the product.

### - Important -

The antenna used for this transmitter has to be installed to provide a distance of at least 20 cm from any person and may not be co-located or operating in conjunction with any other antenna or transmitter.

Also refer to the [Safety, Environmental & Regulatory information](#).

**A.11 - Antenna for HSUPA EW2620B** *[Since S/N 1537-0108-xx included]*

Connector specifications:

For eWON with UMTS/HSUPA modem,

the antenna connector is placed on the top of eWON.



Specification	Value
Type	SMA-F
Tightening Torque	MAX 0.5N.m (manual tightening should be used as a reference)

Antenna specifications:

For eWON with UMTS/HSUPA modem (EW2620B), the antenna specification is as follows:

Specification	Value
Type	Penta band 850/900/1700/1900/2100MHz
Impedance	50 Ohms

For products with Penta-band HSUPA modem, the conformity assessment has been performed with the reference antenna : Taoglas TG.09.0113.

eWON reference for the antenna is **FAC90501\_0000** or **FAC90501\_0100** for the antenna with a 2 meters length extension cable.

The use of different antenna may affect the compliance of the product.

Absolute maximum antenna gain as per FCC's rules and regulations, 47 CFR :

- Parts 22H : 5.22dBi;
- Parts 27 : 3.31dBi;
- Parts 24E : 6.45dBi.

**- Important -**

The antenna used for this transmitter has to be installed to provide a distance of at least 20 cm from any person and may not be co-located or operating in conjunction with any other antenna or transmitter.

Also refer to the [Safety, Environmental & Regulatory information](#).

## Revision

### Revision History

Revision Level	Date	Description
1.0	13/09/2013	Original Document
1.8	10/12/2015	New template + Up-to-date mode information about the EW4620B
1.9	27/07/2016	Update of Legal References

#### Document build number: 42

#### Note concerning the warranty and the rights of ownership:

The information contained in this document is subject to modification without notice. Check <http://support.ewon.biz> for the latest documents releases.

The vendor and the authors of this manual are not liable for the errors it may contain, nor for their eventual consequences.

No liability or warranty, explicit or implicit, is made concerning the quality, the accuracy and the correctness of the information contained in this document. In no case the manufacturer's responsibility could be called for direct, indirect, accidental or other damage occurring from any defect of the product or errors coming from this document.

The product names are mentioned in this manual for information purposes only. The trade marks and the product names or marks contained in this document are the property of their respective owners.

This document contains materials protected by the International Copyright Laws. All reproduction rights are reserved. No part of this handbook can be reproduced, transmitted or copied in any way without written consent from the manufacturer and/or the authors of this handbook.

eWON sa