

Plastic bodied limit switch Series I88

Description **I88-U1 AV VS**

Article number **6186136127**

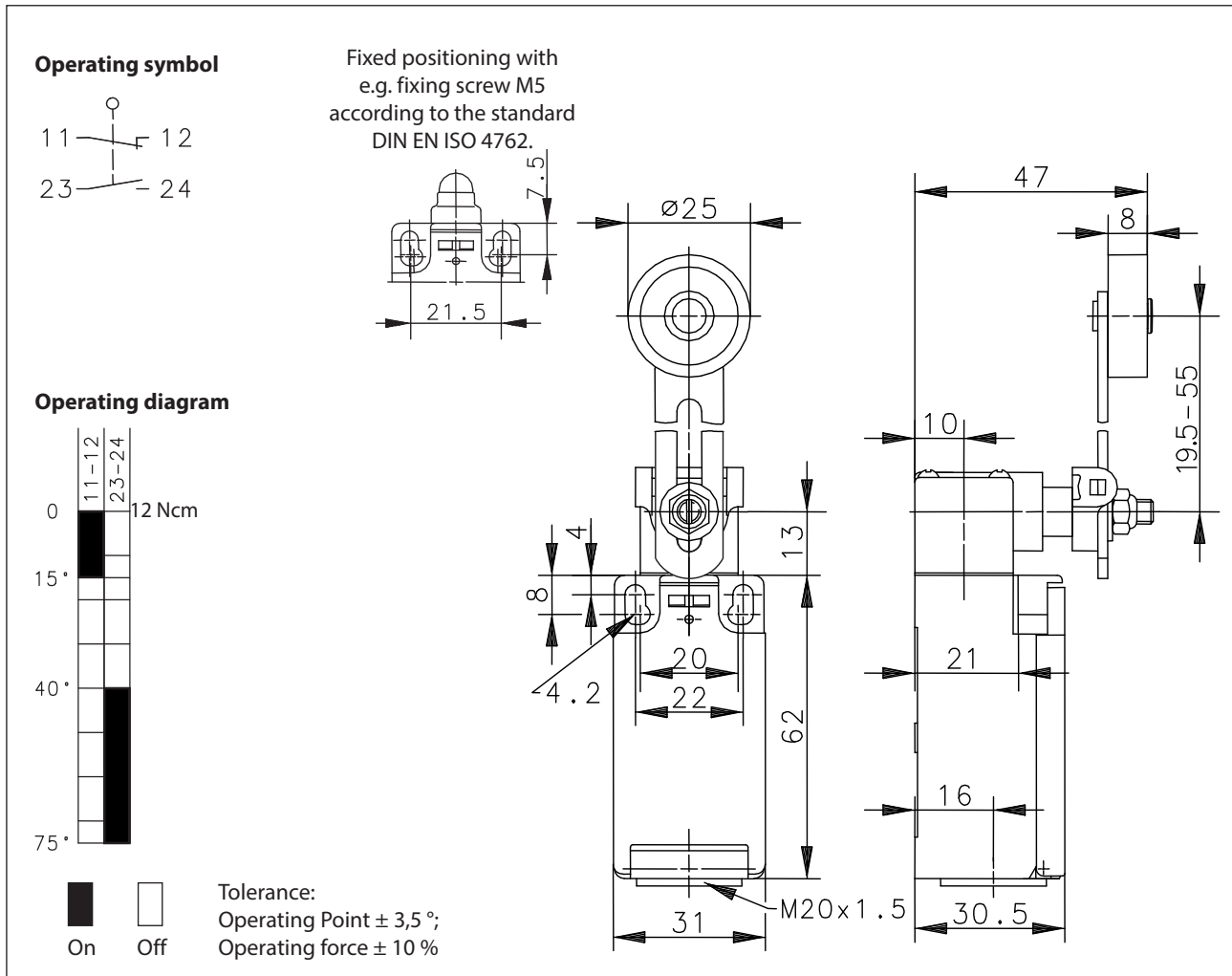

Electrical Data		
Rated insulation voltage	U_i	250 V AC
Conv. thermal current	I_{the}	10 A
Rated operational voltage	U_e	240 V
Utilization category		AC-15, U_e / I_e 240 V / 3 A
Short-circuit protective device		Fuse 10 A gG
Protection class		II (totally insulated)

Mechanical data	
Enclosure	Thermoplastic, glass fibre reinforced (UL 94-V0)
Cover	Thermoplastic, glass fibre reinforced (UL 94-V0)
Actuator	Turret head, lever (st), roller (thermoplastic)
Ambient air temperature	-30 °C ... +80 °C
Contact type	1 NC, 1 NO (Zb)
Mechanical life	10 x 10 ⁶ operating cycles
Switching frequency	≤ 100 / min.
Assembly	2 x M4
Connection	4 screw connections (M3,5)
Conductor cross-sections	Solid: 0,5 ... 1,5 mm ² or Litz wire with ferrules: 0,5 ... 1,5 mm ²
Cable entrance	1 x M20 x 1,5
Weight	≈ 0,11 kg
Installation position	operator definable
Protection type	IP65 acc. to IEC/EN 60529

Actuation
<p>The actuating device is preferably started from 2 sides. By loosening the 4 screws the actuation assembly can be rotated in 90 degree increments such that 8 actuation directions are possible. The actuation assembly is to be again fastened to the housing using the 4 screws.</p>

Standards
VDE 0660 T100, DIN EN 60947-1, IEC 60947-1
VDE 0660 T200, DIN EN 60947-5-1, IEC 60947-5-1

EU Conformity
acc. to directive 2006/95/EC

Approvals
cCSA _{US} A300 (same polarity)

Notes
The degree of protection (IP code) specified applies solely to a property closed cover and the use of an equivalent cable gland with adequate cable.