

Powering Business Worldwide

Solenoid Operated Directional Valve

DG4V-3-70 Design

1. Product introduction and target applications

DG solenoid valves are used in hydraulic circuits to start, stop and direct flow. With electronics on board, the DG4V3-Z-70 enables new machine control solutions, eliminating solenoid power shifting in the controls cabinet.

The DG4V3 – 70 series valve takes advantage of contemporary electronics and wiring practices applied in automation solutions world wide. Using industry standard M12 connectors and with the optional on board switching amplifier the – 70 series valve offers OEMs and users opportunity to simplify the electronics, and increase throughput by specifying preassembled and pre-wired electro-hydraulic manifold assemblies. This valve with on-board electronics has passed water immersion tests, qualified to IP67, and EMC testing to CE requirements. The rugged

construction, designed and qualified by Eaton with key features such as plug in coils, M12 connector and multiple coil wattages, meeting major automotive plant specifications, makes this valve a natural for global projects.

This solenoid valve is the latest in a long line of recognized Eaton brand DG valve series. The – 70 series valve builds on the proven – 60 series valve, adding connectivity and functionality tailored for state of the art 24 VDC machine control system. This product is available from and supported by Eaton and an extensive network of qualified distribution partners world wide.

2. Functional description

Electronics are housed in a robust metal housing sealed to IP67 environmental ratings and meeting CE standards for Electromagnetic Compliance.

- **Standard features** include surge suppression and LED's indicating voltage to the active coil.
- **The "Z" option adds the switching amplifier on board**, eliminating the cost and heat associated with having this function in the machine controls cabinet. 24 VDC power is supplied separately to pin1 of the M12 connector, while pin 2 or 4 control the solidstate switch connection to either solenoid A or B. Pin 3 is common.

3. Summary Features and Benefits

Hydraulic

Mounting interface: ISO 4401 size 03, ANSI/B93.7M size 3, CETOP RP65H, size 3, DIN 24340, NG 6

Maximum pressure: 350 bar (5000 psi) P, A and B ports.
210 bar (3000 psi) T port

Maximum flow: up to 80 l/m (21 USgpm) depending on spool type and coil wattage.

Environmental

IP 65 rated protection from low pressure water jets from all directions. IP 67 rated, water immersion tested.

EMC qualified to EN 61326 CE certified, CE mark on the valve.

Electrical

- 24 VDC operation only
- M12 connection.
- Coil control options, described on page 9:
 - A-option, direct connection from the M-12 connector to each coil. (Model code pos 9)
 - Z-option, On Board Switching amplifier.

Information on available coil power levels and commands required to operate the on board switching amplifier is in section 5, Technical Specifications.

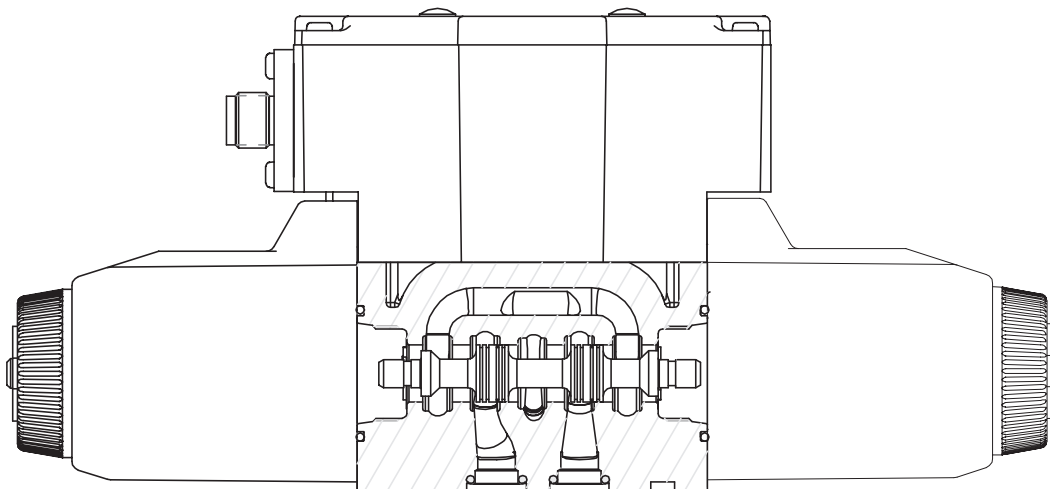

Cross Sectional View

Model Code

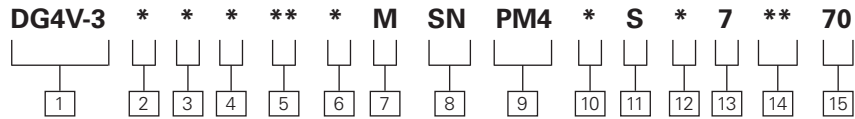

1 Directional Control Valve

- 4** – Solenoid operated,
- V** – Pressure rating 350 bar (5000 psi) on P, A & B ports
- 3** – ISO4401 Size 03

2 Spool Type

See “Functional Symbols” Section on page 4

3 Spool/Spring Arrangement Single solenoid models

- A** – Spring offset, Right hand build (standard)
- AL** – Spring offset, Left hand build (optional)
- B** – Spring centered, Right hand build (standard)
- BL** – Spring centered, Left hand build (optional)
- Dual solenoid models**
- C** – Spring centered. No R or L option
- N** – No spring detented. No R or L option.

4 Manual Override

- P** – Plain overrides in solenoid ends only (standard)
- H** – Waterproof override in solenoid ends only
- W** – Twist and lock manual override (not available in “F6” models)
- Z** – No overrides in either end

5 Seal Type

- F3** – Viton Seals (standard)
- F6** – Buna Nitrile/High CAN

6 Solenoid Energization Identity

- A** – Solenoid identification based on ANSI B93 9 (i.e. energize solenoid A TO GIVE flow P to A) (standard)
- V** – Solenoid identification determined by position of solenoid (i.e. solenoid ‘A’ at port ‘A’ end, solenoid ‘B’ at port ‘B’ end). Required for 8C-type spool.

7 Flag Symbol

- M** – Electrical options and feature

8 Spool Indicator Switch

- SN** – No Switch (standard)

9 Electrical Connector

- PM4** – 4 Pin M12 Connector

10 Wiring Convention

- A** – Pins 2, 3 & 4 direct connection used
- Z** – On board switching amplifier

11 Configuration

- S** – Standard configuration (diodes and lights included)

12 Coil Rating

- H** – 24 VDC, 30W
- HL** – 24 VDC, 18W
- HM** – 24 VDC, 10W

13 Tank Pressure Rating

- 7** – 210 Bar

14 Orifice Plugs

- NP** – No Port Orifices (standard)
- P**** – Orifice in “P” port
- A**** – Orifice in “A” port
- B**** – Orifice in “B” port
- T**** – Orifice in “T” port

Sizes (the “” above):**

- 03** – 0.30 orifice dia
- 06** – 0.60 orifice dia
- 08** – 0.80 orifice dia
- 10** – 1.00 orifice dia
- 13** – 1.30 orifice dia
- 15** – 1.50 orifice dia
- 20** – 2.00 orifice dia
- 23** – 2.30 orifice dia
- 25** – 2.50 orifice dia
- 30** – 3.00 orifice dia
- 35** – 3.50 orifice dia.

15 Design Number

- 70** – Design Number



Functional Symbols

Spool Options

D

The valve function schematics apply to both U.S. and European valves.

DG4V-3(S)-*N(V)

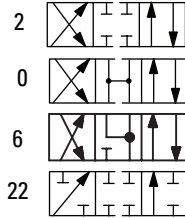

DG4V-3(S)-*A(V)

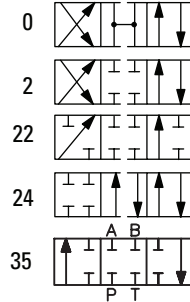

DG4V-3(S)-*AL(V)

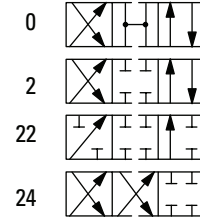

DG4V-3(S)-*C(V)

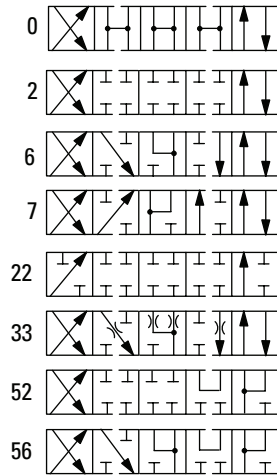

DG4V-3(S)-*B/F(V)

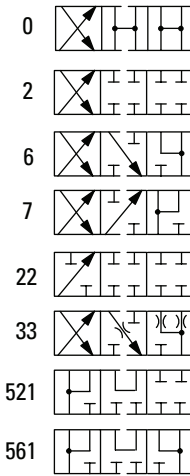

DG4V-3(S)-*BL/FL(V)

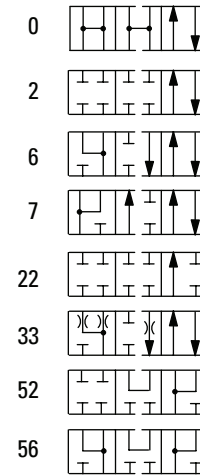

DG4V-3(S)-8C(V)

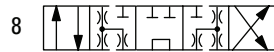

DG4V-3(S)-8BL(V)

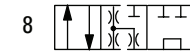

DG4V-3(S)-8B(V)

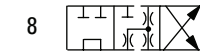

Solenoid Identified to US and European Standards

	U.S. Solenoid Standard	European Solenoid Standard (specify "V" in the model code)
Double solenoid valves, two position, detented		
Double solenoid valves, spring centered		
Single solenoid valves, solenoid at port A end		
Single solenoid valves, solenoid at port B end		

▲ Transient condition only

Operating Data

Solenoid Identified to US and European Standards

Feature	DG4V-3		
Pressure Limits			
P, A and B ports	350 bar (5075 psi)		
T port:	210 bar (3045 psi)		
Flow rating	See performance data		
Relative duty factor	Continuous; ED = 100%		
Type of protection: ISO 4400 coils with plug fitted correctly	IEC 144 class IP65		
Coil winding	Class H		
Coil encapsulation	Class F		
Permissible voltage fluctuation:			
Maximum	24 VDC \pm 10%		
Coil Designation	H	HL	HM
Typical response times at 100% rated volts measured from application/removal of voltage to full spool displacement of "2C" spool at:			
Flow rate P-A, B-T	40 l/min (10.6 USgpm)	25 l/min (6.6 USgpm)	25 l/min (6.6 USgpm)
Pressure	175 bar (2537 psi)	175 bar (2537 psi)	100 bar (1500 psi)
DC (=) energizing	60 ms	65 ms	85 ms
DC (=) de-energizing	33 ms	40 ms	40 ms
Power consumption, DC solenoids at rated voltage and 20 C (68 F).			
Full power coils:			
24V, model type "H"	30W	–	–
Low power coils:			
12V, model type "HL"	–	18W	–
24V, model type "HM"	–	–	10W
Weight			
Double solenoid	2.5 kg (5.5 lb) approx.		
Single solenoid	1.9 kg (4.2 lb) approx.		
Fluid cleanliness	9/17/14		
Temperature			
Fluid	-20 to + 70°C (-4 to +158°F)		
Ambient air	-20 to + 70°C (-4 to +158°F)		
Storage	-25 to + 85°C (-13 to +185°F)		

NOTE: For Fluid Recommendations refer Section Q of the catalog.

Performance Data

Typical with mineral oil at 36 cSt (168.6 SUS) and a specific gravity of 0.87.

Maximum flow rates

Performance based on full power solenoid coils warm and operating at 90% rated voltage.

H Type Solenoid- 30W

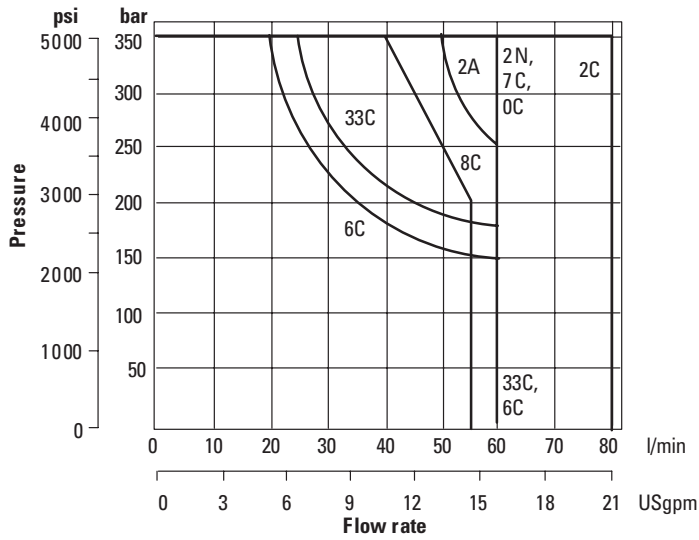

HL Type Solenoid- 18W- (Optional)

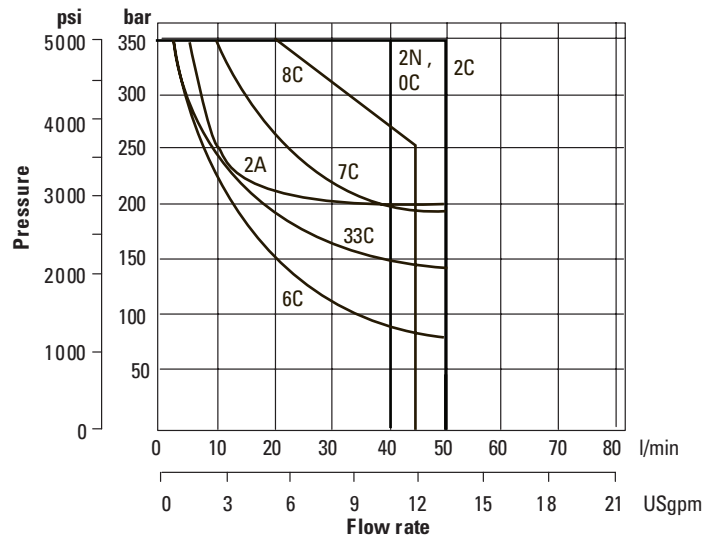

HM Type Solenoid- 10W- (Optional)

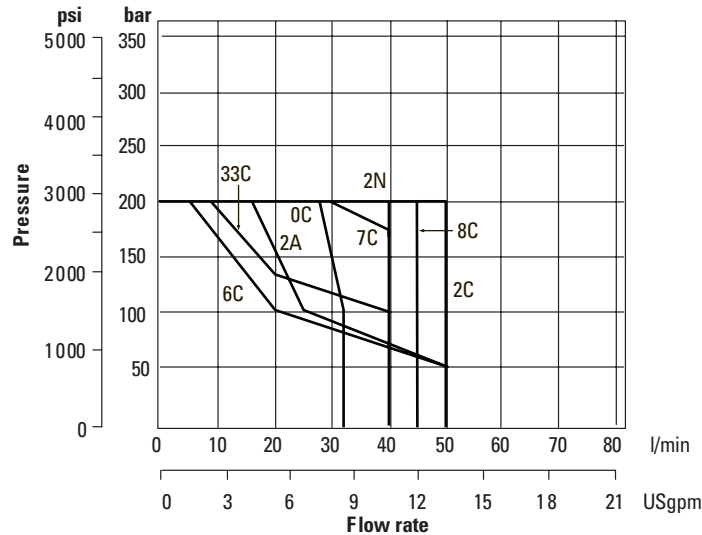

Pressure Drop Performance

Pressure Drop Curves by Spool Type

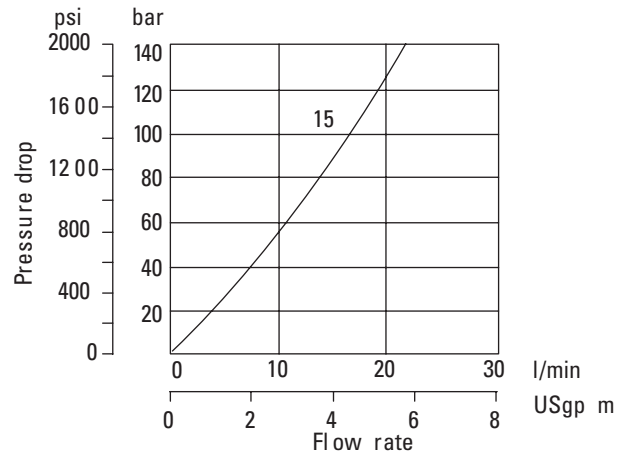
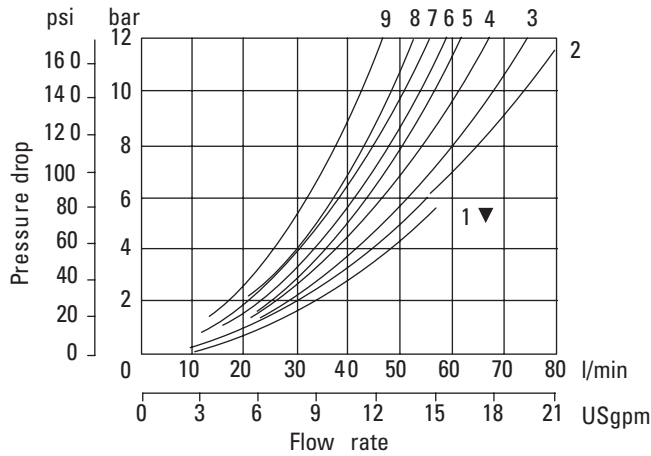

▼ Curve for spool type 6: not recommended for flows in excess of 60 l/min (15.8 USgpm).

Pressure drops in offset positions except where otherwise indicated.

Spool/Spring Code	Covered Spool Positions	P-A	P-B	A-T	B-T	P-T	B-A or A-B
0A(L)	Both	5	5	2	2	-	-
0B(L) & 0C, 0F	De-energized	-	-	-	-	4 ▲■	-
	Energized	4	4	2	2	-	-
2A(L)	Both	6	6	5	5	-	-
2B(L), 2C, 2F	Energized	5	5	2	2	-	-
2N (H and HL coil)	Both	6	6	3	3	-	-
2N (HM coil)	Both	8	8	5	5	-	-
6B(L), 6C, 6F	De-energized	-	-	3 ▲	3 ■	-	-
	Energized	6	6	1	1	-	-
7B(L), 7C, 7F	De-energized	6 ▲	6 ■	-	-	-	7○
	Energized	4	4	3	3	-	-
8B(L), 8C	All	9	9	5	5	3	-
33B(L), 33C	De-energized	-	-	15▲	15■	-	-
	Energized	5	5	2	2	-	-

▲ "B" plugged ■ "A" plugged ○ "P" plugged

For other viscosities, pressure drops approximate to:

Viscosity cSt (SUS)						
14	20	43	54	65	76	85
(17.5)	(97.8)	(200)	(251)	(302)	(352)	(399)
% of Δp						
81	88	104	111	116	120	124

A change to another specific gravity will yield an approximately proportional change in pressure drop.

The specific gravity of a fluid may be obtained from its producer. Fire resistant fluids usually have higher specific gravities than oil.

Installation Dimensions

D

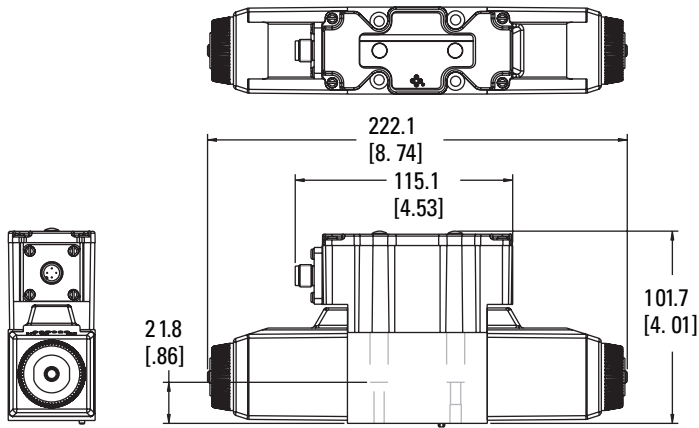

DG4V-3-***C/N** -*M-PM4*S-***7-70

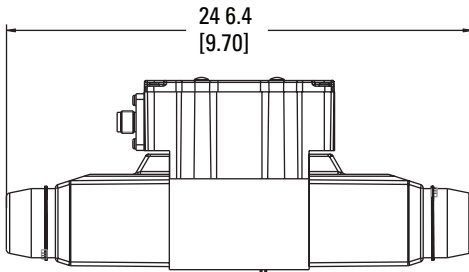

DG4V-3-***C/N-H** -*M-PM4*S-***7-70

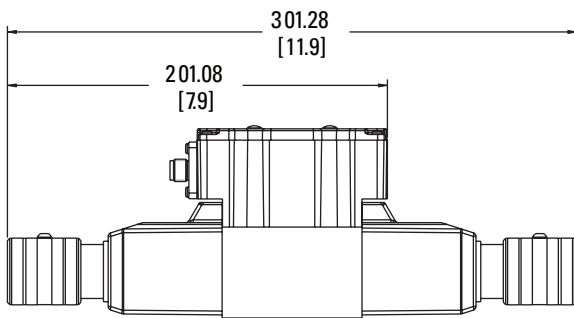

DG4V-3-*****(L)-W** -*M-PM4*S-***7-70

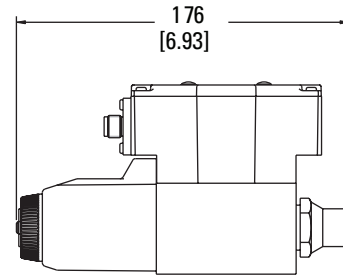

DG4V-3-*****A/B/F(L)-P2** -*M-PM4*S-***7-70

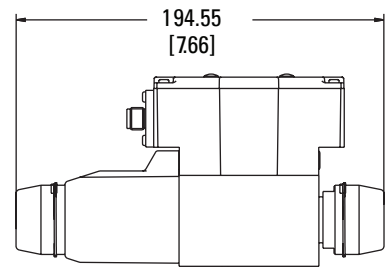

DG4V-3-***A/B/F(L)-H2** -*M-PM4*S-***7-70

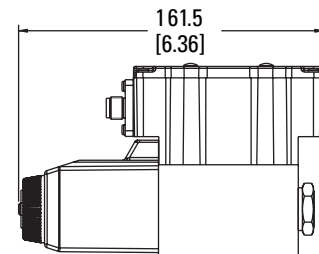

DG4V-3-***A/B/F(L)** -*M-PM4*S-***7-70

Electrical Specifications

Solenoid Indication Standard

LED is lit when there is power to the coil.

EMC Qualifications

to EN 61326

A-Option

Direct connected coil shown to the right.

Protection network for inductive loads protects the (machine control) switch from high voltages and speeds the de-energizing of the solenoid.

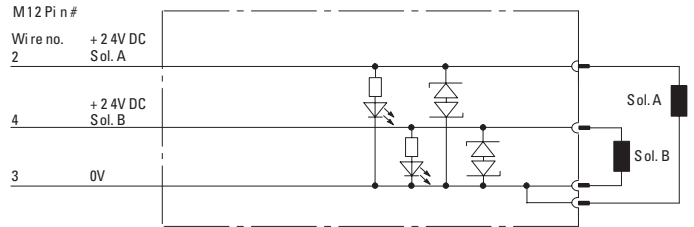

Z-Option

Switching Amplifier on Board shown to the right.

The circuit on the Z-option is reverse polarity protected. The output is short circuit protected. In case of a shorted solenoid, the amplifier will remove the voltage from it. When the short is removed the amplifier will restart automatically.

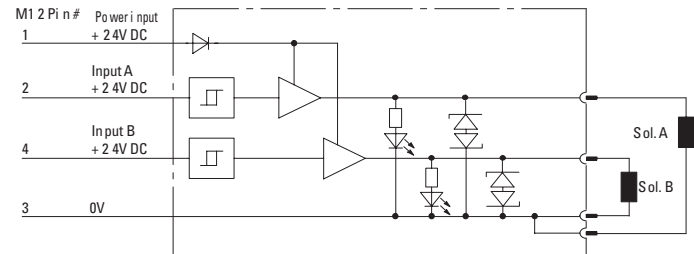

ELECTRICAL DATA:

For the "Z" option, switching amplifier version.

Power Supply	24 VDC +- 10% range
Control input	Per IEC 61131-2 for digital input type 2
Switching Frequency	2 Hz maximum
Range	-2 to +30V
ON condition	11 V and above. 6 mA at 11 V. Maximum 20 mA at 24 V
OFF condition	5 V and below. 2 mA at 5 V

M12 Connection

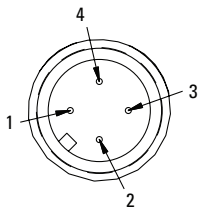

Pin 1 is only used on the Z option for 24 VDC power to the valve.

Pin 2 always controls ("Z" option) or power ("A" option) the solenoid on the "B" port side of the valve.

Pin 3 is always common or 0 volt, both A and Z control option.

Pin 4 always controls ("Z" option) or power ("A" option) the solenoid on the "A" port side of the valve.

CONTROL OPTION	PIN NUMBER	CONNECTION REF DESTINATION
PM4AS	1	No Connection
"A" Option	2	Power, Solenoid on B-Port Side
	3	Common, Sol A & B-
PM4ZS	4	Power, Solenoid on A-Port Side
	1	Power Supply
"Z" Option	2	Control Input, Solenoid on B-Port Side
	3	Common, 0V
	4	Control Input, Solenoid on A-Port Side

Note: For left hand builds ("L" in model code pos 3) pin connection to port A and B will be reversed.

WARNING:

Electromagnetic Compatibility (EMC)

It is necessary to ensure that the valve is wired up in accordance with the connection arrangements shown in this leaflet.

For effective protection, the user's electrical cabinet, the valve subplate or manifold and the cable screens should be connected to efficient ground points.

In all cases, both valve and cable should be kept as far away as possible from any source of electromagnetic radiation such as cables carrying heavy current, relays and certain kinds of portable radio transmitters, etc.

Difficult environments could mean that extra screening may be necessary to avoid interference.

Eaton
Hydraulics Group USA
14615 Lone Oak Road
Eden Prairie, MN 55344
USA
Tel: 952-937-9800
Fax: 952-294-7722
www.eaton.com/hydraulics

Eaton
Hydraulics Group Europe
Route de la Longeraie 7
1110 Morges
Switzerland
Tel: +41 (0) 21 811 4600
Fax: +41 (0) 21 811 4601

Eaton
Hydraulics Group Asia Pacific
Eaton Building
4th Floor, No.7 Lane280 Linhong Rd.
Changning District
Shanghai 200335
China
Tel: (+86 21) 5200 0099
Fax: (+86 21) 2230 7240

© 2015 Eaton
All Rights Reserved
Printed in USA
Document No.: E-VLDI-BB004-E
April 2015