

## Plunger valve 3/2 way direct-acting

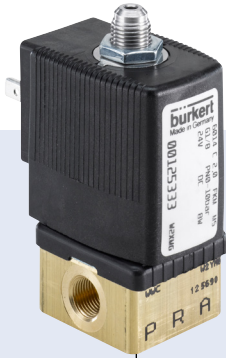

Type 6014 can be combined with...



Type 2513



Type 2511



Type 2508

- Direct-acting, compact valve with diameter of up to DN2.5
- Vibration-proof, bolted coil system
- Banjo threaded connection for direct mounting on pneumatic valves
- Service-friendly manual override
- Energy-saving pulse versions

Valve 6014 is a direct-acting plunger valve. The stopper and plunger guide tube are welded together to enhance pressure resistance and leak-tightness. Various seal material combinations are available depending on the application. A Bürkert-specific flange design (SFB) enables space-saving arrangement of valves on a manifold. The coils are moulded with polyamide or with chemically resistant epoxy. Pulse coils are available for the reduction of electrical power consumption during operation. Optional manual actuation enables quick commissioning and easy maintenance. In combination with a plug in accordance with DIN EN 175301-803 Form A, the valves satisfy protection class IP65. Stainless steel valves satisfy NEMA 4X.

Technical data	
<b>Body material</b>	Brass or stainless steel, polyamide (sub-base)
<b>Seal material</b>	FKM (EPDM on request)
<b>Medium</b>	Neutral gases and fluids (e.g. compressed air, town gas, natural gas, water, hydraulic oil, petrol). Suitable for technical vacuum
<b>Medium temperature</b> Polyamide coil (FKM seal)	-10° to +100 °C (PA coil) to 120 °C Epoxy coil
<b>Ambient temperature</b>	Max. +55 °C
<b>Viscosity</b>	Max. 21 mm <sup>2</sup> /s
<b>Port connection</b>	G 1/8, G 1/4, sub-base (SFB)
<b>Operating voltage</b>	24 V DC, 24 V/50 Hz, 230 V/50 Hz (other voltages on request)
<b>Voltage tolerance</b>	± 10 %
<b>Duty cycle / single valve</b> Assembly	100 % continuous rating Intermittent operation 60 % (30 min) or with 5 W coil (on request)
<b>Electrical connection</b>	DIN EN 175 301-803 Form A for Cable Plug, Type 2508 (see Ordering chart for accessories) ATEX/IECEx version with 3 m moulded cable
<b>Installation</b>	As required, preferably with actuator upright
<b>Protection class</b>	IP65 with cable plug, ATEX/IECEx junction box version and cable connection version NEMA 4x with cable plug 2508 or 2509 only for stainless steel versions (other versions on request)
<b>Coil insulation class</b>	Polyamide class B (Epoxy class H on request)
<b>Coil material</b>	Polyamide (Epoxy on request)
<b>Orifice</b>	DN1.5 ... 2.5

### Circuit function C

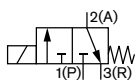

3/2 way direct-acting solenoid valve, normally closed

### Circuit function D

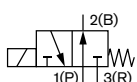

3/2 way direct-acting solenoid valve, normally open

### Circuit function T

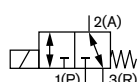

3/2 way direct-acting solenoid valve, flow direction optional

## Technical data

### Power consumption

Orifice [mm]	Power consumption			
	Inrush AC [VA]	Hold AC (hot coil) [VA]	[W]	DC hot / cold coil [W]
1.5...2.5	24	17	8	8 / 9

### Response times

Orifice [mm]	Response times AC and DC	
	Opening [ms]	Closing [ms]
1.5	10 ... 15	15 ... 20
2.0	10 ... 15	15 ... 20
2.5	15 ... 20	10 ... 22

#### Response times [ms]:

Measured at valve outlet at 6 bar and +20 °C.

Opening: Pressure build-up 0 ... 90%, to

Closing: Pressure relief 100 ... 10%

## Materials

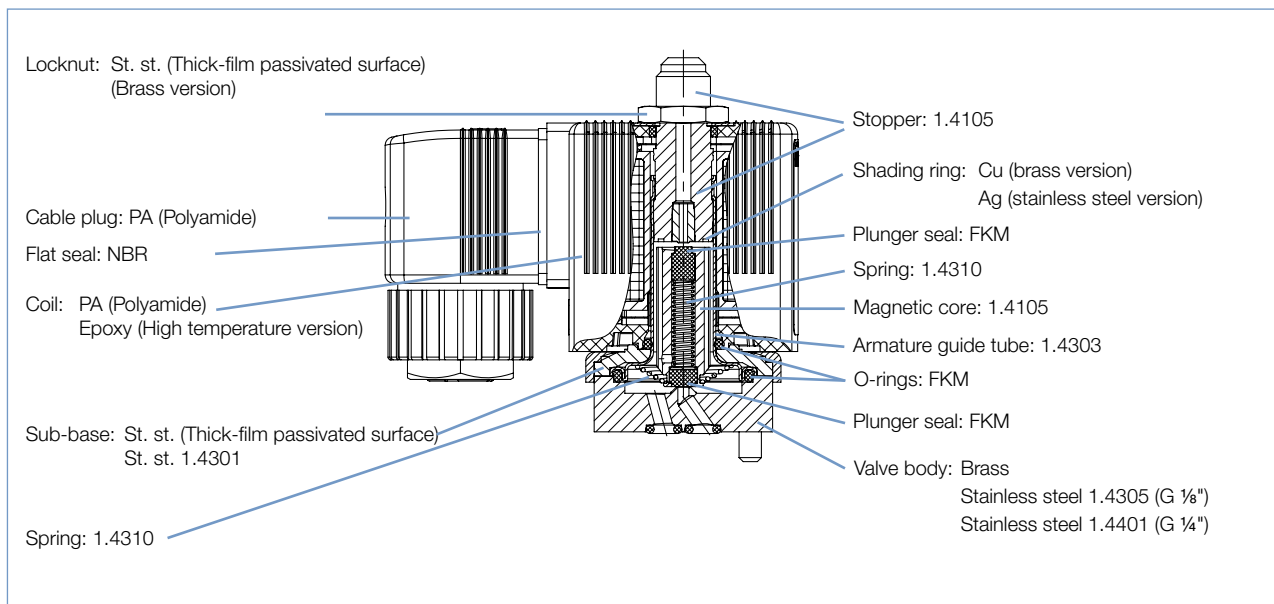

Dimensions [mm]

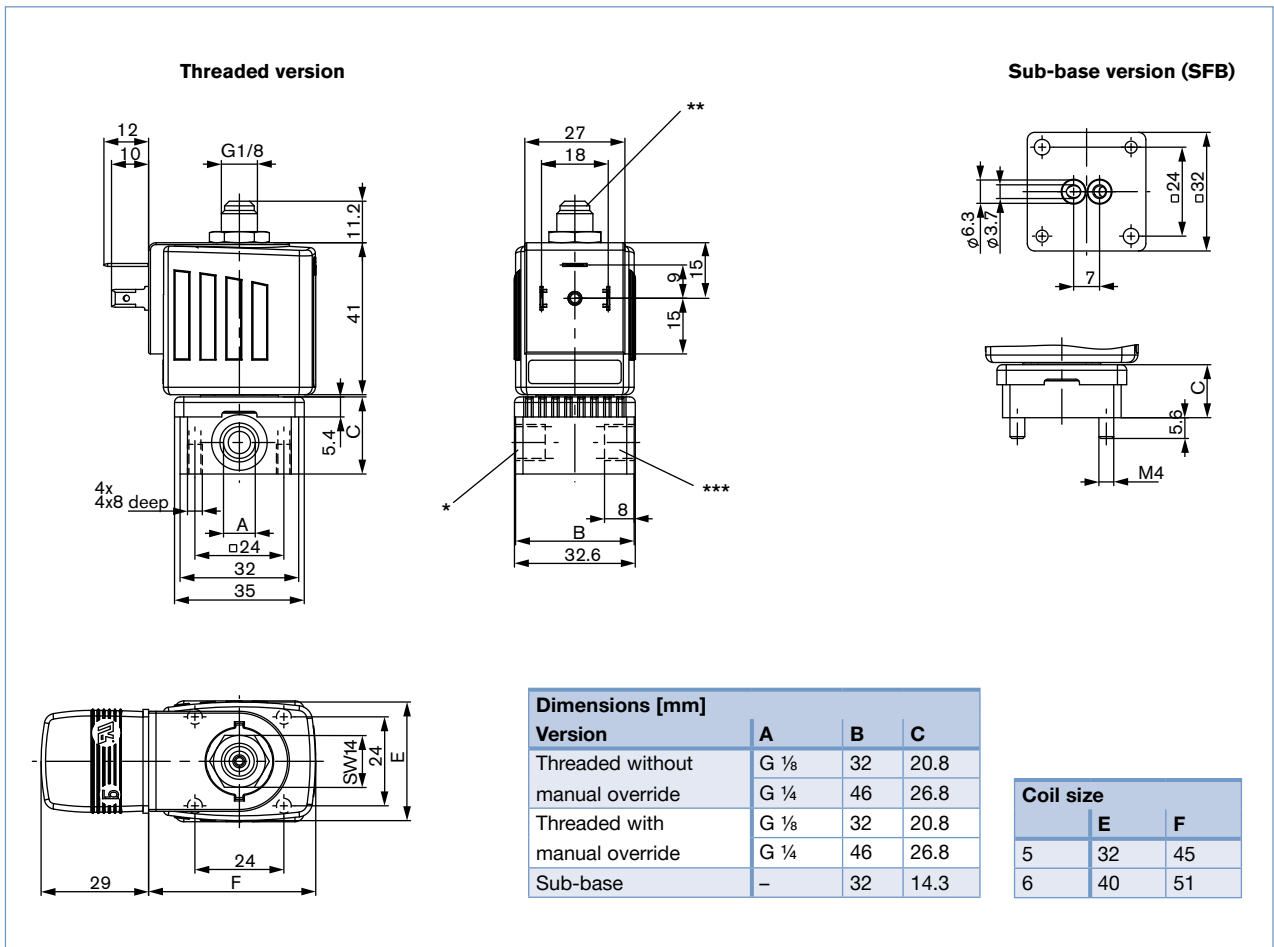

Utilisation in another circuit function

Valves with circuit functions (WW) C, D and T are fitted with different springs. If used in some other circuit function, the permissible operating pressure may change (see table below).

Valve Version Basic version		Max. operating pressure [bar] for valve application in circuit function				
DN	Circuit function	A	B	C	D	T
1.5	C	16	22	16	2	2
	D	2	2.5	2	16	2
	T	10	16	10	6	6
2.0	C	10	14	10	1	1
	D	1	1.5	1	10	1
	T	6	10	6	4	4
2.5	C	6	9	6	0.7	0.7
	D	0.7	1	0.7	6	0.7
	T	3.5	6	3.5	2.5	2.5

Connections

For the positions marked with \*, \*\* or \*\*\* in the drawing, the connections are marked with the letters shown in the table above, depending on the circuit function. Unused connections in circuit functions A or B will be closed off with a blanking plug or cap nut.

Circuit function	Connection Type		
	*	**	***
A	P	blank off	A
B	blank off	B	P
C	P	R	A
D	R	P	B
T	P	R	A

- see drawing on page 7

## Ordering chart for valves (other versions on request)

## 6014 Threaded valves with FKM seal, (class B)

Delivered without cable plug (see accessories)

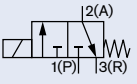
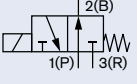
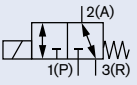
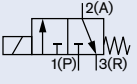
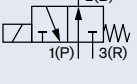
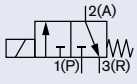
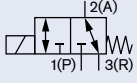









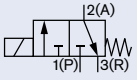





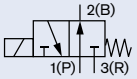



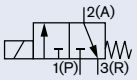







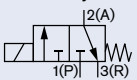

Circuit function	Orifice [mm]	Port connection	K <sub>v</sub> value water [m <sup>3</sup> /h] <sup>1)</sup>	Pressure range [bar] <sup>2)</sup>	Effective coil power [W]	Article no. per voltage / frequency		
						024/DC	024/50	230/50
<b>Brass body</b>								
<b>C</b> 3/2 way valve NC 	1.5	G 1/8	0.07	0 ... 16	8	125329	125331	125332
	2.0	G 1/8	0.11	0 ... 10	8	125333	125334	125336
		G 1/4	0.11	0 ... 10	8	125348	126138	126140
	2.5	G 1/8	0.16	0 ... 6	8	125341	125340	125342
G 1/4		0.16	0 ... 6	8	126142	126143	126145	
<b>D</b> 3/2 way valve, NO 	1.5	G 1/8	0.07	0 ... 16	8	126195	126196	125355
	2.0	G 1/8	0.11	0 ... 10	8	125357	125358	125360
		G 1/4	0.11	0 ... 10	8	126198	126199	126201
	2.5	G 1/8	0.16	0 ... 6	8	125363	126202	126204
G 1/4		0.16	0 ... 6	8	126205	126206	126208	
<b>T</b> 3/2 way Universal valve 	1.5	G 1/8	0.07	0 ... 7	8	126150	126151	126153
<b>with manual override</b>								
<b>C</b> 3/2 way valve NC 	2.0	G 1/8	0.11	0 ... 10	8	125337	125338	125339
		G 1/4	0.11	0 ... 10	8	125349	126147	126149
<b>D</b> 3/2 way valve, NO 	2.0	G 1/8	0.11	0 ... 10	8	126209	125361	126211
		G 1/4	0.11	0 ... 10	8	126212	126213	126215
<b>Stainless steel body</b>								
<b>C</b> 3/2 way valve NC 	1.5	G 1/8	0.07	0 ... 16	8	126216	126217	126219
	2.0	G 1/8	0.11	0 ... 10	8	126220	126221	126223
		G 1/4	0.11	0 ... 10	8	126224	126225	126227
<b>T</b> 3/2 way, universal valve 	1.5	G 1/8	0.07	0 ... 7	8	126228	126229	126231

<sup>1)</sup> Measured at +20 °C, 1 bar<sup>2)</sup> pressure difference<sup>2)</sup> Measured as overpressure to the atmospheric pressure

## Ordering chart for valves (other versions on request)

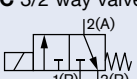
## 6014 Valves with FKM seal and sub-base body (SFB), (class B)

Delivered without cable plug (see accessories)

Circuit function	Orifice [mm]	K <sub>v</sub> value water [m <sup>3</sup> /h] <sup>1)</sup>	Pressure range [bar] <sup>2)</sup>	Effective coil power [W]	Article no. per voltage / frequency		
					024/DC	024/50	230/50
<b>Brass body</b>							
<b>C</b> 3/2 way valve NC 	1.5	0.07	0...16	8	126154 	126155 	125366 
	2.0	0.11	0...10	8	125367 	125368 	125370 
<b>D</b> 3/2 way valve, NO 	2.0	0.11	0...10	8	126161 	126162 	125383 
<b>with manual override</b>							
<b>C</b> 3/2 way valve NC 	1.5	0.07	0...10	5	126403 	126404 	126406 
	1.5	0.07	0...16	8	126157 	126158 	126160 
	2.0	0.11	0...6	5	126407 	126408 	126410 
	2.0	0.11	0...10	8	125371 	125372 	125374 
<b>Polyamide body material</b>							
<b>C</b> 3/2 way valve NC 	1.5	0.07	0...10	5	126390 	126391 	126393 
<b>with manual override</b>							
<b>C</b> 3/2 way valve NC 	1.5	0.07	0...10	5	126396 	126397 	126399 

<sup>1)</sup> Measured at +20 °C, 1 bar<sup>2)</sup> pressure difference<sup>2)</sup> Measured as overpressure to the atmospheric pressure

## Ordering chart for valves, impulse version (other versions on request)

## 6014 impulse valve with FKM seal material and brass body (class H)

Circuit function	Port connection	Orifice [mm]	K <sub>v</sub> value water [m <sup>3</sup> /h] <sup>1)</sup>	Pressure range [bar] <sup>2)</sup>	Power consumption DC (hot/cold coil) [W]	Article no. per voltage [V/]	
						012/DC	024/DC
<b>C</b> 3/2 way valve, output 2 exhausted 	<b>Brass body</b>						
	Threaded port G 1/8	1.5	0.07	0 ... 16	7	209280	209284
		2.0	0.11	0 ... 10	7	209281	209285
	Sub-base {SFB}	1.5	0.07	0 ... 16	7	209278	209282
2.0		0.11	0 ... 10	7	209279	209283	

<sup>1)</sup> Measured at +20 °C, 1 bar<sup>2)</sup> pressure difference

<sup>2)</sup> Measured as overpressure to the atmospheric pressure

## Activation of the impulse version with inverse polarity operation

The polarity is labelled on the valve	Specifications	Terminal connections
- switch ON +	valve will be opened	(+) on terminal 2 and (-) on terminal 1 (see below)
+ switch OFF -	valve will be closed	(+) on terminal 1 and (-) on terminal 2 (see below)

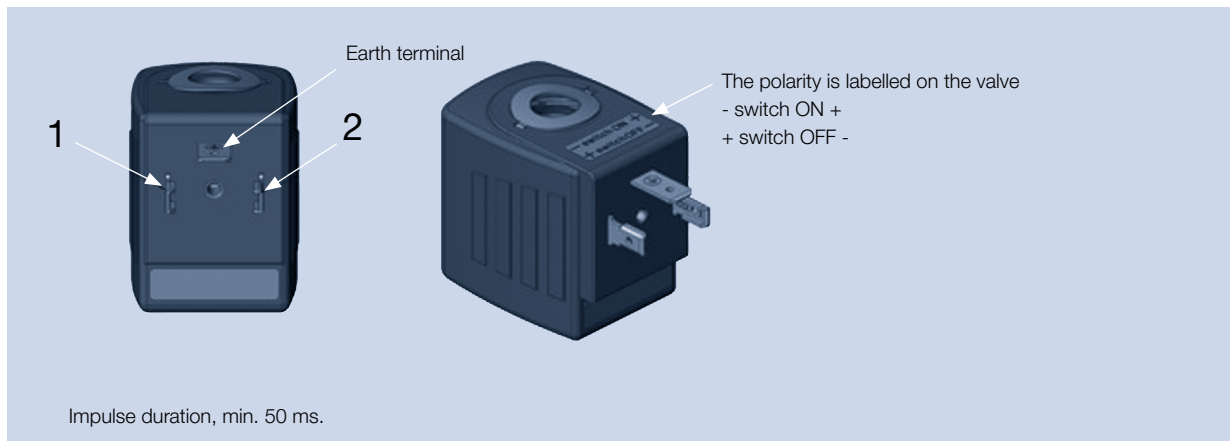

**Note:** Only cable plug without circuitry should be used together with impulse version!

## Materials for banjo version

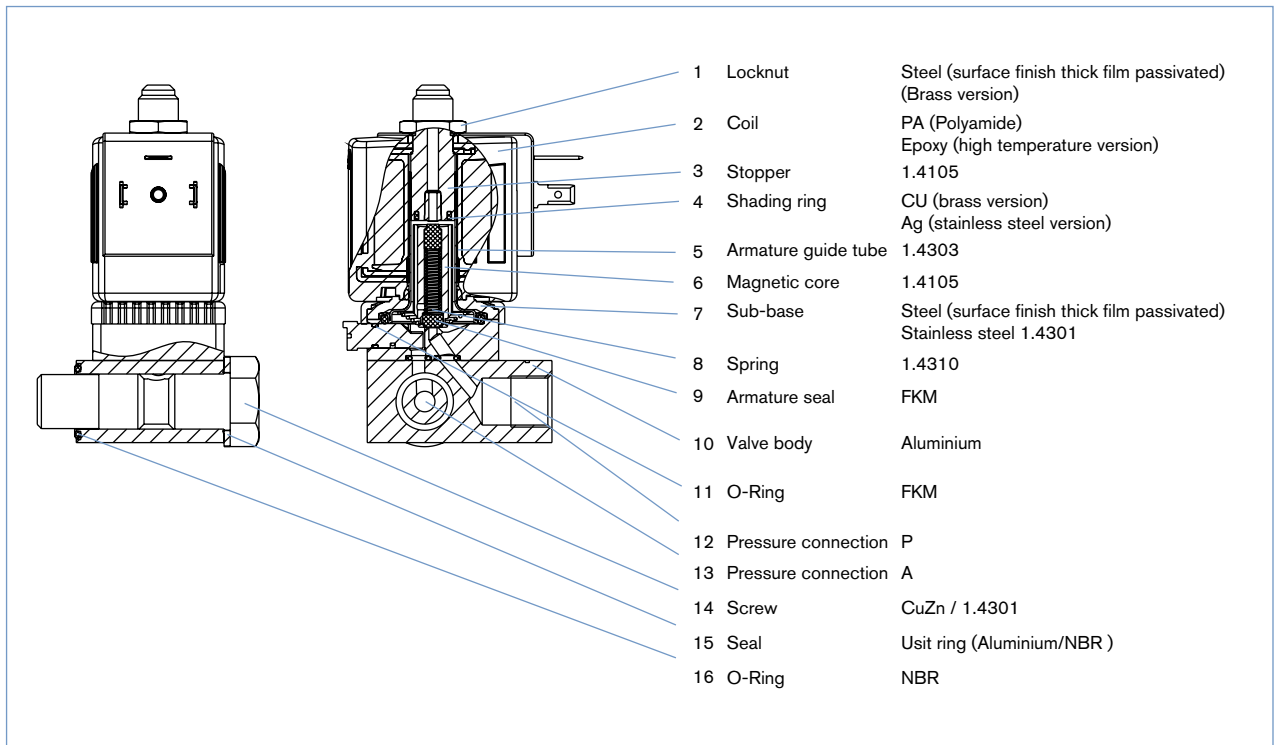

Dimensions for banjo version

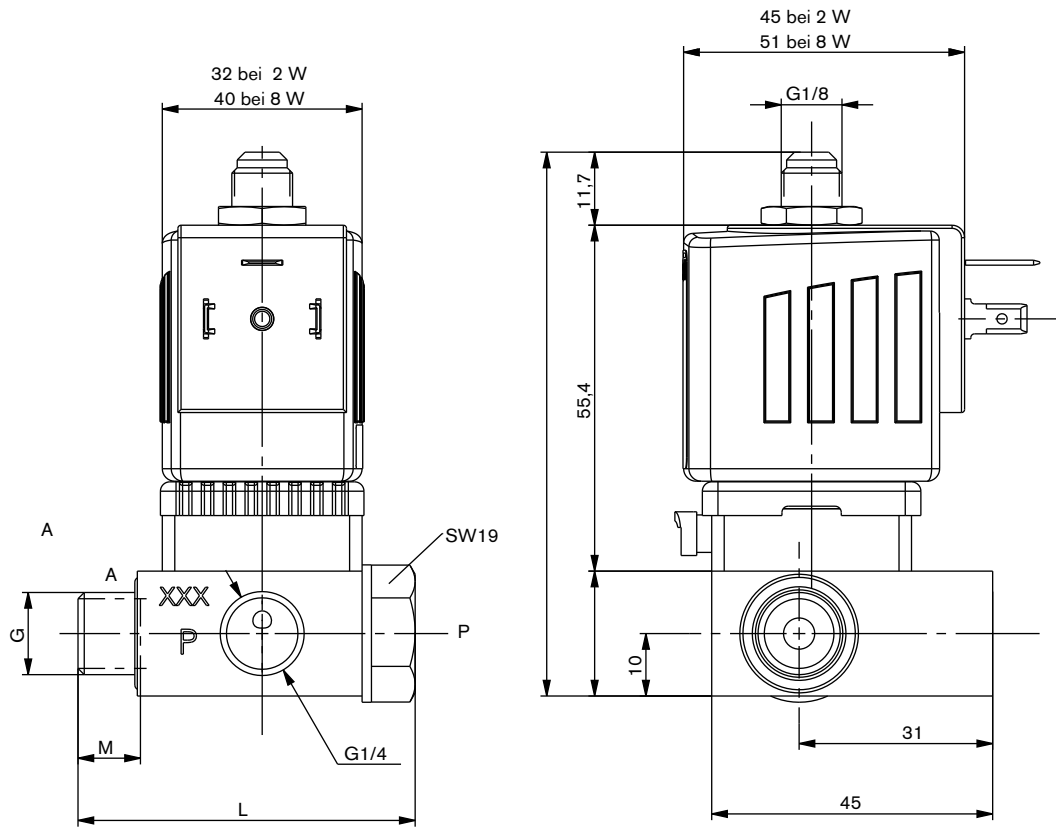

G	M	L
G 1/8	10	51
G 1/4	12	54

IXEF® Banjo coupler, anodised aluminium banjo bolt

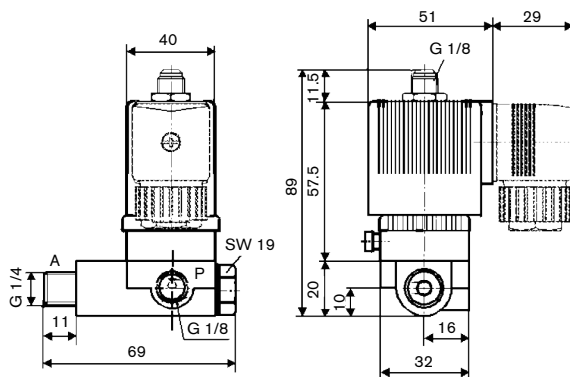



### Ordering chart for banjo version (other versions on requests)

All valves with FKM seal and manual override, delivered without cable plug  
Anodised aluminium banjo coupler, nickel-plated brass banjo bolt

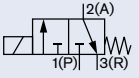
Circuit function	Pressure inlet P (banjo coupler)	Service port A (banjo bolt)	Orifice [mm]	Q <sub>Nn</sub> value air [l/min]	Material flange body	Pressure range [bar]	Power consumption [W]	Article no. per voltage/frequency [V/Hz]		
								024/DC	024/50	230/50
<b>C</b> 3/2 way valve NC 	G ¼	G ⅛	1.5	75	PA	0...6	2	424123	424124	424127
		G ¼	1.5	75	PA	0...6	2	424118	424119	424122
		G ⅛	2.0	120	Brass	0...10	8	424113	424114	424117
		G ¼	2.0	120	Brass	0...10	8	424103	424104	424107

**Please note** that the cable plug has to be ordered separately, see separate datasheet for Type 2508.

### Ordering chart for banjo version IXEF (other versions on requests)

All valves with PA body, FKM seal and manual override, delivered without cable plug  
IXEF® banjo coupler, anodised aluminium banjo bolt

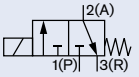
Circuit function	Pressure inlet P (banjo coupler)	Service port A (banjo bolt)	Orifice [mm]	Q <sub>Nn</sub> value air [l/min]	Material flange body	Pressure range [bar]	Power consumption [W]	Article no. per voltage/frequency [V/Hz]		
								024/DC	024/50	230/50
<b>C</b> 3/2 way valve NC 	G ⅛	G ¼	1.5	75	PA	0...10	5	784710	x	x
		G ¼	2.0	120	PA	0...10	8	784706	784707	784709
		G ¼	2.5	174	PA	0...6	8	786014	x	786015

**Please note** that the cable plug has to be ordered separately, see separate datasheet for Type 2508.

x on request

Materials for ATEX/IECEX m cable version

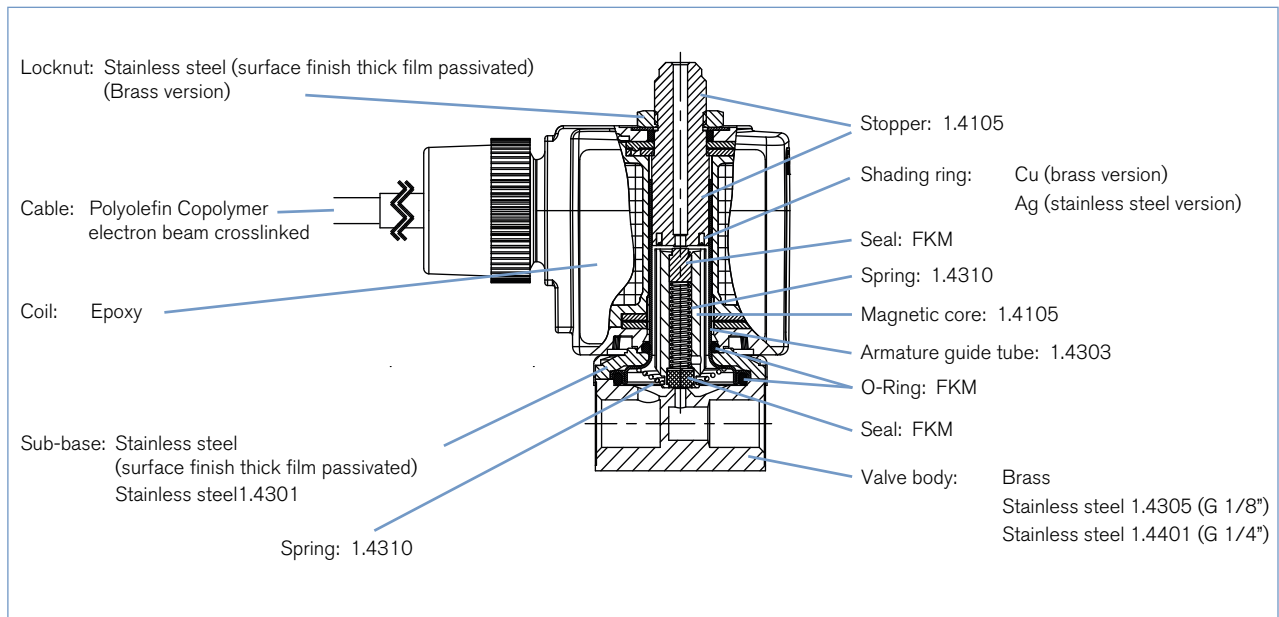

Dimensions for ATEX/IECEx m cable version

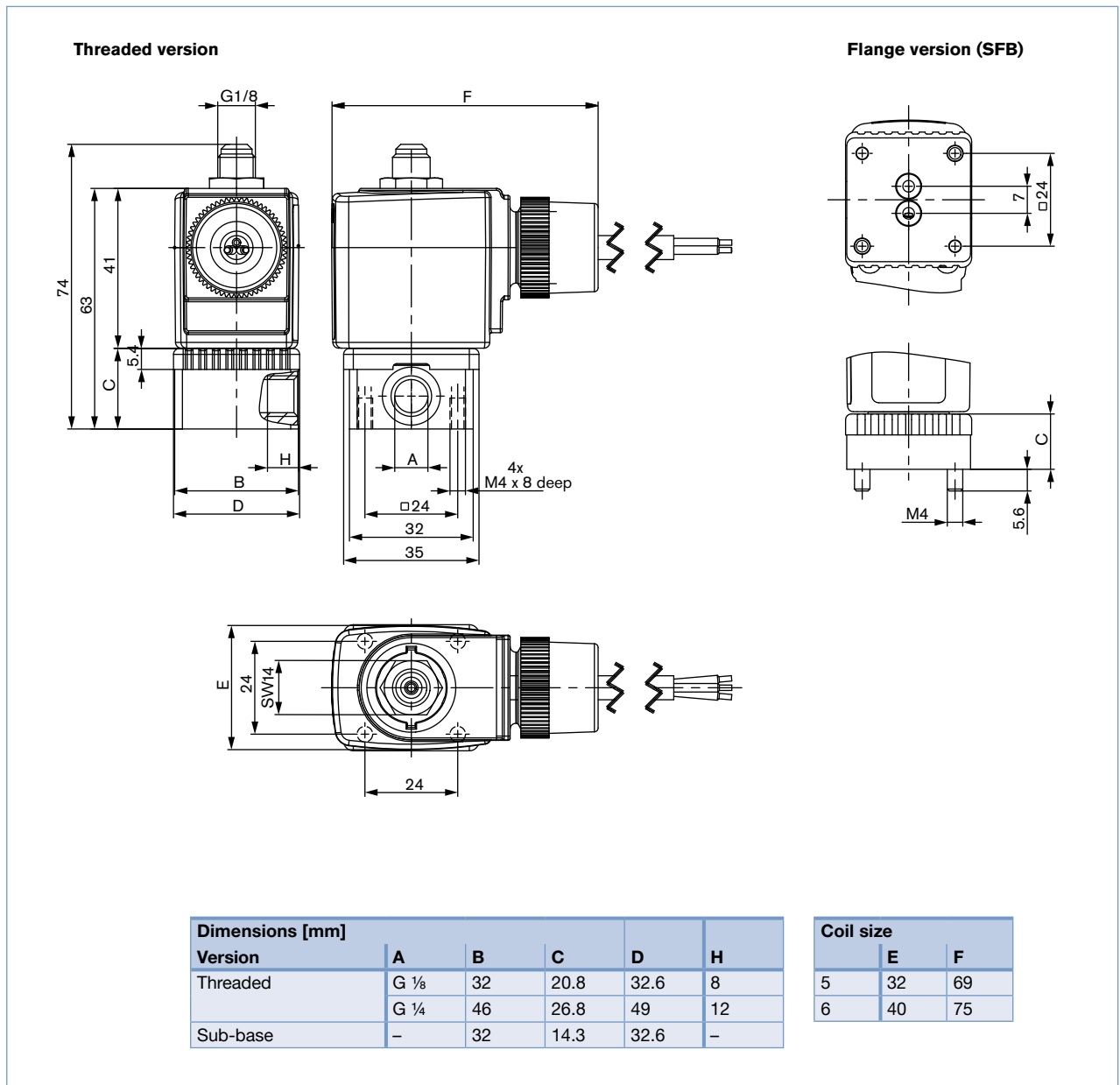

## Ordering chart for Ex m valves cable version

6014 valve, Ex m II T4, with FKM seal material and sub-base (SFB) connection with 3 m moulded cable approved for block mounting, ambient temperature from -10 °C to +40 °C

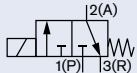
Circuit function	Orifice [mm]	Port connection	K <sub>v</sub> value water [m <sup>3</sup> /h]	Pressure range [bar]	Body material	Effective coil power [W]	Voltage/frequency [V/Hz]	Article no. with manual override
<b>C</b> 3/2 way valve NC 	1.5	sub-base (SFB)	0.07	0...10	PA	7	024/UC	278651
							230/UC	278653
	2.0	sub-base (SFB)	0.11	0...6	Brass	7	024/UC	278655
							230/UC	278656
					Brass	7	024/UC	278658
						230/UC	278659	

6014 valve, Ex m II T4, with FKM seal material and threaded connection with 3 m moulded cable approved for single mounting, ambient temperature from -10 °C to +55 °C

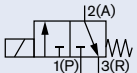
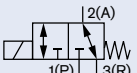
Circuit function	Orifice [mm]	Port connection	K <sub>v</sub> value water [m <sup>3</sup> /h]	Pressure range [bar]	Body material	Effective coil power [W]	Voltage/frequency [V/Hz]	Article no. without manual override	Article no. with manual override	
<b>C</b> 3/2 way valve NC 	2.0	G 1/8	0.11	0...10	Brass	9	024/UC	278637	278645	
							230/UC	278638	278646	
		Stainless steel					9	024/UC	278660	x
							9	230/UC	278661	x
		G 1/4	0.11	0...10	Brass	9	024/UC	278639	278647	
							230/UC	278641	278649	
	Stainless steel					9	024/UC	278662	x	
						9	230/UC	278663	x	
	2.5	G 1/8	0.16	0...6	Brass	9	024/UC	x	x	
							230/UC	x	x	
G 1/4		0.16	0...6	Brass	9	024/UC	278643	278673		
						230/UC	278644	x		
<b>T</b> 3/2 way Universal valve 	1.5	G 1/8	0.07	0...7	Brass	9	024/UC	278650	x	
							230/UC	x	x	
		Stainless steel					9	024/UC	278664	x
							9	230/UC	278665	x
	G 1/4	0.07	0...7	Brass	9	024/UC	x	x		
						230/UC	x	x		
		Stainless steel					9	024/UC	278666	x
							9	230/UC	x	x

x on request

The maximum fluid temperature must not in any case exceed the permissible temperature class (T4 135 °C, 100 °C T5, T6 85 °C), minus 5 K.

#### ATEX and IECEx approval for coils with fixed cable outlet

ATEX: PTB 14 ATEX 2023 X  
 II 2G Ex mb IIC T4 Gb  
 II 2D Ex mb IIIC T135 °C Db

IECEx: IECEx PTB 14.0049 X  
 Ex mb IIC T4 Gb  
 Ex mb IIIC T135 °C Db

Materials for ATEX/IECEX m junction box version

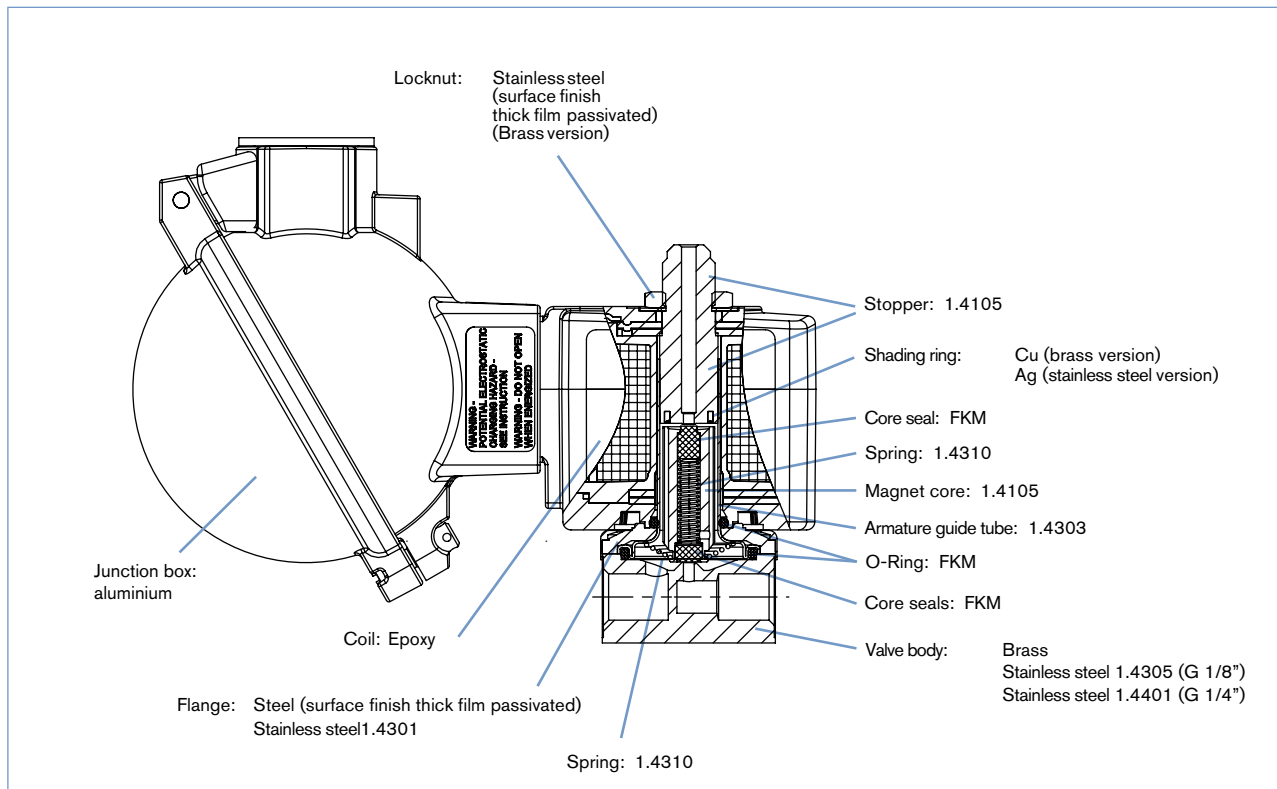

## Dimensions for ATEX/IECEx m junction box version

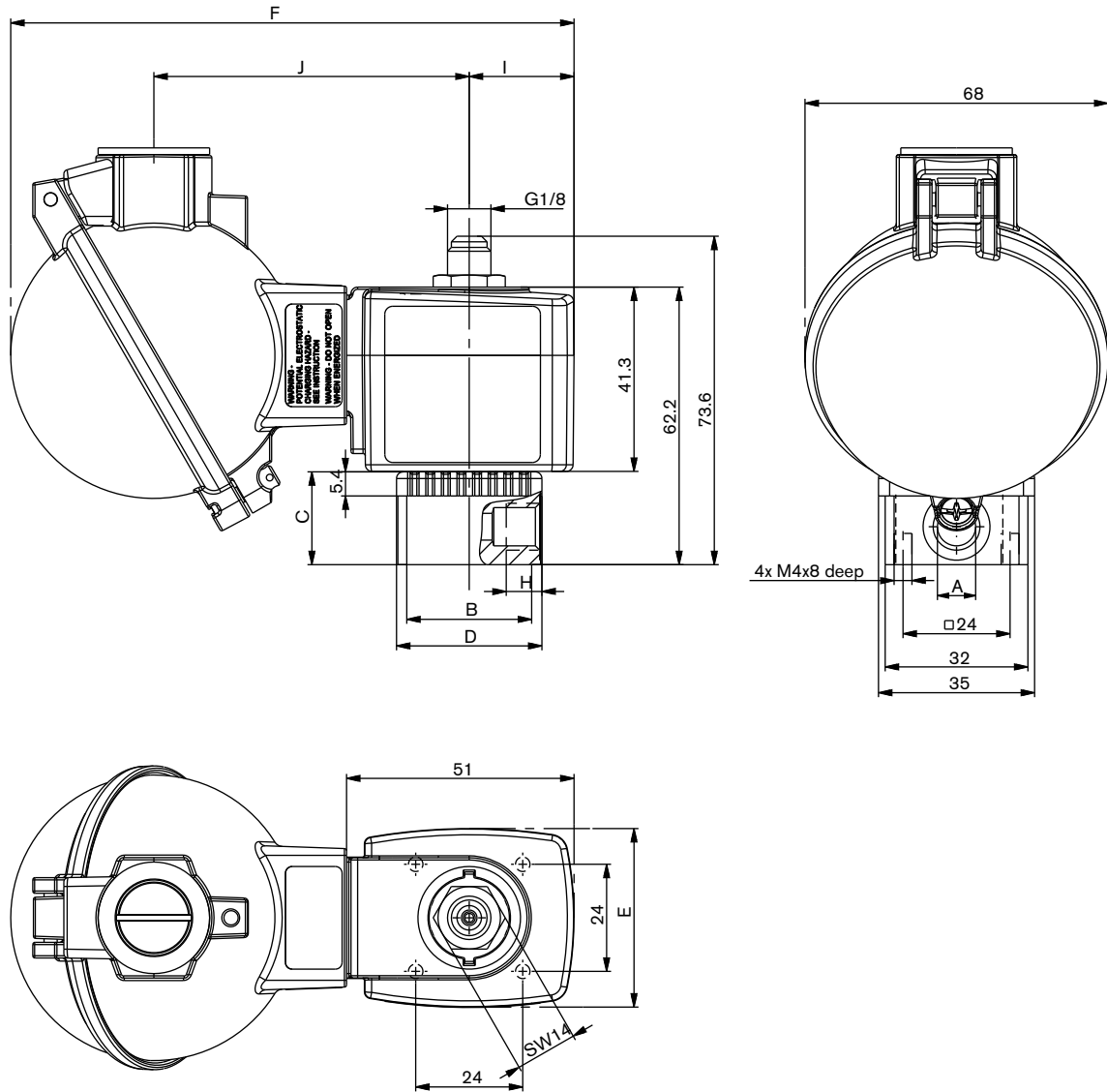

Dimensions [mm]					
Version	A	B	C	D	H
Threaded	G 1/8	32	20.8	32.6	8
	G 1/4	46	26.8	49	12
Flange	-	32	14.3	32.6	-

Coil size	E [mm]	F	I	J
5	32	120.3	20.5	69
6	40	126.3	23.5	70.7

## Ordering chart for Ex m valves junction box version

6014 valve , Ex m II T4, with seal material FKM and flange connection (SFB) Junction box for block mounting available, ambient temperature from - 10 °C to +40 °C

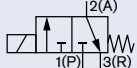
Circuit function	Orifice [mm]	Port connection	K <sub>v</sub> value water [m <sup>3</sup> /h]	Pressure range [bar]	Body material	Coil effective power	Voltage/Frequency [V/Hz]	Article no. with manual override
<b>C</b> 3/2 way valve NC 	1.5	sub-base (SFB)	0.07	0 ... 10	PA	7	024/UC	288562
							230/UC	288563
	2.0	sub-base (SFB)	0.11	0 ... 6	Brass	7	024/UC	x
							230/UC	x

x on request

6014 valve, Ex m II T4, with seal material FKM and threaded connection with junction box only for single mounting available, ambient temperature form - 10 °C to +55 °C

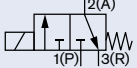
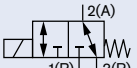
Circuit function	Orifice [mm]	Port connection	K <sub>v</sub> value water [m <sup>3</sup> /h]	Pressure range [bar]	Body material	Coil effective power	Voltage/Frequency [V/Hz]	Article no. without manual override	Article no. with manual override	
<b>C</b> 3/2 way valve NC 	2.0	G 1/8	0.11	0 ... 10	Brass	9	024/UC	288470	288491	
							230/UC	288490	288566	
			G 1/4	0.11	0 ... 10	Stainless steel	9	024/UC	288488	x
						230/UC		288497	x	
		G 1/8	0.16	0 ... 6	Brass	9	024/UC	288471	288475	
					230/UC		288516	288519		
		G 1/4	0.16	0 ... 6	Stainless steel	9	024/UC	288486	x	
					230/UC		288500	x		
<b>T</b> 3/2 way Universal valve 	1.5	G 1/8	0.07	0 ... 7	Brass	9	024/UC	288511	x	
							230/UC	x	x	
		G 1/4	0.07	0 ... 7	Stainless steel	9	024/UC	x	x	
					230/UC		x	x		
		G 1/8	0.16	0 ... 6	Brass	9	024/UC	x	x	
					230/UC		x	x		
	G 1/4	0.16	0 ... 6	Stainless steel	9	024/UC	288489	x		
				230/UC		288506	x			

x on request

The maximum fluid temperature must not in any case exceed the permissible temperature class (T4 135 °C, 100 °C T5, T6 85 °C), minus 5 K.

## ATEX and IECEx approval for the assembly of the coil and the junction box

ATEX: EPS 16 ATEX 1046 X

IECEX: IECEX EPS 16.0021 X

II 2G Ex eb mb IIC T4 Gb





Ex eb mb IIC T4 Gb

II 2D Ex mb tb IIIC T130 °C Db

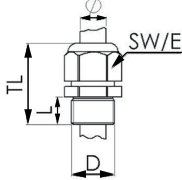

Ex mb tb IIIC T130 °C Db

## Ex-Cable glands

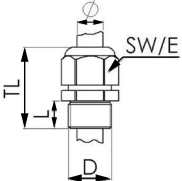
(polyamide version included in delivery / surcharge applied for brass nickel plated version)

Photo	Description	Ex Approvals Certification	Identification	Article no	Drawing										
	Brass, nickel- plated, 6... 13 mm	PTB 04 ATEX 1112 X, IECEX PTB 13.0027X	II 2 G Ex e IIC Gb, II 2 D Ex tb IIIC Db IP68,	773278 	 <table border="1"> <tr><td>TL</td><td>29... 37 mm</td></tr> <tr><td>L</td><td>6 mm</td></tr> <tr><td>D</td><td>20</td></tr> <tr><td>SW</td><td>24 mm</td></tr> <tr><td>E</td><td>27 mm</td></tr> </table>	TL	29... 37 mm	L	6 mm	D	20	SW	24 mm	E	27 mm
TL	29... 37 mm														
L	6 mm														
D	20														
SW	24 mm														
E	27 mm														
	Polyamide, 7... 13 mm	PTB 13 ATEX 1015 X, IECEX PTB 13.0034X	II 2 G Ex e IIC Gb, II 2 D Ex tb IIIC Db IP68	773277 	 <table border="1"> <tr><td>TL</td><td>36... 45 mm</td></tr> <tr><td>L</td><td>10 mm</td></tr> <tr><td>D</td><td>20</td></tr> <tr><td>SW</td><td>24 mm</td></tr> <tr><td>E</td><td>28 mm</td></tr> </table>	TL	36... 45 mm	L	10 mm	D	20	SW	24 mm	E	28 mm
TL	36... 45 mm														
L	10 mm														
D	20														
SW	24 mm														
E	28 mm														

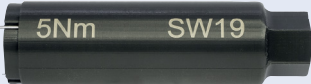
## Special tool to turn the junction box (not included in delivery)

Photo	Description	Article no.
	Set SC02-AC10 Special wrench Service Manual	293488 



## Materials for ATEX/IECEX ia

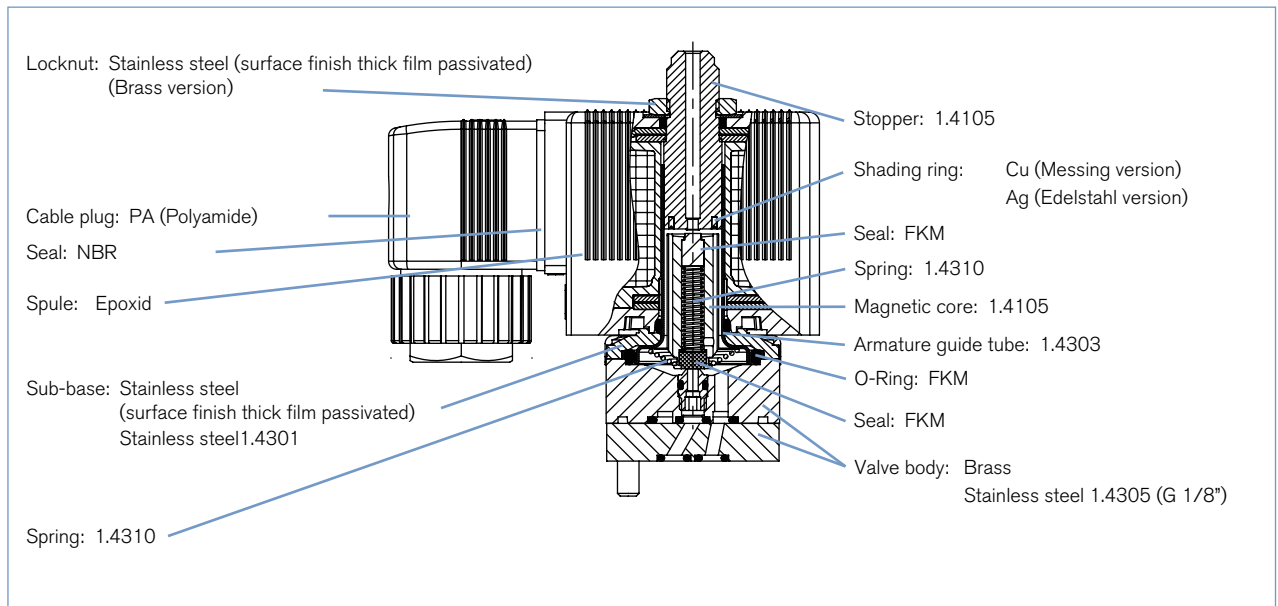

## Dimensions for ATEX/IECEX ia [mm]

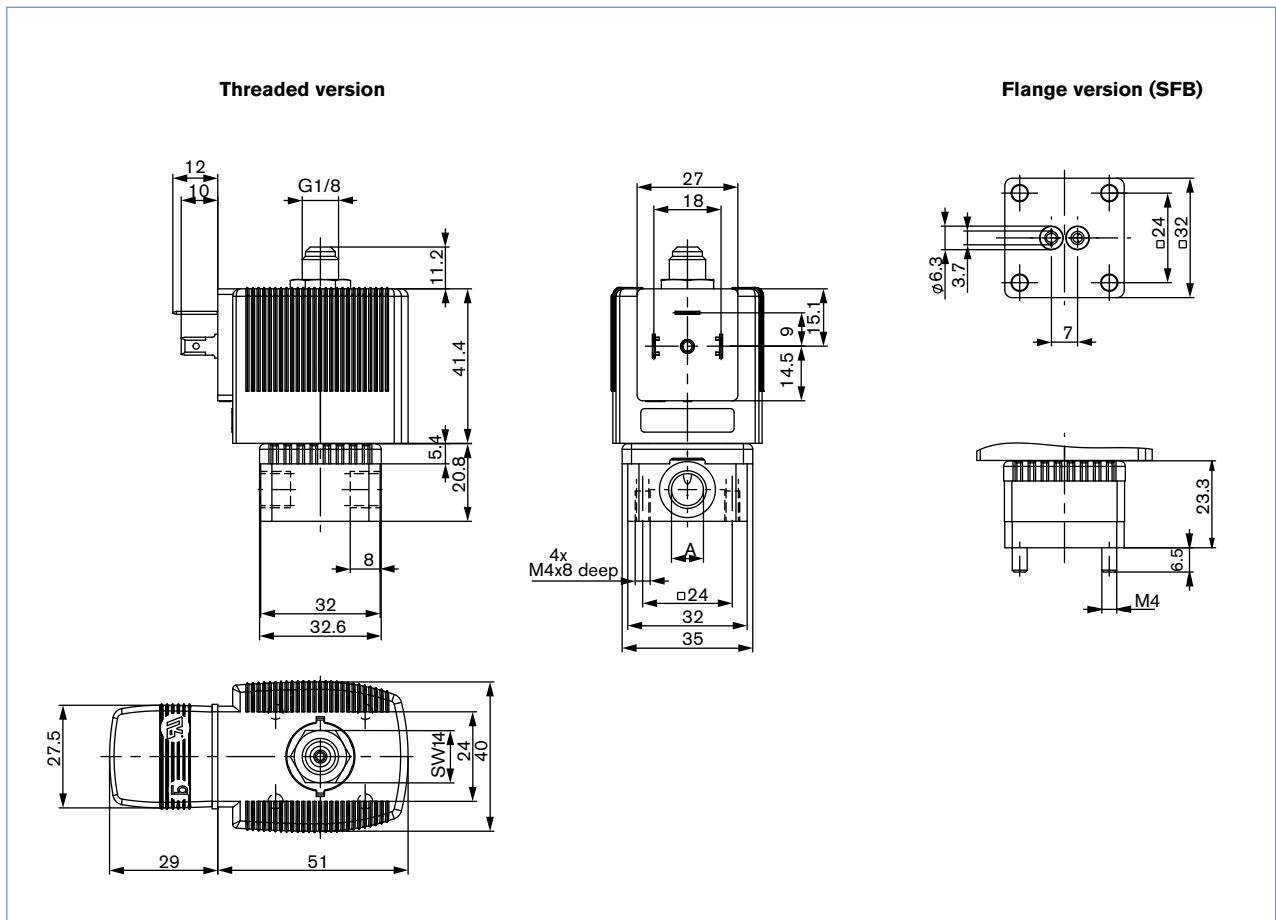

## Electrical data

**Type of protection** EEx ia IIC T6 acc. to PTB-No. Ex-96.D.2010

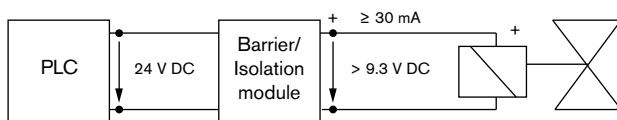

**Note:** The valve is designed to operate on **24 V DC** outputs through an intermediary intrinsically safe apparatus (isolating block or barrier)..

Function values for switching valve	Max. allowable values acc. to the certificate of conformity	
	at +20 °C	at +55 °C
Minimum switching current	30 mA	30 mA
Nominal resistance coil	310 $\Omega$	360 $\Omega$
Minimum terminal voltage	9.3 V	10.8 V

Function values for switching valve		Max. allowable values acc. to the certificate of conformity	
		at +20 °C	at +55 °C
Ui		28 V	
li		120 mA	
Pi		1.1 W	
Ambient temperature		+60 °C at T6	+75 °C at T5

## Technical data - ATEX/IECEEx -ia

### Response times

Response times	
Opening [ms]	Closing [ms]
20	22

**Response times [ms]:**

Measured at valve outlet at 6 bar and +20 °C

Opening: Pressure build-up 0...90 %,

Closing: Pressure drop 100...10 %

### Ordering chart - ATEX/IECEEx -ia

6014 valve; Ex ia II T6 with FKM seal material only for approved single mounting, cable plug acc. to DIN EN 175 301 - 803 Form A, ambient temperature from -10 °C to 60 °C for T6, -10... -75 °C for T5

Circuit function	Orifice [mm]	$Q_{Nn}$ -value air [l/min]	Pressure range [bar]	Body material	Port connection	Article no.
<b>C</b> 3/2 way valve NC 	0.9	30	Vac. to 10	Stainless steel	Bürkert sub-base (SFB)	144540
					G 1/8	147226
				Brass	Bürkert sub-base (SFB)	147227
					G 1/8	146214

The maximum fluid temperature must not in any case exceed the permissible temperature class (T4 135 °C, 100 °C T5, T6 85 °C), minus 5 K.

**Explosion-proof approvals**

ATEX: PTB 01 ATEX 2101 0102

II 2G Ex i IIC T6 Gb

II 2D Ex i IIIIC T85 °C Db

PTB IECEX12.0040

Ex ia IIC T6 Gb









Ex ia IIC T80 °C Db

### Ordering chart for accessories

#### Cable plug Type 2508 acc. to DIN EN 175 301 - 803 Form A

	Circuit	Voltage / frequency	Article no.
	without circuitry	0...250 V	438574

## Ordering chart for Manifolds

Accessory parts	Features				Article no.
Single manifold	in aluminium black anodized				005020 
Multiple manifold	in aluminium	Hole spacing A [mm]	Total length B [mm]	Hole spacing C [mm]	
	2 valves	57	65	–	005023 
	3 valves	90	98	–	005286 
	4 valves	123	131	–	005287 
	5 valves	156	164	57	005035 
	6 valves	189	197	57	005038 
	8 valves	255	263	90	005386 
	10 valves	321	329	90	005764 
Covering plate	with plugs and O-ring, for closing off unused valve positions				005630 

Manifolds in Brass or stainless steel on request

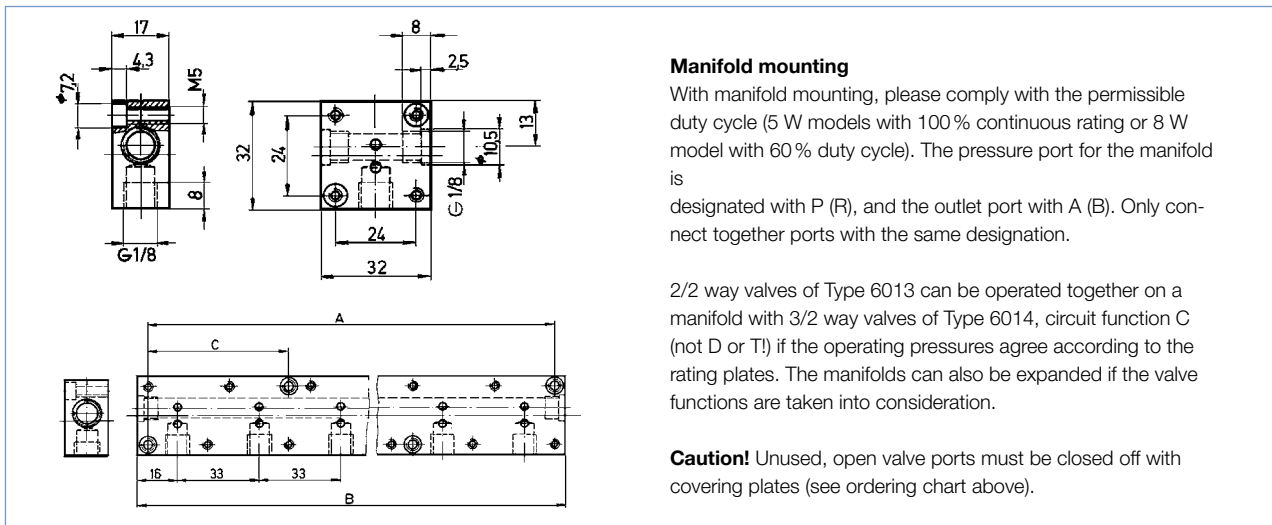
**Manifold mounting**





With manifold mounting, please comply with the permissible duty cycle (5 W models with 100 % continuous rating or 8 W model with 60 % duty cycle). The pressure port for the manifold is designated with P (R), and the outlet port with A (B). Only connect together ports with the same designation.

2/2 way valves of Type 6013 can be operated together on a manifold with 3/2 way valves of Type 6014, circuit function C (not D or T!) if the operating pressures agree according to the rating plates. The manifolds can also be expanded if the valve functions are taken into consideration.

**Caution!** Unused, open valve ports must be closed off with covering plates (see ordering chart above).

## Ordering chart for accessory

## Cable plug Type 2508 according to DIN EN 175 301 - 803 Form A

	Circuitry	Voltage/ Frequency	Article no.
	None (standard)	0 ... 250 V AC/DC	008376 
	with LED	12 ... 24 V AC/DC	008360 
	with LED and varistor	12 ... 24 V AC/DC	008367 
	with LED and varistor	200 ... 240 V	008369 
	with inverter <sup>1)</sup>	24 V DC	on request
further versions see datasheet Type 2508			

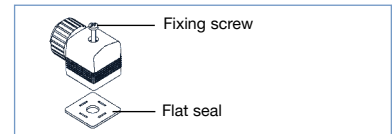





The delivery of a cable plug includes the flat seal and the fixing screw. For other cable plug versions, see separate datasheet Type 2508. Click on the box "More info." and you will come to our website for this product where you can download the datasheet.

**More info.**

<sup>1)</sup> The inverter plug includes an electronic which is specially adapted for an electrical control with 3 wires  
Input 3 wire technology, common "-" polarity, two split "+" polarity.  
Output suitable for impulse model for Type 6013/6014

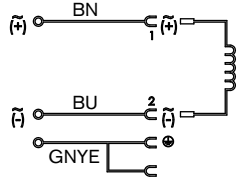
## Cable plug Type 2513 acc. to DIN EN 175 301 - 803, Form A

Meets the requirements of ATEX category 3 GD

		Cable length [mm]	Article no. [in mm]
		12000	260893 
		5000	260892 
		3000	260891 
		300	260890 

**i** Further versions on request



**Materials**

Epoxy coil according to Form A  
Seal material EPDM



**Voltage**

Non-standard voltages



**Port connection**

With banjo nut



**Approvals**

ATEX, UL, CSA



**Additional**

Orifice: 1.2 mm, 3.0 mm

To find your nearest Bürkert facility, click on the orange box →

[www.burkert.com](http://www.burkert.com)

In case of special application conditions,  
please consult for advice.

Subject to alterations  
© Christian Bürkert GmbH & Co. KG

1804/10\_EU-en\_00895091